

COLLECTIONS  
024/025

GAZZINI  
CERAMICA & DESIGN

## CATALOGO GENERALE 2024-2025

Introduzione	2	Iconic Blue	158	Positano Blue	344
Guida Al Catalogo	8	Indian Sunset	164	Premium Onyx	350
Indice Analitico	10	La Réserve	170	Quarz	356
Amalfi Lux	12	Lava Stone	178	Royal Marbles	372
Antique Portofino	18	Les Bois	192	Slide	380
Artwork	24	Luxury Grey	200	Stage	390
Atelier	44	Macchia Antica	206	Stat One	400
Atlantic Blue	54	Marmobianco	212	Stone Selection	408
Avenue White	60	Marquinia Black	218	Stylish Taupe	422
Blauwsteen	66	Met	224	Tinteunite	428
Calacatta Emerald	72	Midnight Blue	232	Tropical Breeze	434
Calacatta Oro	78	Monolith	238	Venato Select	440
Color Art	84	Move	254	Venice Black	448
Cortina White	94	My Art	268	White Beauty	454
Deco Style	100	Nexxt	274	White Dolomite	460
Factory	108	New Arabescato	296	White Onyx	468
Florence Grey	120	New Moonlight	302	Condizioni generali di vendita	476
Flow	126	New Style Dark	308		
Fossil	140	Opus Stone	314		
Fusion	144	Platform	324		

C O L L E C T I O N S

2 0 2 4 - 2 0 2 5

C A T A L O G O

G E N E R A L E

**For over 50 years,  
a journey into the world of  
design.**

Since 1965, Gazzini has stood out as an Italian company specialized in the creation of porcelain stoneware solutions, capable of responding to all needs in the field of architecture and interior design.

A brand recognized for its excellence in the production of floors and walls, Gazzini has been a point of reference in the panorama of Italian creativity and design in the ceramic sector for fifty years.

**Depuis plus de 50 ans,  
un voyage dans le monde du  
design.**

Depuis 1965, Gazzini se distingue comme une entreprise italienne spécialisée dans la création de solutions en grès cérame, capable de répondre à tous les besoins dans le domaine de l'architecture et de la décoration d'intérieur.

Marque reconnue pour son excellence dans la production de sols et de murs, Gazzini est depuis cinquante ans un référent dans le panorama de la créativité et du design italien dans le secteur de la céramique.

**Seit über 50 Jahren  
eine Reise in die Welt des  
Designs.**

Seit 1965 ist Gazzini ein italienisches Unternehmen, das sich auf die Herstellung von Lösungen aus Feinsteinzeug spezialisiert hat und in der Lage ist, alle Anforderungen im Bereich Architektur und Innenarchitektur zu erfüllen.

Gazzini ist eine Marke, die für ihre Exzellenz in der Herstellung von Böden und Wänden bekannt ist und seit 50 Jahren ein Bezugspunkt im Panorama der italienischen Kreativität und des italienischen Designs im Keramiksektor ist.

# Da oltre cinquant'anni, un viaggio nel mondo del design.

Sin dal 1965, Gazzini si distingue come un'azienda italiana specializzata nella creazione di soluzioni in gres porcellanato, in grado di rispondere a tutte le necessità nel campo dell'architettura e del design d'interni.

Marchio riconosciuto per la sua eccellenza nella produzione di pavimenti e rivestimenti, Gazzini da ben 50 anni rappresenta un punto di riferimento nel panorama della creatività e del design italiano nel settore ceramico.



**GAZZINI**  
CERAMICA & DESIGN

**Our products:  
a combination of style  
and design culture.**

Our collections combine extraordinary technical expertise with a deep passion for the ceramic material. We offer extremely flexible solutions with a contemporary touch, highlighted by meticulous attention to detail and a refined aesthetic of pure elegance. Our path through stylistic influences is constantly evolving, opening up new perspectives in the world of design and architecture.

**Nos produits :  
une combinaison de style  
et de culture du design.**

Nos collections allient une expertise technique extraordinaire à une profonde passion pour le matériau céramique. Nous proposons des solutions extrêmement flexibles avec une touche contemporaine, mises en valeur par une attention méticuleuse aux détails et une esthétique raffinée de pure élégance. Notre parcours à travers les influences stylistiques est en constante évolution, ouvrant de nouvelles perspectives dans le monde du design et de l'architecture.

**Unsere Produkte:  
eine Kombination aus  
Stil und Designkultur.**

Unsere Kollektionen vereinen außergewöhnliche technische Kompetenz mit einer tiefen Leidenschaft für das Keramikmaterial. Wir bieten äußerst flexible Lösungen mit einem zeitgemäßen Touch, hervorgehoben durch viel Liebe zum Detail und eine raffinierte Ästhetik purer Eleganz. Unser Weg durch stilistische Einflüsse entwickelt sich ständig weiter und eröffnet neue Perspektiven in der Welt des Designs und der Architektur.

# I nostri prodotti: connubio di stile e cultura del design.

Le nostre collezioni coniugano una straordinaria competenza tecnica con una profonda passione per la materia ceramica. Offriamo soluzioni estremamente flessibili dal tocco contemporaneo, evidenziate da una meticolosa attenzione ai dettagli e una raffinata estetica di pura eleganza. Il nostro percorso attraverso le influenze stilistiche è in costante evoluzione, aprendo nuove prospettive nel mondo del design e dell'architettura.



Relazione,  
innovazione,  
dialogo  
costante.



Know-how



**La nostra capacità di innovare deriva da un confronto costruttivo e quotidiano con i nostri partner.** La nostra filosofia aziendale si basa sulla centralità del cliente, sulla ricerca e sulla sostenibilità. Questi valori, uniti alla nostra capacità di adattarci alle tendenze in evoluzione nell'ambiente abitativo, enfatizzano la qualità e l'affidabilità dei nostri prodotti e delle soluzioni che proponiamo.

# GAZZINI

**Relationship, innovation,  
constant dialogue.**

Our ability to innovate comes from a constructive and daily dialogue with our partners. Our company philosophy is based on customer centricity, research and sustainability. These values, combined with our ability to adapt to evolving trends in the living environment, emphasize the quality and reliability of our products and the solutions we offer.

**Relation, innovation,  
dialogue constant.**

Notre capacité à innover vient d'un dialogue constructif et quotidien avec nos partenaires. Notre philosophie d'entreprise est basée sur l'orientation client, la recherche et la durabilité. Ces valeurs, combinées à notre capacité à nous adapter aux tendances évolutives du cadre de vie, mettent l'accent sur la qualité et la fiabilité de nos produits et des solutions que nous proposons.

**Beziehung, Innovation,  
ständiger Dialog.**

Unsere Innovationsfähigkeit beruht auf einem konstruktiven und täglichen Dialog mit unseren Partnern. Unsere Unternehmensphilosophie basiert auf Kundenorientierung, Forschung und Nachhaltigkeit. Diese Werte, gepaart mit unserer Fähigkeit, sich an sich verändernde Trends im Wohnumfeld anzupassen, unterstreichen die Qualität und Zuverlässigkeit unserer Produkte und der von uns angebotenen Lösungen.

Guida al catalogo • Guide to the catalogue • Guide au catalogue • Hinweisverzeichnis

CATALOGO GENERALE  
2024-2025

codice  
code  
code  
Kode

descrizione e formato  
description and size  
description et format  
Beschreibung und Format

prezzo  
price  
prix  
Preis



**041491**  
TINTEUNITE GREY RETTIFICATO 30X30  
Cod. **78** □

	SCATOLA • BOX • BOITE • KARTON			PALLET • PALLETS • PALETTS • PALETTE		
	pz	mq	kg	box	mq	kg
<b>30x30</b>	11	0,99	23,20	46	45,54	1.090,00

codice  
code  
code  
Kode

descrizione e formato  
description and size  
description et format  
Beschreibung und Format

prezzo  
price  
prix  
Preis



**041488**  
TINTEUNITE GREY MOSAICO 5x5  
SU RETE 30x30 Cod. **24** ○

pezzi per scatola  
pieces each box  
pièces par boîte  
Stückzahl je Karton

peso scatola  
box weight  
poids par boîte  
Gewicht je Karton

codice  
code  
code  
Kode

descrizione e formato  
description and size  
description et format  
Beschreibung und Format

prezzo  
price  
prix  
Preis



6  
12 kg

□ = mq  
○ = pz  
△ = ml

Introduzione	2	Midnight Blue	232
Guida Al Catalogo	8	Monolith	238
Indice Analitico	10	Move	254
Amalfi Lux	12	My Art	268
Antique Portofino	18	Nexxt	274
Artwork	24	New Arabescato	296
Atelier	44	New Moonlight	302
Atlantic Blue	54	New Style Dark	308
Avenue White	60	Opus Stone	314
Blauwsteen	66	Platform	324
Calacatta Emerald	72	Positano Blue	344
Calacatta Oro	78	Premium Onyx	350
Color Art	84	Quarz	356
Cortina White	94	Royal Marbles	372
Deco Style	100	Slide	380
Factory	108	Stage	390
Florence Grey	120	Stat One	400
Flow	126	Stone Selection	408
Fossil	140	Stylish Taupe	422
Fusion	144	Tinteunite	428
Iconic Blue	158	Tropical Breeze	434
Indian Sunset	164	Venato Select	440
La Réserve	170	Venice Black	448
Lava Stone	178	White Beauty	454
Les Bois	192	White Dolomite	460
Luxury Grey	200	White Onyx	468
Macchia Antica	206	Condizioni generali di vendita	476
Marmobianco	212		
Marquinia Black	218		
Met	224		

CATALOGO  
GENERALE

2024-2025

Indice analitico • Analytical index • Index analytique • Sachverzeichnis

AMALFI LUX	Amalfi Lux	14
ANTIQUE PORTOFINO	Antique Portofino	20
ARTWORK	Artwork Grigio	26
ARTWORK	Artwork Piombo	30
ARTWORK	Artwork Sabbia	34
ARTWORK	Artwork Tortora	38
ATELIER	Atelier Grey	46
ATELIER	Atelier Ivory	47
ATELIER	Atelier White	48
ATELIER	Atelier Beige	49
ATLANTIC BLUE	Atlantic Blue	56
AVENUE WHITE	Avenue White	62
BLAUWSTEEN	Blauwsteen	68
CALACATTA EMERALD	Calacatta Emerald	74
CALACATTA ORO	Calacatta Oro	80
COLOR ART	Color Art Deep Green	86
COLOR ART	Color Art Burgundy	86
COLOR ART	Color Art Light Pink	86
COLOR ART	Color Art Dark Taupe	87
COLOR ART	Color Art Turquoise	87
COLOR ART	Color Art Blue	87
COLOR ART	Color Art White	88
COLOR ART	Color Art Greige	88
COLOR ART	Color Art Black	88
COLOR ART	Color Art White Matt	89
COLOR ART	Color Art Greige Matt	89
COLOR ART	Color Art Black Matt	89
CORTINA WHITE	Cortina White	96
DECO STYLE	Deco Style White	102
DECO STYLE	Deco Style Beige	103
DECO STYLE	Deco Style Grey	104
DECO STYLE	Deco Style Charcoal	105
FACTORY	Factory White	110
FACTORY	Factory Grey	112

FACTORY	Factory Smoke	114
FACTORY	Factory Black	116
FLORENCE GREY	Florence Grey	122
FLOW	Flow Grey	128
FLOW	Flow Taupe	130
FLOW	Flow Mud	132
FLOW	Flow Ivory	134
FLOW	Flow Beige	136
FOSSIL	Fossil	142
FUSION	Fusion Antracite	146
FUSION	Fusion Beige	148
FUSION	Fusion Bianco	150
FUSION	Fusion Grigio	152
FUSION	Fusion Tortora	154
ICONIC BLUE	Iconic Blue	160
INDIAN SUNSET	Indian Sunset	166
LA RÉSERVE	La Réserve Beige	172
LA RÉSERVE	La Réserve Greige	173
LA RÉSERVE	La Réserve Ivoire	174
LAVA STONE	Lava Stone Shadow	180
LAVA STONE	Lava Stone Ivory	182
LAVA STONE	Lava Stone Black	184
LAVA STONE	Lava Stone Taupe	186
LES BOIS	Les Bois St. Tropez	194
LES BOIS	Les Bois Antibes	195
LES BOIS	Les Bois Biarritz	196
LUXURY GREY	Luxury Grey	202
MACCHIA ANTICA	Macchia Antica	208
MARMOBIANCO	Marmobianco	214
MARQUINIA BLACK	Marquinia Black	220
MET	Met Antracite	226
MET	Met Brown	227
MET	Met Grey	228
MET	Met Smoke	229

MET	Met White	230
MIDNIGHT BLUE	Midnight Blue	234
MONOLITH	Monolith White	240
MONOLITH	Monolith Taupe	242
MONOLITH	Monolith Grey	244
MONOLITH	Monolith Mud	246
MONOLITH	Monolith Black	248
MOVE	Move Black	256
MOVE	Move Beige	258
MOVE	Move Grey	260
MOVE	Move Ivory	262
MOVE	Move Mud	264
MY ART	My Art Bianco	270
MY ART	My Art Tortora	270
MY ART	My Art Fango	270
MY ART	My Art Nero	270
MY ART	My Art Blu	270
MY ART	My Art Verde	270
MY ART	My Art Bianco Matt	271
MY ART	My Art Tortora Matt	271
MY ART	My Art Fango Matt	271
MY ART	My Art Nero Matt	271
NEXXT	Nexxt Taupe	276
NEXXT	Nexxt Ivory	280
NEXXT	Nexxt Mud	284
NEXXT	Nexxt Grey	288
NEW ARABESCATO	New Arabescato	298
NEW MOONLIGHT	New Moonlight	304
NEW STYLE DARK	New Style Dark	310
OPUS STONE	Opus Stone Avorio	316
OPUS STONE	Opus Stone Grigio	317
OPUS STONE	Opus Stone Beige	318
OPUS STONE	Opus Stone Tortora	319
OPUS STONE	Opus Stone Blu	320

PLATFORM	Platform Powder	326
PLATFORM	Platform Sage	330
PLATFORM	Platform Blue	334
PLATFORM	Platform Bronze	338
POSITANO BLUE	Positano Blue	346
PREMIUM ONYX	Premium Onyx	352
QUARZ	Quarz Antracite	358
QUARZ	Quarz Beige	360
QUARZ	Quarz Green	362
QUARZ	Quarz Grey	364
QUARZ	Quarz Taupe	366
ROYAL MARBLES	Royal Marbles Light Bardiglio	374
ROYAL MARBLES	Royal Marbles Marfil Select	376
SLIDE	Slide Black	382
SLIDE	Slide Grey	384
SLIDE	Slide White	386
STAGE	Stage Cozy Blend	392
STAGE	Stage Hipster Blend	394
STAGE	Stage Shabby Chic Blend	396
STAT ONE	Stat One	402
STONE SELECTION	Stone Selection Dark Cloud	410
STONE SELECTION	Stone Selection Dolmen White	412
STONE SELECTION	Stone Selection New Grey	414
STONE SELECTION	Stone Selection Moon Cream	416
STYLISH TAUPE	Stylish Taupe	424
TINTEUNITE	Tinteunite White	430
TINTEUNITE	Tinteunite Grey	431
TINTEUNITE	Tinteunite Black	432
TROPICAL BREEZE	Tropical Breeze	436
VENATO SELECT	Venato Select	442
VENICE BLACK	Venice Black	450
WHITE BEAUTY	White Beauty	456
WHITE DOLOMITE	White Dolomite	462
WHITE ONYX	White Onyx	470





Tipologia  
Type  
Typologie  
Typ  
Gres porcellanato smaltato  
Glazed porcelain  
Grès cérame emaille  
Feinsteinzeug glasiert

Formati  
Sizes  
Formats  
Formate  
60x120  
60x60  
30x60  
10x30

Spessore  
Thickness  
Épaisseur  
Stärke  
9 mm

Resistenza scivolosità  
Sliding resistance  
Resistance au glissement  
Rutschfestigkeit  
R9

Grado di variazione cromatica  
Degree of colour change  
Degré de variation chromatique  
Grad der Farbabweichung  
V3



**0601326**  
AMALFI LUX  
RETTIFICATO 60x120  
Cod. **94** □

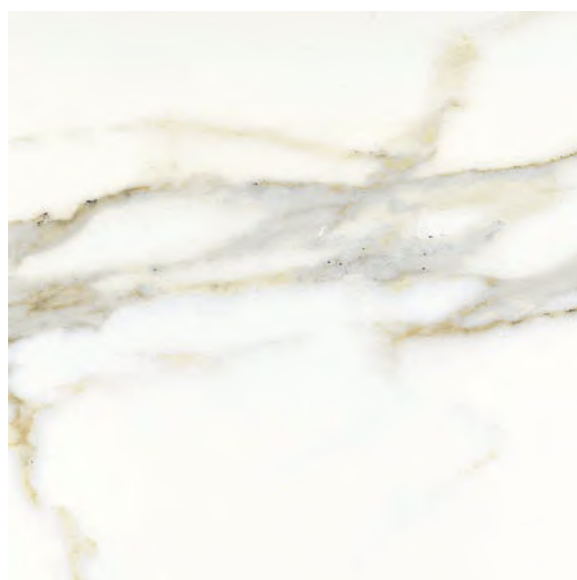

**0606272**  
AMALFI LUX  
RETTIFICATO 60x60  
Cod. **87** □



**0490823**  
AMALFI LUX  
RETTIFICATO 30x60  
Cod. **79** □



**0103153**  
AMALFI LUX  
RETTIFICATO 10x30  
Cod. **87** □

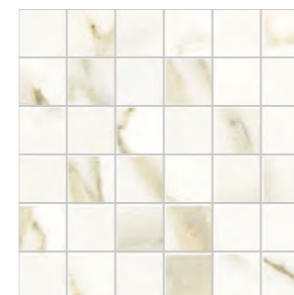

6  
9,70 kg

**0041425**  
AMALFI LUX  
MOSAICO 5x5 SU RETE 30x30  
Cod. **26** ○



6  
8,90 kg

**0041433**  
AMALFI LUX  
MOSAICO ESAGONO SU RETE 27x28  
Cod. **45** ○



6  
9,80 kg

**0041441**  
AMALFI LUX  
MOSAICO HB SU RETE 28x32  
Cod. **46** ○



6  
9,80 kg

**0041450**  
AMALFI LUX  
MOSAICO ANTIQUE LUX SU RETE 30x30  
Cod. **69** ○

IMBALLI • PACKAGES • EMBALLAGES • FORMATE

	SCATOLA • BOX • BOITE • KARTON			PALLET • PALLETS • PALETTS • PALETTE		
	<i>pz</i>	<i>mq</i>	<i>kg</i>	<i>box</i>	<i>mq</i>	<i>kg</i>
<b>60x120</b>	2	1,44	28,70	30	43,20	861,00
<b>60x60</b>	3	1,08	21,50	40	43,20	861,00
<b>30x60</b>	6	1,08	21,50	40	43,20	861,00
<b>10x30</b>	20	0,60	11,40	60	36,00	684,00



Pezzi speciali • Special trims • Pièces spéciales • Formstücke

Battiscopa 44  
17,20 kg 18  
14,80 kg

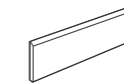

0290841  
AMALFI LUX  
BATTISCOPA 7x30  
Cod. 19 △

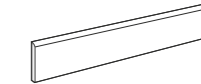

0290849  
AMALFI LUX  
BATTISCOPA 7x60  
Cod. 23 △

CARATTERISTICHE DI QUALITÀ Quality characteristics Caractéristiques de qualité Qualitätseigenschaften	NORMA Norm Norme Norme	REQUISITO NORMA Required standards Valeur prescrite selon la norme Normvorgabe	RISULTATO Result Résultat Ergebniss
Assorbimento d'acqua Water absorption of the body Absorption d'eau de support Wasseraufnahme des Scherbens	ISO 10545-3	≤ 0,5	Conforme Conformity Conforme Gemäss
Resistenza a flessione Breaking strenght Résistance à la flexion Biegefestigkeit	ISO 10545-4	≥ 35 N/mm <sup>2</sup>	Conforme Conformity Conforme Gemäss
Resistenza all'abrasione Abrasion resistance Resistance a l'abrasion Abriebbeständigkeit	ISO 10545-7		PEI IV
Resistenza al gelo Frost resistance Résistance au gel Frostbeständigkeit	ISO 10545-12	Nessun campione deve presentare rotture o alterazioni apprezzabili alla superficie No samples must show ruptures or noticeable surface alteration Aucuns enchantions doit présenter ruptures ou altérations appréciables de la surface Keines der Muster sollte Risse oder sichtbare Fehler der Oberfläche zeigen	Conforme Conformity Conforme Gemäss
Resistenza all'attacco chimico Chemical resistance Résistance à l'attaque chimique Beständigkeit gegen chemikalien	ISO 10545-13		GA GLA
Resistenza agli sbalzi termici Thermal shock resistance Resistance aux écarts de température Temperaturwechselbeständigkeit	ISO 10545-5		Conforme Conformity Conforme Gemäss
Resistenza scivolosità Sliding resistance Resistance au glissement Rutschfestigkeit	DIN 51130 R		R9
Coefficiente d'attrito dinamico Wet dynamic coefficient of friction Coefficient de friction dynamique Reibungskoeffizient Schlupfrigkeit (in Bewegung)	Bot 3000 E	DCOF ≥ 0,42	> 0,42
Significativa variazione Significant variation Variation important Bedeutsam Abweichung			V3

V1  
Aspetto uniforme  
Uniform appearance  
Aspect uniforme  
Einheitliches Aussehen

V2  
Lieve variazione  
Slight variation  
Légère variation  
Geringe Abweichung

V3  
Significativa variazione  
Significant variation  
Variation important  
Bedeutsam Abweichung

V4  
Forte stonalizzazione  
Substantial variation  
Effet dénuancé très accentué  
Akzentuierte Variation

**PER UNA POSA OTTIMALE DEL PRODOTTO CONSIGLIAMO SEMPRE DI MESCOLARE ALMENO TRE SCATOLE DI MATERIALE.**

For the best product laying results, material from at least three boxes should be mixed.

Pour une pose excellente, nous recommandons toujours de mélanger le contenu d'au moins trois boîtes.

Für eine optimale Verlegung des Erzeugnisses empfehlen wir stets, mindestens drei Packungen Material anzumischen.



Tipologia  
Type  
Typologie  
Typ  
Gres porcellanato smaltato  
Glazed porcelain  
Grès cérame emaille  
Feinsteinzeug glasiert

Formati  
Sizes  
Formats  
Formate  
60x120  
60x60  
30x60  
10x30

Spessore  
Thickness  
Épaisseur  
Stärke  
9 mm

Resistenza scivolosità  
Sliding resistance  
Resistance au glissement  
Rutschfestigkeit  
R9

Grado di variazione cromatica  
Degree of colour change  
Degré de variation chromatique  
Grad der Farbabweichung  
V3



**0601319**  
ANTIQUE PORTOFINO  
RETTIFICATO 60x120  
Cod. **94** □



**0606265**  
ANTIQUE PORTOFINO  
RETTIFICATO 60x60  
Cod. **87** □

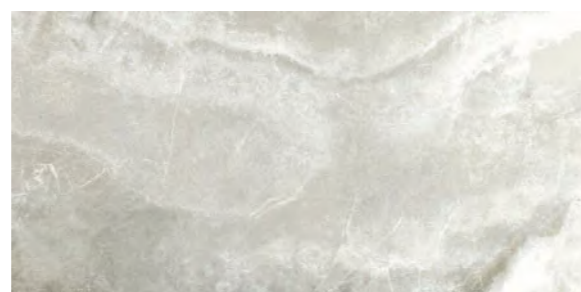

**0490816**  
ANTIQUE PORTOFINO  
RETTIFICATO 30x60  
Cod. **79** □



**0103146**  
ANTIQUE PORTOFINO  
RETTIFICATO 10x30  
Cod. **87** □



6  
9,70 kg

**0041418**  
ANTIQUE PORTOFINO  
MOSAICO 5x5 SU RETE 30x30  
Cod. **26** ○



6  
8,90 kg

**0041426**  
ANTIQUE PORTOFINO  
MOSAICO ESAGONO SU RETE 27x28  
Cod. **45** ○



6  
9,80 kg

**0041434**  
ANTIQUE PORTOFINO  
MOSAICO HB SU RETE 28x32  
Cod. **46** ○



6  
9,80 kg

**0041442**  
ANTIQUE PORTOFINO  
MOSAICO ANTIQUE LUX SU RETE 30x30  
Cod. **69** ○

**IMBALLI • PACKAGES • EMBALLAGES • FORMATE**

	SCATOLA • BOX • BOITE • KARTON			PALLET • PALLETS • PALETTS • PALETTE		
	<i>pz</i>	<i>mq</i>	<i>kg</i>	<i>box</i>	<i>mq</i>	<i>kg</i>
<b>60x120</b>	2	1,44	28,70	30	43,20	861,00
<b>60x60</b>	3	1,08	21,50	40	43,20	861,00
<b>30x60</b>	6	1,08	21,50	40	43,20	861,00
<b>10x30</b>	20	0,60	11,40	60	36,00	684,00



Pezzi speciali • Special trims • Pièces spéciales • Formstücke

Battiscopa

44  
17,20 kg

18  
14,80 kg

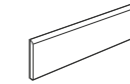

0290834  
ANTIQUE PORTOFINO  
BATTISCOPA 7x30  
Cod. 19 △



0290842  
ANTIQUE PORTOFINO  
BATTISCOPA 7x60  
Cod. 23 △

CARATTERISTICHE DI QUALITÀ Quality characteristics Caractéristiques de qualité Qualitätseigenschaften	NORMA Norm Norme Norme	REQUISITO NORMA Required standards Valeur prescrite selon la norme Normvorgabe	RISULTATO Result Résultat Ergebniss
Assorbimento d'acqua Water absorption of the body Absorption d'eau de support Wasseraufnahme des Scherbens	ISO 10545-3	≤ 0,5	Conforme Conformity Conforme Gemäss
Resistenza a flessione Breaking strenght Résistance à la flexion Biegefestigkeit	ISO 10545-4	≥ 35 N/mm <sup>2</sup>	Conforme Conformity Conforme Gemäss
Resistenza all'abrasione Abrasion resistance Resistance a l'abrasion Abriebbeständigkeit	ISO 10545-7		PEI IV
Resistenza al gelo Frost resistance Résistance au gel Frostbeständigkeit	ISO 10545-12	Nessun campione deve presentare rotture o alterazioni apprezzabili alla superficie No samples must show ruptures or noticeable surface alteration Aucuns enchantions doit présenter ruptures ou altérations appréciables de la surface Keines der Muster sollte Risse oder sichtbare Fehler der Oberfläche zeigen	Conforme Conformity Conforme Gemäss
Resistenza all'attacco chimico Chemical resistance Résistance à l'attaque chimique Beständigkeit gegen chemikalien	ISO 10545-13		GA GLA
Resistenza agli sbalzi termici Thermal shock resistance Resistance aux écarts de température Temperaturwechselbeständigkeit	ISO 10545-5		Conforme Conformity Conforme Gemäss
Resistenza scivolosità Sliding resistance Resistance au glissement Rutschfestigkeit	DIN 51130 R		R9
Coefficiente d'attrito dinamico Wet dynamic coefficient of friction Coefficient de friction dynamique Reibungskoeffizient Schlupfrigkeit (in Bewegung)	Bot 3000 E	DCOF ≥ 0,42	> 0,42
Significativa variazione Significant variation Variation important Bedeutsam Abweichung			V3

V1  
Aspetto uniforme  
Uniform appearance  
Aspect uniforme  
Einheitliches Aussehen

V2  
Lieve variazione  
Slight variation  
Légère variation  
Geringe Abweichung

V3  
Significativa variazione  
Significant variation  
Variation important  
Bedeutsam Abweichung

V4  
Forte stonalizzazione  
Substantial variation  
Effet dénuancé très accentué  
Akzentuierte Variation

**PER UNA POSA OTTIMALE DEL PRODOTTO CONSIGLIAMO SEMPRE DI MESCOLARE ALMENO TRE SCATOLE DI MATERIALE.**

For the best product laying results, material from at least three boxes should be mixed.

Pour une pose excellente, nous recommandons toujours de mélanger le contenu d'au moins trois boîtes.

Für eine optimale Verlegung des Erzeugnisses empfehlen wir stets, mindestens drei Packungen Material anzumischen.



Tipologia  
Type  
Typologie  
Typ  
Gres porcellanato smaltato  
Glazed porcelain  
Grès cérame emaille  
Feinsteinzeug glasiert

Formati  
Sizes  
Formats  
Formate  
120x280  
90x90  
45x90  
60x60  
30x60  
10x60  
10x30  
5x20

Spessore  
Thickness  
Épaisseur  
Stärke  
6 mm  
10 mm

Resistenza scivolosità  
Sliding resistance  
Resistance au glissement  
Rutschfestigkeit  
R10 / A+B

Grado di variazione cromatica  
Degree of colour change  
Degré de variation chromatique  
Grad der Farbabweichung  
V3



120284  
ARTWORK GRIGIO RETTIFICATO 120x280  
Cod. 112 □

⊗ 6 mm





**909040**  
ARTWORK GRIGIO RETTIFICATO 90x90  
Cod. **97** □

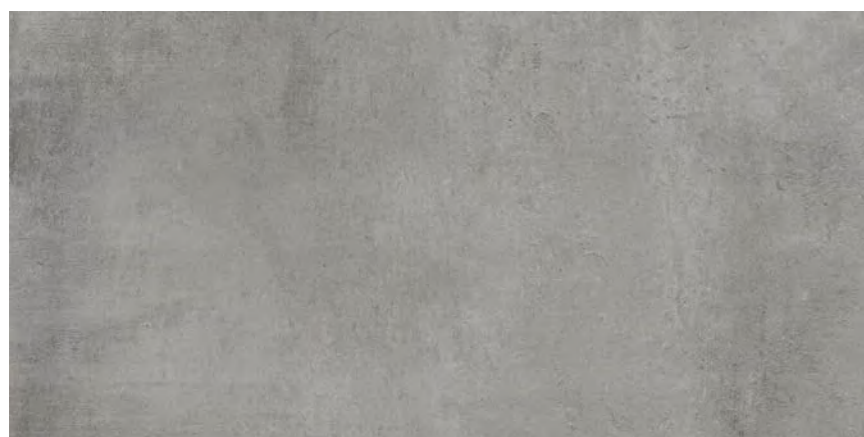

**459031**  
ARTWORK GRIGIO RETTIFICATO 45x90  
Cod. **90** □



6  
12,30 kg

**041201**  
ARTWORK GRIGIO MOSAICO 5x5  
SU RETE 30x30 Cod. **24** ○



6  
12,30 kg

**501146**  
ARTWORK GRIGIO FRAME 2,5x7,5  
SU RETE 30x30 Cod. **28** ○

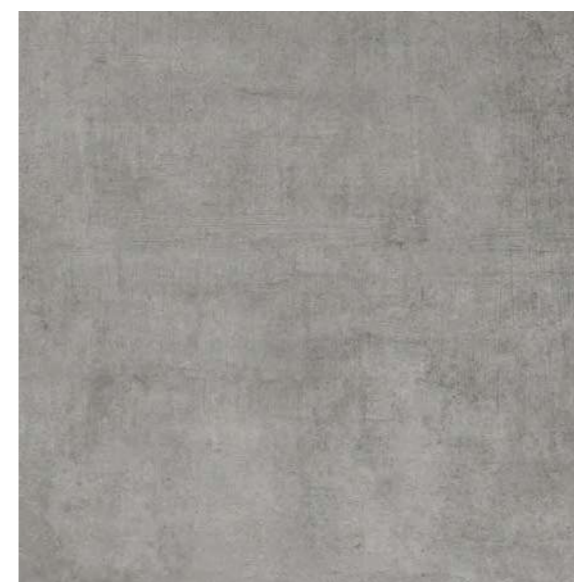

**606214**  
ARTWORK GRIGIO RETTIFICATO 60x60  
Cod. **79** □



**490662**  
ARTWORK GRIGIO RETTIFICATO 30x60  
Cod. **76** □



**106016**  
ARTWORK GRIGIO RETTIFICATO 10x60  
Cod. **83** □



**103121**  
ARTWORK GRIGIO RETTIFICATO 10x30  
Cod. **77** □



4  
7,50 kg

**380282**  
ARTWORK GRIGIO MULTILEVEL SU RETE 19,5x48,8  
Cod. **40** ○



**050227**  
ARTWORK GRIGIO RETTIFICATO 5x20  
Cod. **93** □

IMBALLI • PACKAGES • EMBALLAGES • FORMATE

	SCATOLA • BOX • BOITE • KARTON			PALLET • PALLETS • PALETTS • PALETTE		
	pz	mq	kg	box	mq	kg
<b>90x90</b>	2	1,62	35,95	20	32,40	745,00
<b>45x90</b>	3	1,22	25,20	32	39,04	830,00
<b>60x60</b>	3	1,08	21,20	40	43,20	875,00
<b>30x60</b>	6	1,08	21,00	40	43,20	865,00
<b>10x60</b>	12	0,72	15,40	60	43,20	950,00
<b>10x30</b>	20	0,60	14,00	60	36,00	850,00
<b>5x20</b>	56	0,56	14,00	60	33,60	850,00

	CASSA • CRATE • CAISSE • HOLZKISTE			CAVALLETTO • A-FRAME • CHEVALET • TRANSPORTGESTELL					
	pz	mq	kg	pz	mq	kg			
<b>120x280</b>	1	3,36	47,04	20	67,20	1.090,00	44	147,84	2.220,00



120285  
ARTWORK PIOMBO RETTIFICATO 120x280  
Cod. 112

± 6 mm

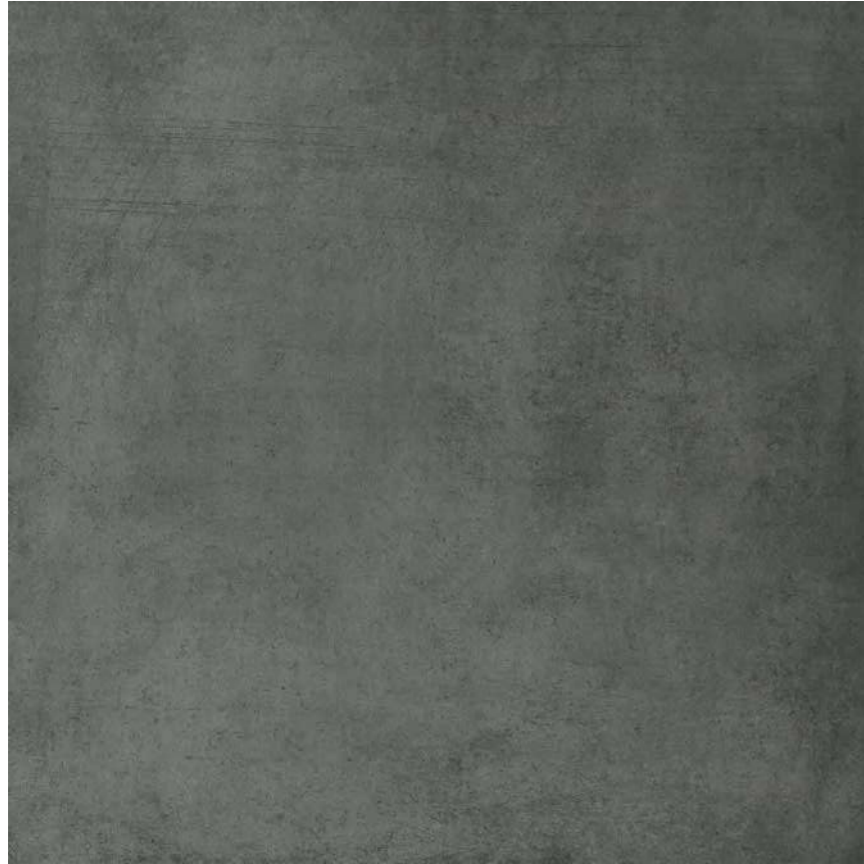

**909042**  
ARTWORK PIOMBO RETTIFICATO 90x90  
Cod. **97** □



**459032**  
ARTWORK PIOMBO RETTIFICATO 45x90  
Cod. **90** □



6  
12,30 kg

**041202**  
ARTWORK PIOMBO MOSAICO 5x5  
SU RETE 30x30 Cod. **24** ○

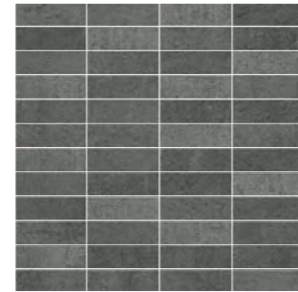

6  
12,30 kg

**501147**  
ARTWORK PIOMBO FRAME 2,5x7,5  
SU RETE 30x30 Cod. **28** ○

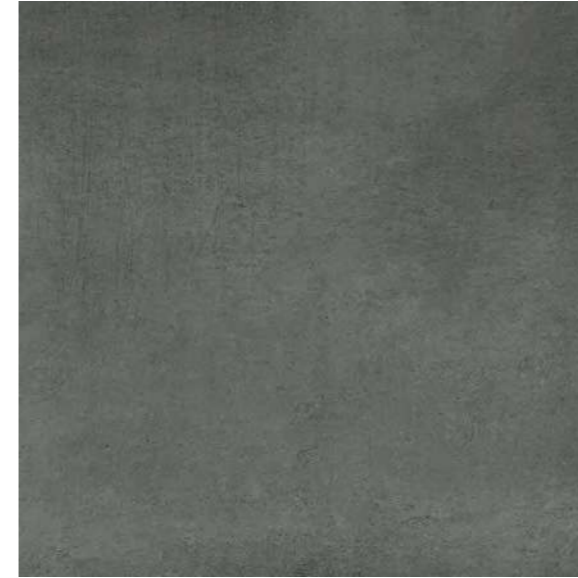

**606215**  
ARTWORK PIOMBO RETTIFICATO 60x60  
Cod. **79** □



**490663**  
ARTWORK PIOMBO RETTIFICATO 30x60  
Cod. **76** □



**106017**  
ARTWORK PIOMBO RETTIFICATO 10x60  
Cod. **83** □



**103122**  
ARTWORK PIOMBO RETTIFICATO 10x30  
Cod. **77** □



4  
7,50 kg

**380283**  
ARTWORK PIOMBO MULTILEVEL SU RETE 19,5x48,8  
Cod. **40** ○



**050228**  
ARTWORK PIOMBO RETTIFICATO 5x20  
Cod. **93** □

IMBALLI • PACKAGES • EMBALLAGES • FORMATE

	SCATOLA • BOX • BOITE • KARTON			PALLET • PALLETS • PALETTS • PALETTE		
	<i>pz</i>	<i>mq</i>	<i>kg</i>	<i>box</i>	<i>mq</i>	<i>kg</i>
<b>90x90</b>	2	1,62	35,95	20	32,40	745,00
<b>45x90</b>	3	1,22	25,20	32	39,04	830,00
<b>60x60</b>	3	1,08	21,20	40	43,20	875,00
<b>30x60</b>	6	1,08	21,00	40	43,20	865,00
<b>10x60</b>	12	0,72	15,40	60	43,20	950,00
<b>10x30</b>	20	0,60	14,00	60	36,00	850,00
<b>5x20</b>	56	0,56	14,00	60	33,60	850,00

	CASSA • CRATE • CAISSE • HOLZKISTE			CAVALLETTO • A-FRAME • CHEVALET • TRANSPORTGESTELL					
	<i>pz</i>	<i>mq</i>	<i>kg</i>	<i>pz</i>	<i>mq</i>	<i>kg</i>			
<b>120x280</b>	1	3,36	47,04	20	67,20	1.090,00	44	147,84	2.220,00



120286  
ARTWORK SABBIA RETTIFICATO 120x280  
Cod. 112 □

± 6 mm

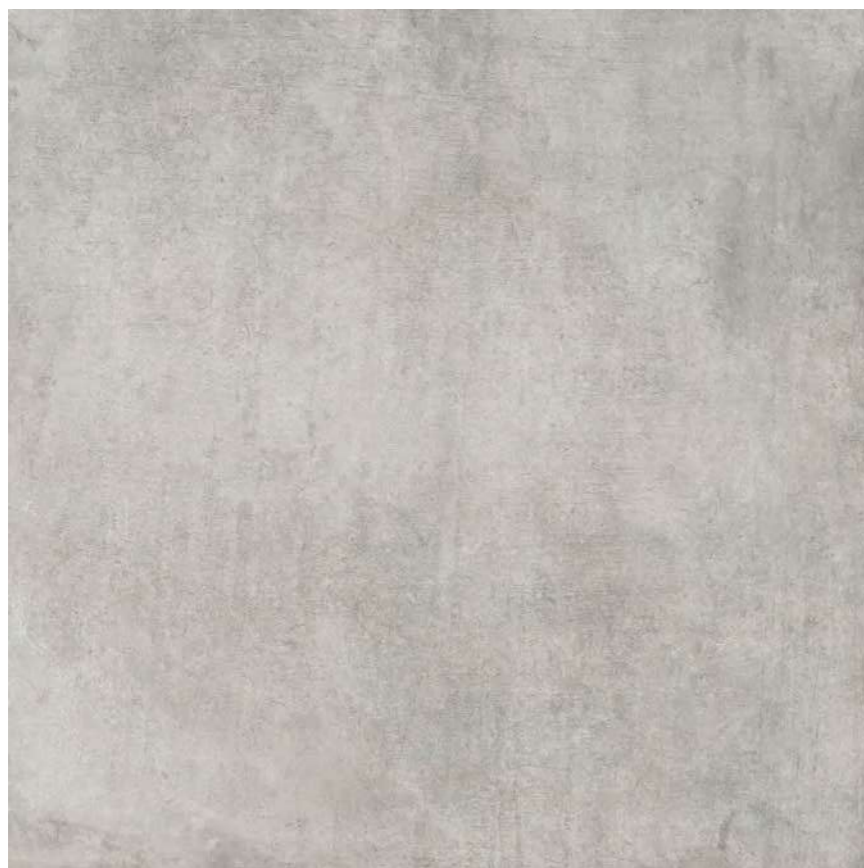

**909041**  
ARTWORK SABBIA RETTIFICATO 90x90  
Cod. **97** □

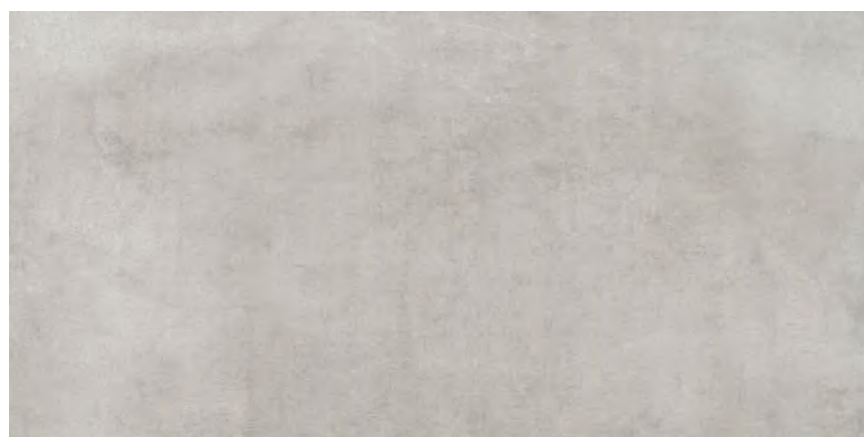

**459033**  
ARTWORK SABBIA RETTIFICATO 45x90  
Cod. **90** □



6  
12,30 kg

**041203**  
ARTWORK SABBIA MOSAICO 5x5  
SU RETE 30x30 Cod. **24** ○

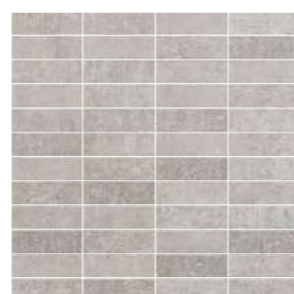

6  
12,30 kg

**501148**  
ARTWORK SABBIA FRAME 2,5x7,5  
SU RETE 30x30 Cod. **28** ○



**606216**  
ARTWORK SABBIA RETTIFICATO 60x60  
Cod. **79** □



**490664**  
ARTWORK SABBIA RETTIFICATO 30x60  
Cod. **76** □

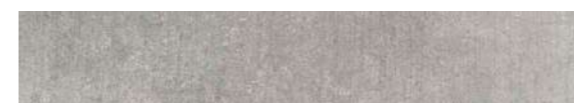

**106018**  
ARTWORK SABBIA RETTIFICATO 10x60  
Cod. **83** □



**103123**  
ARTWORK SABBIA RETTIFICATO 10x30  
Cod. **77** □



4  
7,50 kg

**380284**  
ARTWORK SABBIA MULTILEVEL  
SU RETE 19,5x48,8 Cod. **40** ○



**050229**  
ARTWORK SABBIA RETTIFICATO 5x20  
Cod. **93** □

IMBALLI • PACKAGES • EMBALLAGES • FORMATE

	SCATOLA • BOX • BOITE • KARTON			PALLET • PALLETS • PALETTS • PALETTE		
	pz	mq	kg	box	mq	kg
<b>90x90</b>	2	1,62	35,95	20	32,40	745,00
<b>45x90</b>	3	1,22	25,20	32	39,04	830,00
<b>60x60</b>	3	1,08	21,20	40	43,20	875,00
<b>30x60</b>	6	1,08	21,00	40	43,20	865,00
<b>10x60</b>	12	0,72	15,40	60	43,20	950,00
<b>10x30</b>	20	0,60	14,00	60	36,00	850,00
<b>5x20</b>	56	0,56	14,00	60	33,60	850,00

	CASSA • CRATE • CAISSE • HOLZKISTE			CAVALLETTO • A-FRAME • CHEVALET • TRANSPORTGESTELL					
	pz	mq	kg	pz	mq	kg			
<b>120x280</b>	1	3,36	47,04	20	67,20	1.090,00	44	147,84	2.220,00



120287  
ARTWORK TORTORA RETTIFICATO 120x280  
Cod. 112 □

± 6 mm



**909039**  
ARTWORK TORTORA RETTIFICATO 90x90  
Cod. **97** □



**459030**  
ARTWORK TORTORA RETTIFICATO 45x90  
Cod. **90** □

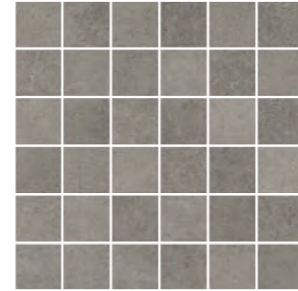

6  
12,30 kg

**041200**  
ARTWORK TORTORA MOSAICO 5x5  
SU RETE 30x30 Cod. **24** ○

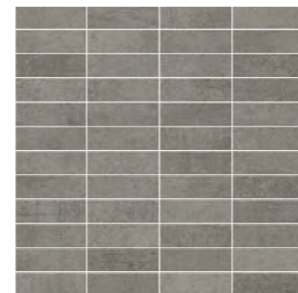

6  
12,30 kg

**501145**  
ARTWORK TORTORA FRAME 2,5x7,5  
SU RETE 30x30 Cod. **28** ○



**606213**  
ARTWORK TORTORA RETTIFICATO 60x60  
Cod. **79** □



**490661**  
ARTWORK TORTORA RETTIFICATO 30x60  
Cod. **76** □

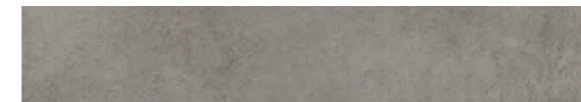

**106019**  
ARTWORK TORTORA RETTIFICATO 10x60  
Cod. **83** □



**103124**  
ARTWORK TORTORA RETTIFICATO 10x30  
Cod. **77** □

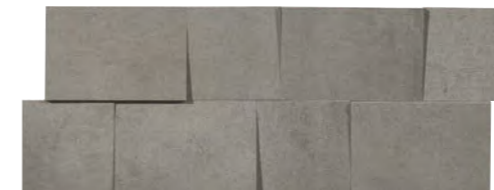

4  
7,50 kg

**380281**  
ARTWORK TORTORA MULTILEVEL SU RETE 19,5x48,8  
Cod. **40** ○



**050230**  
ARTWORK TORTORA RETTIFICATO 5x20  
Cod. **93** □

IMBALLI • PACKAGES • EMBALLAGES • FORMATE

	SCATOLA • BOX • BOITE • KARTON			PALLET • PALLETS • PALETTS • PALETTE		
	pz	mq	kg	box	mq	kg
<b>90x90</b>	2	1,62	35,95	20	32,40	745,00
<b>45x90</b>	3	1,22	25,20	32	39,04	830,00
<b>60x60</b>	3	1,08	21,20	40	43,20	875,00
<b>30x60</b>	6	1,08	21,00	40	43,20	865,00
<b>10x60</b>	12	0,72	15,40	60	43,20	950,00
<b>10x30</b>	20	0,60	14,00	60	36,00	850,00
<b>5x20</b>	56	0,56	14,00	60	33,60	850,00

	CASSA • CRATE • CAISSE • HOLZKISTE			CAVALLETTO • A-FRAME • CHEVALET • TRANSPORTGESTELL					
	pz	mq	kg	pz	mq	kg			
<b>120x280</b>	1	3,36	47,04	20	67,20	1.090,00	44	147,84	2.220,00

Pezzi speciali • Special trims • Pièces spéciales • Formstücke

Battiscopa		Angolare	
20 13,40 kg		14 15,68 kg	
	<b>290747</b> ARTWORK GRIGIO BATTISCOPA 5x60 Cod. <b>121</b> △		<b>490666</b> ARTWORK GRIGIO GRADINO 33x60 Cod. <b>112</b> ○
	<b>290748</b> ARTWORK PIOMBO BATTISCOPA 5x60 Cod. <b>121</b> △		<b>490670</b> ARTWORK GRIGIO ANGOLARE 33x60 Cod. <b>107</b> ○
	<b>290749</b> ARTWORK SABBIA BATTISCOPA 5x60 Cod. <b>121</b> △		<b>490671</b> ARTWORK PIOMBO ANGOLARE 33x60 Cod. <b>107</b> ○
	<b>290746</b> ARTWORK TORTORA BATTISCOPA 5x60 Cod. <b>121</b> △		<b>490672</b> ARTWORK SABBIA ANGOLARE 33x60 Cod. <b>107</b> ○
			<b>490673</b> ARTWORK TORTORA ANGOLARE 33x60 Cod. <b>107</b> ○
2 10,00 kg		2 10,40 kg	
	<b>490674</b> ARTWORK GRIGIO GRADINO 33x90 Cod. <b>114</b> ○		<b>490678</b> ARTWORK GRIGIO ANGOLARE 33x90 Cod. <b>110</b> ○
	<b>490675</b> ARTWORK PIOMBO GRADINO 33x90 Cod. <b>114</b> ○		<b>490679</b> ARTWORK PIOMBO ANGOLARE 33x90 Cod. <b>110</b> ○
	<b>490676</b> ARTWORK SABBIA GRADINO 33x90 Cod. <b>114</b> ○		<b>490680</b> ARTWORK SABBIA ANGOLARE 33x90 Cod. <b>110</b> ○
	<b>490673</b> ARTWORK TORTORA GRADINO 33x90 Cod. <b>114</b> ○		<b>490677</b> ARTWORK TORTORA ANGOLARE 33x90 Cod. <b>110</b> ○
2 13,50 kg		2 14,50 kg	

CARATTERISTICHE DI QUALITÀ Quality characteristics Caractéristiques de qualité Qualitätseigenschaften	NORMA Norm Norme Norme	REQUISITO NORMA Required standards Valeur prescrite selon la norme Normvorgabe	RISULTATO Result Résultat Ergebniss
Assorbimento d'acqua Water absorption of the body Absorption d'eau de support Wasseraufnahme des Scherbens	ISO 10545-3	≤ 0,5	Conforme Conformity Conforme Gemäss
Resistenza a flessione Breaking strenght Résistance à la flexion Biegefestigkeit	ISO 10545-4	≥ 35 N/mm <sup>2</sup>	Conforme Conformity Conforme Gemäss
Resistenza all'abrasione Abrasion resistance Résistance a l'abrasion Abriebbestaendigkeit	ISO 10545-7		PEI V
Resistenza al gelo Frost resistance Résistance au gel Frostbeständigkeit		Nessun campione deve presentare rotture o alterazioni apprezzabili alla superficie No samples must show ruptures or noticeable surface alteration Aucuns enchantions doit présenter ruptures ou altérations appréciables de la surface Keines der Muster sollte Risse oder sichtbare Fehler der Oberfläche zeigen	Conforme Conformity Conforme Gemäss
Resistenza all'attacco chimico Chemical resistance Résistance à l'attaque chimique Beständigkeit gegen chemikalien	ISO 10545-13		GA GLA
Resistenza agli sbalzi termici Thermal shock resistance Résistance aux écarts de température Temperaturwechselbeständigkeit	ISO 10545-5		Conforme Conformity Conforme Gemäss
Resistenza scivolosità Sliding resistance Résistance au glissement Rutschfestigkeit	DIN 51130 R		R10
Resistenza scivolosità Sliding resistance Résistance au glissement Rutschfestigkeit	DIN 51097 (A+B+C)		A+B
Coefficiente d'attrito dinamico Wet dynamic coefficient of friction Coefficient de friction dynamique Reibungskoeffizient Schlüpfriqkeit (in Bewegung)	Bot 3000 E	DCOF ≥ 0,42	> 0,42
Significativa variazione Significant variation Variation important Bedeutsam Abweichung			V3

V1 Aspetto uniforme Uniform appearance Aspect uniforme Einheitliches Aussehen	V2 Lieve variazione Slight variation Légère variation Geringe Abweichung	V3 Significativa variazione Significant variation Variation important Bedeutsam Abweichung	V4 Forte stonalizzazione Substantial variation Effet dénuancé très accentué Akzentuierte Variation
---	--	--	--

**PER UNA POSA OTTIMALE DEL PRODOTTO CONSIGLIAMO SEMPRE DI MESCOLARE ALMENO TRE SCATOLE DI MATERIALE.**

For the best product laying results, material from at least three boxes should be mixed.

Pour une pose excellente, nous recommandons toujours de mélanger le contenu d'au moins trois boîtes.

Für eine optimale Verlegung des Erzeugnisses empfehlen wir stets, mindestens drei Packungen Material anzumischen.





Tipologia  
Type  
Typologie  
Typ  
Gres porcellanato smaltato  
Glazed porcelain  
Grès cérame emaille  
Feinsteinzeug glasiert

Formati R10  
Sizes  
Formats  
Formate  
60x90  
40x60  
40x40  
20x40  
20x20  
10x30  
MIX BOX

Formati R11 A - B - C  
Sizes  
Formats  
Formate  
60x90  
MIX BOX

Spessore  
Thickness  
Épaisseur  
Stärke  
10 mm  
20 mm

Resistenza scivolosità  
Sliding resistance  
Resistance au glissement  
Rutschfestigkeit  
R10 / A+B  
R11 / A+B+C

Grado di variazione cromatica  
Degree of colour change  
Degré de variation chromatique  
Grad der Farbabweichung  
V3



**609016**  
ATELIER GREY  
RETTIFICATO 60x90  
Cod. **79** □

**609020**  
ATELIER GREY  
RETTIFICATO **R11** 60x90  
Cod. **80** □



**406066**  
ATELIER GREY  
RETTIFICATO 40x60  
Cod. **70** □



**609013**  
ATELIER IVORY  
RETTIFICATO 60x90  
Cod. **79** □

**609017**  
ATELIER IVORY  
RETTIFICATO **R11** 60x90  
Cod. **80** □



**406063**  
ATELIER IVORY  
RETTIFICATO 40x60  
Cod. **70** □



**404020**  
ATELIER GREY  
RETTIFICATO 40x40  
Cod. **71** □



**204015**  
ATELIER GREY  
RETTIFICATO 20x40  
Cod. **78** □



**130090**  
ATELIER GREY  
RETTIFICATO 20x20  
Cod. **96** □



**401469**  
ATELIER GREY  
MOSAICO 5x5 SU RETE 30x30  
Cod. **27** ○



9,12 kg

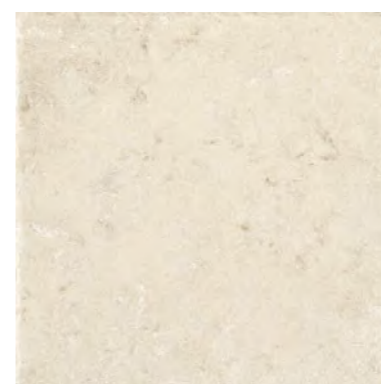

**404017**  
ATELIER IVORY  
RETTIFICATO 40x40  
Cod. **71** □



**204012**  
ATELIER IVORY  
RETTIFICATO 20x40  
Cod. **78** □

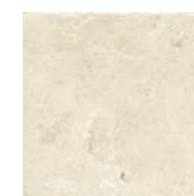

**130087**  
ATELIER IVORY  
RETTIFICATO 20x20  
Cod. **96** □



**401466**  
ATELIER IVORY  
MOSAICO 5x5 SU RETE 30x30  
Cod. **27** ○



9,12 kg



**753020**  
ATELIER GREY  
RETTIFICATO 7,5x30  
Cod. **81** □



**041478**  
ATELIER GREY  
MOSAICO ESAGONO SU RETE 34,7x30  
Cod. **43** ○



12,20 kg



**753017**  
ATELIER IVORY  
RETTIFICATO 7,5x30  
Cod. **81** □



**041475**  
ATELIER IVORY  
MOSAICO ESAGONO SU RETE 34,7x30  
Cod. **43** ○



12,20 kg

**IMBALLI • PACKAGES • EMBALLAGES • FORMATE**

	SCATOLA • BOX • BOITE • KARTON			PALLET • PALLETS • PALETTS • PALETTE		
	pz	m <sup>q</sup>	kg	box	m <sup>q</sup>	kg
<b>60x90</b>	2	1,08	21,70	48	51,84	1.040,00
<b>40x60</b>	4	0,96	19,20	48	46,08	922,00
<b>40x40</b>	6	0,96	19,20	60	57,60	1.152,00
<b>20x40</b>	8	0,64	13,68	72	46,08	922,00
<b>20x20</b>	16	0,64	13,68	72	46,08	922,00
<b>7,5x30</b>	32	0,72	15,00	68	48,96	1.000,00

**IMBALLI • PACKAGES • EMBALLAGES • FORMATE**

	SCATOLA • BOX • BOITE • KARTON			PALLET • PALLETS • PALETTS • PALETTE		
	pz	m <sup>q</sup>	kg	box	m <sup>q</sup>	kg
<b>60x90</b>	2	1,08	21,70	48	51,84	1.040,00
<b>40x60</b>	4	0,96	19,20	48	46,08	922,00
<b>40x40</b>	6	0,96	19,20	60	57,60	1.152,00
<b>20x40</b>	8	0,64	13,68	72	46,08	922,00
<b>20x20</b>	16	0,64	13,68	72	46,08	922,00
<b>7,5x30</b>	32	0,72	15,00	68	48,96	1.000,00



**609015**  
ATELIER WHITE  
RETTIFICATO 60x90  
Cod. **79** □

**609019**  
ATELIER WHITE  
RETTIFICATO **R11** 60x90  
Cod. **80** □



**406065**  
ATELIER WHITE  
RETTIFICATO 40x60  
Cod. **70** □



**609014**  
ATELIER BEIGE  
RETTIFICATO 60x90  
Cod. **79** □

**609018**  
ATELIER BEIGE  
RETTIFICATO **R11** 60x90  
Cod. **80** □



**406064**  
ATELIER BEIGE  
RETTIFICATO 40x60  
Cod. **70** □

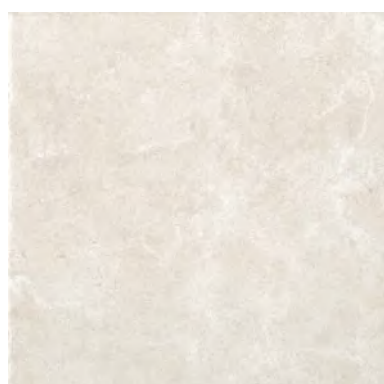

**404019**  
ATELIER WHITE  
RETTIFICATO 40x40  
Cod. **71** □

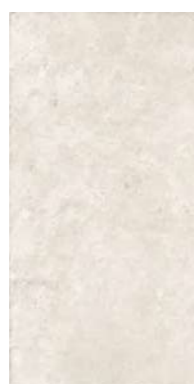

**204014**  
ATELIER WHITE  
RETTIFICATO 20x40  
Cod. **78** □

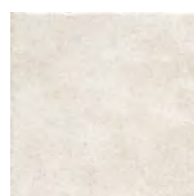

**130089**  
ATELIER WHITE  
RETTIFICATO 20x20  
Cod. **96** □



**041468**  
ATELIER WHITE  
MOSAICO 5x5 SU RETE 30x30  
Cod. **27** ○



9,12 kg



**404018**  
ATELIER BEIGE  
RETTIFICATO 40x40  
Cod. **71** □



**204013**  
ATELIER BEIGE  
RETTIFICATO 20x40  
Cod. **78** □



**130088**  
ATELIER BEIGE  
RETTIFICATO 20x20  
Cod. **96** □



**041467**  
ATELIER BEIGE  
MOSAICO 5x5 SU RETE 30x30  
Cod. **27** ○



9,12 kg



**753019**  
ATELIER WHITE  
RETTIFICATO 7,5x30  
Cod. **81** □



**041477**  
ATELIER WHITE  
MOSAICO ESAGONO SU RETE 34,7x30  
Cod. **43** ○



12,20 kg



**753018**  
ATELIER BEIGE  
RETTIFICATO 7,5x30  
Cod. **81** □

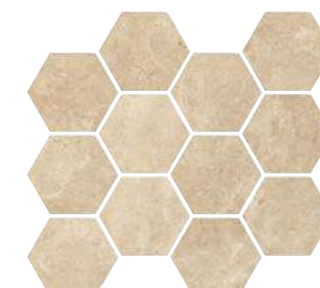

**041476**  
ATELIER BEIGE  
MOSAICO ESAGONO SU RETE 34,7x30  
Cod. **43** ○



12,20 kg

**IMBALLI • PACKAGES • EMBALLAGES • FORMATE**

	SCATOLA • BOX • BOITE • KARTON			PALLET • PALLETS • PALETTS • PALETTE		
	pz	m <sup>q</sup>	kg	box	m <sup>q</sup>	kg
<b>60x90</b>	2	1,08	21,70	48	51,84	1.040,00
<b>40x60</b>	4	0,96	19,20	48	46,08	922,00
<b>40x40</b>	6	0,96	19,20	60	57,60	1.152,00
<b>20x40</b>	8	0,64	13,68	72	46,08	922,00
<b>20x20</b>	16	0,64	13,68	72	46,08	922,00
<b>7,5x30</b>	32	0,72	15,00	68	48,96	1.000,00

**IMBALLI • PACKAGES • EMBALLAGES • FORMATE**

	SCATOLA • BOX • BOITE • KARTON			PALLET • PALLETS • PALETTS • PALETTE		
	pz	m <sup>q</sup>	kg	box	m <sup>q</sup>	kg
<b>60x90</b>	2	1,08	21,70	48	51,84	1.040,00
<b>40x60</b>	4	0,96	19,20	48	46,08	922,00
<b>40x40</b>	6	0,96	19,20	60	57,60	1.152,00
<b>20x40</b>	8	0,64	13,68	72	46,08	922,00
<b>20x20</b>	16	0,64	13,68	72	46,08	922,00
<b>7,5x30</b>	32	0,72	15,00	68	48,96	1.000,00



609024  
ATELIER GREY 2 CM 60x90 RETTIFICATO R11  
Cod. 141 □

± 20 mm



609021  
ATELIER IVORY 2 CM 60x90 RETTIFICATO R11  
Cod. 141 □

± 20 mm



609022  
ATELIER BEIGE 2 CM 60x90 RETTIFICATO R11  
Cod. 141 □

± 20 mm

IMBALLI • PACKAGES • EMBALLAGES • FORMATE

	SCATOLA • BOX • BOITE • KARTON			PALLET • PALLETS • PALETTS • PALETTE		
	<i>pz</i>	<i>mq</i>	<i>kg</i>	<i>box</i>	<i>mq</i>	<i>kg</i>
60x90 (20mm)	1	0,54	23,60	45	24,30	1.060,00



Suggerimenti di posa • Laying proposals • Solutions de pose • Verlegevorschläge

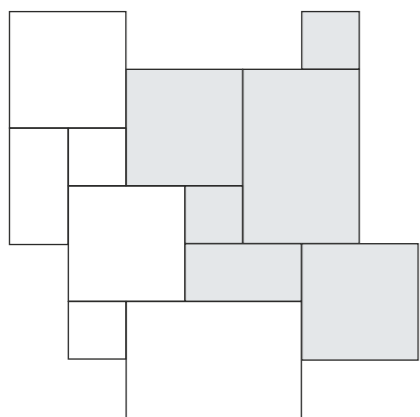

**609012**  
ATELIER GREY RETTIFICATO  
MIX BOX 40x60 - 40x40 - 20x40 - 20x20  
Cod. **120** □

**609038**  
ATELIER GREY RETTIFICATO **R11**  
MIX BOX 40x60 - 40x40 - 20x40 - 20x20  
Cod. **79** □

**609009**  
ATELIER IVORY RETTIFICATO  
MIX BOX 40x60 - 40x40 - 20x40 - 20x20  
Cod. **120** □

**609030**  
ATELIER IVORY RETTIFICATO **R11**  
MIX BOX 40x60 - 40x40 - 20x40 - 20x20  
Cod. **79** □

**609011**  
ATELIER WHITE RETTIFICATO  
MIX BOX 40x60 - 40x40 - 20x40 - 20x20  
Cod. **120** □

**609037**  
ATELIER WHITE RETTIFICATO **R11**  
MIX BOX 40x60 - 40x40 - 20x40 - 20x20  
Cod. **79** □

**609010**  
ATELIER BEIGE RETTIFICATO  
MIX BOX 40x60 - 40x40 - 20x40 - 20x20  
Cod. **120** □

**609031**  
ATELIER BEIGE RETTIFICATO **R11**  
MIX BOX 40x60 - 40x40 - 20x40 - 20x20  
Cod. **79** □

IMBALLI • PACKAGES • EMBALLAGES • FORMATE

	SCATOLA • BOX • BOITE • KARTON			PALLET • PALLETS • PALETTS • PALETTE		
	pz	mq	kg	box	mq	kg
<b>MIX BOX</b>	6	0,72	15,30	40	28,80	613,00

Suggerimenti di posa • Laying proposals • Solutions de pose • Verlegevorschläge

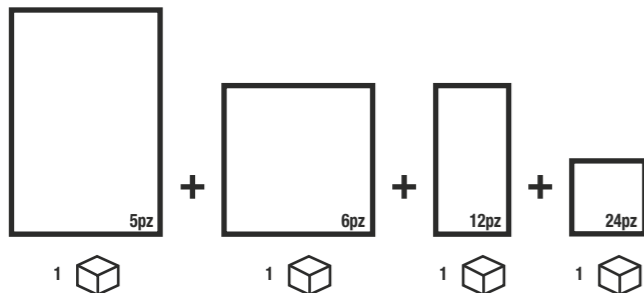

**600173**  
ATELIER GREY RETTIFICATO  
COMPO  
40x60 - 40x40 - 20x40 - 20x20  
Cod. **117** □

**600170**  
ATELIER IVORY RETTIFICATO  
COMPO  
40x60 - 40x40 - 20x40 - 20x20  
Cod. **117** □

40 x 60 .....33,46 %  
40 x 40 .....44,47 %

**600172**  
ATELIER WHITE RETTIFICATO  
COMPO  
40x60 - 40x40 - 20x40 - 20x20  
Cod. **117** □

**600171**  
ATELIER BEIGE RETTIFICATO  
COMPO  
40x60 - 40x40 - 20x40 - 20x20  
Cod. **117** □

20 x 40 .....11,06 %  
20 x 20 .....11,01 %

Pezzi speciali • Special trims • Pièces spéciales • Formstücke

Battiscopa 10,90 kg

10,90 kg

**290870**  
ATELIER GREY RETTIFICATO  
BATTISCOPA 5x30  
Cod. **116** △

**290867**  
ATELIER IVORY RETTIFICATO  
BATTISCOPA 5x30  
Cod. **116** △

**290869**  
ATELIER WHITE RETTIFICATO  
BATTISCOPA 5x30  
Cod. **116** △

**290868**  
ATELIER BEIGE RETTIFICATO  
BATTISCOPA 5x30  
Cod. **116** △

**290874**  
ATELIER GREY RETTIFICATO  
BATTISCOPA 5x60  
Cod. **121** △

**290871**  
ATELIER IVORY RETTIFICATO  
BATTISCOPA 5x60  
Cod. **121** △

**290873**  
ATELIER WHITE RETTIFICATO  
BATTISCOPA 5x60  
Cod. **121** △

**290872**  
ATELIER BEIGE RETTIFICATO  
BATTISCOPA 5x60  
Cod. **121** △

CARATTERISTICHE DI QUALITÀ Quality characteristics Caractéristiques de qualité Qualitätseigenschaften	NORMA Norm Norme Norme	REQUISITO NORMA Required standards Valeur prescrite selon la norme Normvorgabe	RISULTATO Result Résultat Ergebniss
Assorbimento d'acqua Water absorption of the body Absorption d'eau de support Wasseraufnahme des Scherbens	ISO 10545-3	≤ 0,5	Conforme Conformity Conforme Gemäss
Resistenza a flessione Breaking strength Résistance à la flexion Biegefestigkeit	ISO 10545-4	≥ 35 N/mm <sup>2</sup>	Conforme Conformity Conforme Gemäss
Resistenza all'abrasione Abrasion resistance Resistance a l'abrasion Abriebbeständigkeit	EN ISO 10545-7		PEI V
Resistenza al gelo Frost resistance Résistance au gel Frostbeständigkeit	ISO 10545-12	Nessun campione deve presentare rotture o alterazioni apprezzabili alla superficie No samples must show ruptures or noticeable surface alteration Aucuns enchantions doit présenter ruptures ou altérations appréciables de la surface Keines der Muster sollte Risse oder sichtbare Fehler der Oberfläche zeigen	Conforme Conformity Conforme Gemäss
Resistenza all'attacco chimico Chemical resistance Résistance à l'attaque chimique Beständigkeit gegen chemikalien	ISO 10545-13		GA GLA
Resistenza agli sbalzi termici Thermal shock resistance Resistance aux écarts de température Temperaturwechselbeständigkeit	ISO 10545-5		Conforme Conformity Conforme Gemäss
Resistenza scivolosità Sliding resistance Resistance au glissement Rutschfestigkeit	DIN 51130 R	Atelier Atelier R11 - Atelier 20 mm	R10 R11
Resistenza scivolosità Sliding resistance Resistance au glissement Rutschfestigkeit	DIN 51097 (A+B+C)	Atelier Atelier R11 - Atelier 20 mm	A+B A+B+C
Coefficiente d'attrito dinamico Wet dynamic coefficient of friction Coefficient de friction dynamique Reibungskoeffizient Schlipfgrigkeit (in Bewegung)	Bot 3000 E	DCOF ≥ 0,42	> 0,42
Significativa variazione Significant variation Variation important Bedeutsam Abweichung			V3

**V1** Aspetto uniforme  
Uniform appearance  
Aspect uniforme  
Einheitliches Aussehen

**V2** Lieve variazione  
Slight variation  
Légère variation  
Geringe Abweichung

**V3** Significativa variazione  
Significant variation  
Variation important  
Bedeutsam Abweichung

**V4** Forte stonizzazione  
Substantial variation  
Effet dénuancé très accentué  
Akzentuierte Variation

**PER UNA POSA OTTIMALE DEL PRODOTTO CONSIGLIAMO SEMPRE DI MESCOLORE ALMENO TRE SCATOLE DI MATERIALE.**  
For the best product laying results, material from at least three boxes should be mixed.  
Pour une pose excellente, nous recommandons toujours de mélanger le contenu d'au moins trois boîtes.  
Für eine optimale Verlegung des Erzeugnisses empfehlen wir stets, mindestens drei Packungen Material anzumischen.



Tipologia  
Type  
Typologie  
Typ  
Gres porcellanato smaltato  
Glazed porcelain  
Grès cérame emaille  
Feinsteinzeug glasiert

Formati  
Sizes  
Formats  
Formate  
60x120  
60x60  
30x60  
30x30  
10x30  
15x17 Esagona

Spessore  
Thickness  
Épaisseur  
Stärke  
9 mm

Resistenza scivolosità  
Sliding resistance  
Resistance au glissement  
Rutschfestigkeit  
R9

Grado di variazione cromatica  
Degree of colour change  
Degré de variation chromatique  
Grad der Farbabweichung  
V3



**601292**  
ATLANTIC BLUE NATURALE  
RETTIFICATO 60x120  
Cod. **94** □

**601293**  
ATLANTIC BLUE LAPPATO  
RETTIFICATO 60x120  
Cod. **103** □



**606247**  
ATLANTIC BLUE NATURALE  
RETTIFICATO 60x60  
Cod. **79** □

**606248**  
ATLANTIC BLUE LAPPATO  
RETTIFICATO 60x60  
Cod. **93** □

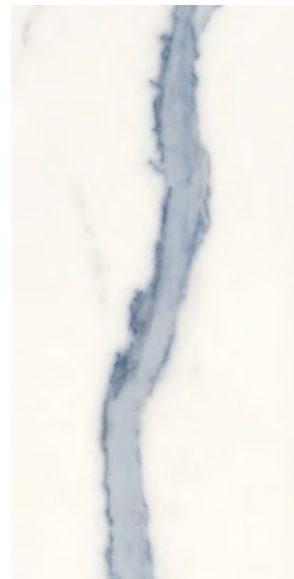

**490760**  
ATLANTIC BLUE NATURALE  
RETTIFICATO 30x60  
Cod. **76** □

**490761**  
ATLANTIC BLUE LAPPATO  
RETTIFICATO 30x60  
Cod. **85** □



**041333**  
ATLANTIC BLUE NATURALE  
RETTIFICATO 30x30  
Cod. **78** □

**041334**  
ATLANTIC BLUE LAPPATO  
RETTIFICATO 30x30  
Cod. **90** □



**103135**  
ATLANTIC BLUE NATURALE  
RETTIFICATO 10x30  
Cod. **77** □

**103136**  
ATLANTIC BLUE LAPPATO  
RETTIFICATO 10x30  
Cod. **93** □



**041349**  
ATLANTIC BLUE NATURALE  
MOSAICO 5x5 SU RETE 30x30  
Cod. **24** ○

**041350**  
ATLANTIC BLUE LAPPATO  
MOSAICO 5x5 SU RETE 30x30  
Cod. **31** ○

6  
9,30 kg



**041357**  
ATLANTIC BLUE NATURALE  
MOSAICO ESAGONO SU RETE 27x28  
Cod. **136** ○

**041358**  
ATLANTIC BLUE LAPPATO  
MOSAICO ESAGONO SU RETE 27x28  
Cod. **49** ○

6  
8,90 kg



**041341**  
ATLANTIC BLUE NATURALE  
MOSAICO HB SU RETE 28x32  
Cod. **45** ○

**041342**  
ATLANTIC BLUE LAPPATO  
MOSAICO HB SU RETE 28x32  
Cod. **48** ○

6  
10,20 kg



**041326**  
ATLANTIC BLUE NATURALE  
MOSAICO TIMELESS SU RETE 30x30  
Cod. **68** ○

**041325**  
ATLANTIC BLUE LAPPATO  
MOSAICO TIMELESS SU RETE 30x30  
Cod. **75** ○

6  
9,70 kg



**041318**  
ATLANTIC BLUE NATURALE  
MOSAICO ARABESQUE SU RETE 30x30  
Cod. **57** ○

**041317**  
ATLANTIC BLUE LAPPATO  
MOSAICO ARABESQUE SU RETE 30x30  
Cod. **72** ○

6  
9,70 kg



**230301**  
ATLANTIC BLUE NATURALE  
ESAGONA 15x17  
Cod. **137** □

**230302**  
ATLANTIC BLUE LAPPATO  
ESAGONA 15x17  
Cod. **113** □



**380307**  
ATLANTIC BLUE NATURALE  
BORDURA MURETTO 7x30  
Cod. **28** ○

**380306**  
ATLANTIC BLUE LAPPATO  
BORDURA MURETTO 7x30  
Cod. **28** ○

10  
3,60 kg



**380314**  
ATLANTIC BLUE NATURALE  
LONDON 5x30  
Cod. **33** ○

**380315**  
ATLANTIC BLUE LUCIDO  
LONDON 5x30  
Cod. **33** ○

24  
6,44 kg

IMBALLI • PACKAGES • EMBALLAGES • FORMATE

	SCATOLA • BOX • BOITE • KARTON			PALLET • PALLETS • PALETTS • PALETTE		
	pz	mq	kg	box	mq	kg
<b>60x120</b>	2	1,44	30,20	30	43,20	906,00
<b>60x60</b>	3	1,08	22,60	40	43,20	904,00
<b>30x60</b>	6	1,08	22,60	40	43,20	904,00
<b>30x30</b>	11	0,99	21,20	46	45,54	975,00
<b>10x30</b>	20	0,60	12,90	60	36,00	774,00
<b>15x17 Esagona</b>	30	0,57	11,00	56	31,92	616,00



## atlantic blue RETT. LAPPATO

La finitura lappata è consigliata per uso rivestimento o per pavimenti da bagno in ambito residenziale. Nello specifico il tipo di pavimentazione deve essere non soggetta ad eccessive sollecitazioni e mai a diretto contatto con aree esterne. Come si verifica comunemente nelle pietre naturali l'eventuale presenza di puntini sulla superficie o di qualche disuniformità della lucentezza sono da considerare caratteristiche del prodotto derivanti dalla lavorazione a cui viene sottoposto.

The polished finish is recommended for wall coverings or for the floors of residential bathrooms. Specifically, floor coverings in this material must not be subjected to excessively heavy traffic and must never be in direct contact with outdoor areas. As is often the case with natural stones, any spots on the surface or any unevenness in shine are typical characteristics of the product, deriving from the process used.

La finitura lappata est recommandée pour le revêtement sol et mur des salles de bains résidentielles. Notamment, ce type de carreau au sol ne doit pas être exposé à des contraintes excessives, et il ne doit jamais être en contact direct avec des zones extérieures. Comme cela est souvent le cas pour les pierres naturelles, les micro trous éventuellement présents à la surface du produit ou l'hétérogénéité de son éclat forment des caractéristiques propres au façonnage.

Die polierte Oberfläche wird für Wandverkleidungen und Bodenbeläge in Privatbädern empfohlen. Der Bodenbelag darf keinen starken Beanspruchungen ausgesetzt sein und keinen direkten Kontakt zu Außenbereichen haben. Wie bei Natursteinen üblich, kann die Oberfläche Körnungen oder einen unregelmäßigen Glanz aufweisen. Diese Merkmale sind typische, beabsichtigte Produkteigenschaften, die durch das Bearbeitungsverfahren hervorgerufen werden.

Pezzi speciali • Special trims • Pièces spéciales • Formstücke

Battiscopa	44 22,40 kg	18 17,10 kg
	<b>290795</b> ATLANTIC BLUE NATURALE BATTISCOPA 7x30 Cod. <b>116</b> △	<b>290805</b> ATLANTIC BLUE NATURALE BATTISCOPA 7x60 Cod. <b>121</b> △
	<b>290798</b> ATLANTIC BLUE LAPPATO BATTISCOPA 7x30 Cod. <b>22</b> △	<b>290806</b> ATLANTIC BLUE LAPPATO BATTISCOPA 7x60 Cod. <b>26</b> △

CARATTERISTICHE DI QUALITÀ Quality characteristics Caractéristiques de qualité Qualitätseigenschaften	NORMA Norm Norme Norme	REQUISITO NORMA Required standards Valeur prescrite selon la norme Normvorgabe	RISULTATO Result Résultat Ergebniss
Assorbimento d'acqua Water absorption of the body Absorption d'eau de support Wasseraufnahme des Scherbens	ISO 10545-3	≤ 0,5	Conforme Conformity Conforme Gemäss
Resistenza a flessione Breaking strenght Résistance à la flexion Biegefestigkeit	ISO 10545-4	≥ 35 N/mm <sup>2</sup>	Conforme Conformity Conforme Gemäss
Resistenza all'abrasione Abrasion resistance Résistance à l'abrasion Abriebbeständigkeit	ISO 10545-7	ATLANTIC BLUE Rettificato	PEI IV
Resistenza al gelo Frost resistance Résistance au gel Frostbeständigkeit	ISO 10545-12	Nessun campione deve presentare rotture o alterazioni apprezzabili alla superficie No samples must show ruptures or noticeable surface alteration Aucuns enchantions doit présenter ruptures ou altérations appréciables de la surface Keines der Muster sollte Risse oder sichtbare Fehler der Oberfläche zeigen	Conforme Conformity Conforme Gemäss
Resistenza all'attacco chimico Chemical resistance Résistance à l'attaque chimique Beständigkeit gegen chemikalien	ISO 10545-13	ATLANTIC BLUE Naturale ATLANTIC BLUE Lappato	GA GLA GA GLB
Resistenza agli sbalzi termici Thermal shock resistance Résistance aux écarts de température Temperaturwechselbeständigkeit	ISO 10545-5		Conforme Conformity Conforme Gemäss
Resistenza scivolosità Sliding resistance Résistance au glissement Rutschfestigkeit	DIN 51130 R		R9
Significativa variazione Significant variation Variation important Bedeutsam Abweichung		ATLANTIC BLUE Rettificato	V3

<b>V1</b> Aspetto uniforme Uniform appearance Aspect uniforme Einheitliches Aussehen	<b>V2</b> Lieve variazione Slight variation Légère variation Geringe Abweichung	<b>V3</b> Significativa variazione Significant variation Variation important Bedeutsam Abweichung	<b>V4</b> Forte stonalizzazione Substantial variation Effet dénuancé très accentué Akzentuierte Variation
--	---	---	---

**PER UNA POSA OTTIMALE DEL PRODOTTO CONSIGLIAMO SEMPRE DI MESCOLARE ALMENO TRE SCATOLE DI MATERIALE.**

For the best product laying results, material from at least three boxes should be mixed.

Pour une pose excellente, nous recommandons toujours de mélanger le contenu d'au moins trois boîtes.

Für eine optimale Verlegung des Erzeugnisses empfehlen wir stets, mindestens drei Packungen Material anzumischen.





Tipologia  
Type  
Typologie  
Typ  
Gres porcellanato smaltato  
Glazed porcelain  
Grès cérame emaille  
Feinsteinzeug glasiert

Formati  
Sizes  
Formats  
Formate  
60x120  
60x60  
30x60  
10x30

Spessore  
Thickness  
Épaisseur  
Stärke  
9 mm

Resistenza scivolosità  
Sliding resistance  
Resistance au glissement  
Rutschfestigkeit  
R9

Grado di variazione cromatica  
Degree of colour change  
Degré de variation chromatique  
Grad der Farbabweichung  
V3

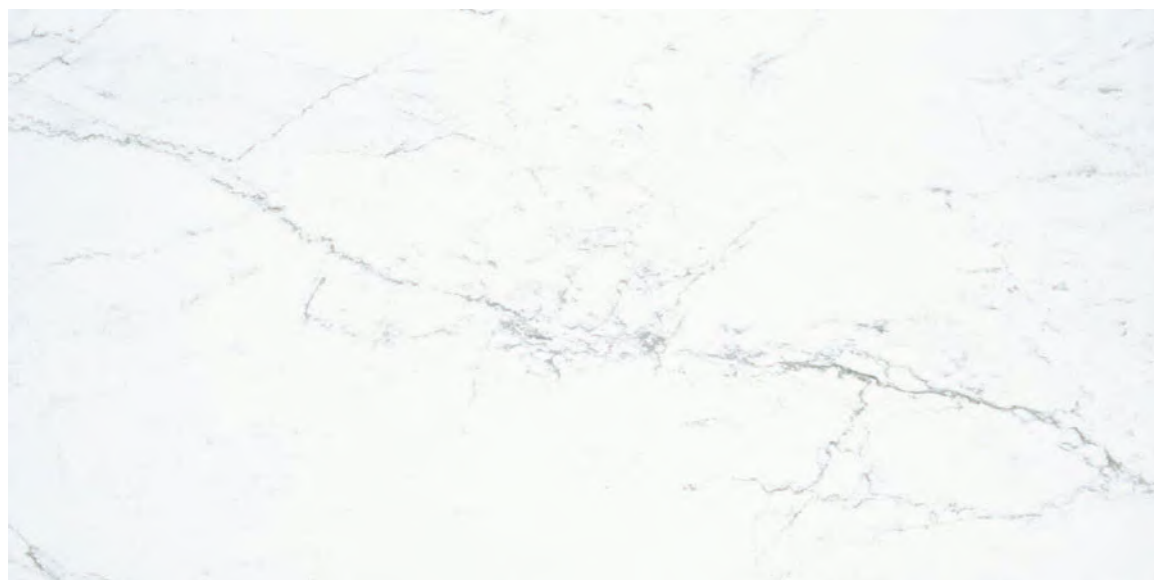

**601324**  
AVENUE WHITE  
RETTIFICATO 60x120  
Cod. **94** □



**606270**  
AVENUE WHITE  
RETTIFICATO 60x60  
Cod. **87** □



**490821**  
AVENUE WHITE  
RETTIFICATO 30x60  
Cod. **79** □



**103151**  
AVENUE WHITE  
RETTIFICATO 10x30  
Cod. **87** □



6  
9,70 kg

**041423**  
AVENUE WHITE  
MOSAICO 5x5 SU RETE 30x30  
Cod. **26** ○



6  
8,90kg

**041431**  
AVENUE WHITE  
ESAGONO SU RETE 27x28  
Cod. **45** ○

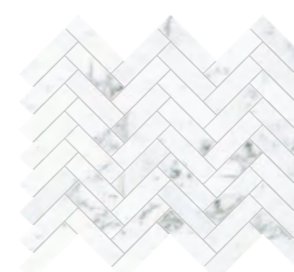

6  
9,80 kg

**041439**  
AVENUE WHITE  
MOSAICO HB SU RETE 28x32  
Cod. **46** ○



6  
9,80 kg

**041448**  
AVENUE WHITE  
MOSAICO ANTIQUE LUX SU RETE 30x30  
Cod. **69** ○

IMBALLI • PACKAGES • EMBALLAGES • FORMATE

	SCATOLA • BOX • BOITE • KARTON			PALLET • PALLETS • PALETTS • PALETTE		
	<i>pz</i>	<i>mq</i>	<i>kg</i>	<i>box</i>	<i>mq</i>	<i>kg</i>
<b>60x120</b>	2	1,44	28,70	30	43,20	861,00
<b>60x60</b>	3	1,08	21,50	40	43,20	861,00
<b>30x60</b>	6	1,08	21,50	40	43,20	861,00
<b>10x30</b>	20	0,60	11,40	60	36,00	684,00



Pezzi speciali • Special trims • Pièces spéciales • Formstücke

Battiscopa



17,20 kg



14,80 kg

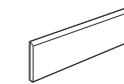

**0290839**  
AVENUE WHITE  
BATTISCOPA 7x30  
Cod. **19** △

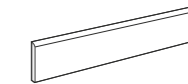

**0290847**  
AVENUE WHITE  
BATTISCOPA 7x60  
Cod. **23** △

CARATTERISTICHE DI QUALITÀ Quality characteristics Caractéristiques de qualité Qualitätseigenschaften	NORMA Norm Norme Norme	REQUISITO NORMA Required standards Valeur prescrite selon la norme Normvorgabe	RISULTATO Result Résultat Ergebniss
Assorbimento d'acqua Water absorption of the body Absorption d'eau de support Wasseraufnahme des Scherbens	ISO 10545-3	≤ 0,5	Conforme Conformity Conforme Gemäss
Resistenza a flessione Breaking strenght Résistance à la flexion Biegefestigkeit	ISO 10545-4	≥ 35 N/mm <sup>2</sup>	Conforme Conformity Conforme Gemäss
Resistenza all'abrasione Abrasion resistance Resistance a l'abrasion Abriebbeständigkeit	ISO 10545-7		PEI IV
Resistenza al gelo Frost resistance Résistance au gel Frostbeständigkeit	ISO 10545-12	Nessun campione deve presentare rotture o alterazioni apprezzabili alla superficie No samples must show ruptures or noticeable surface alteration Aucuns enchantions doit présenter ruptures ou altérations appréciables de la surface Keines der Muster sollte Risse oder sichtbare Fehler der Oberfläche zeigen	Conforme Conformity Conforme Gemäss
Resistenza all'attacco chimico Chemical resistance Résistance à l'attaque chimique Beständigkeit gegen chemikalien	ISO 10545-13		GA GLA
Resistenza agli sbalzi termici Thermal shock resistance Resistance aux écarts de température Temperaturwechselbeständigkeit	ISO 10545-5		Conforme Conformity Conforme Gemäss
Resistenza scivolosità Sliding resistance Resistance au glissement Rutschfestigkeit	DIN 51130 R		R9
Coefficiente d'attrito dinamico Wet dynamic coefficient of friction Coefficient de friction dynamique Reibungskoeffizient Schlupfrigkeit (in Bewegung)	Bot 3000 E	DCOF ≥ 0,42	> 0,42
Significativa variazione Significant variation Variation important Bedeutsam Abweichung			V3

**V1**  
Aspetto uniforme  
Uniform appearance  
Aspect uniforme  
Einheitliches Aussehen

**V2**  
Lieve variazione  
Slight variation  
Légère variation  
Geringe Abweichung

**V3**  
Significativa variazione  
Significant variation  
Variation important  
Bedeutsam Abweichung

**V4**  
Forte stonalizzazione  
Substantial variation  
Effet dénuancé très accentué  
Akzentuierte Variation

**PER UNA POSA OTTIMALE DEL PRODOTTO CONSIGLIAMO SEMPRE DI MESCOLARE ALMENO TRE SCATOLE DI MATERIALE.**

For the best product laying results, material from at least three boxes should be mixed.

Pour une pose excellente, nous recommandons toujours de mélanger le contenu d'au moins trois boîtes.

Für eine optimale Verlegung des Erzeugnisses empfehlen wir stets, mindestens drei Packungen Material anzumischen.



Tipologia  
Type  
Typologie  
Typ  
Gres porcellanato smaltato  
Glazed porcelain  
Grès cérame emaille  
Feinsteinzeug glasiert

Formati R10  
Sizes  
Formats  
Formate  
60x90  
40x60  
40x40  
20x40  
20x20  
7,5x30  
MIX BOX

Spessore  
Thickness  
Épaisseur  
Stärke  
10 mm

Resistenza scivolosità  
Sliding resistance  
Resistance au glissement  
Rutschfestigkeit  
R10 / A+B

Grado di variazione cromatica  
Degree of colour change  
Degré de variation chromatique  
Grad der Farbabweichung  
V2

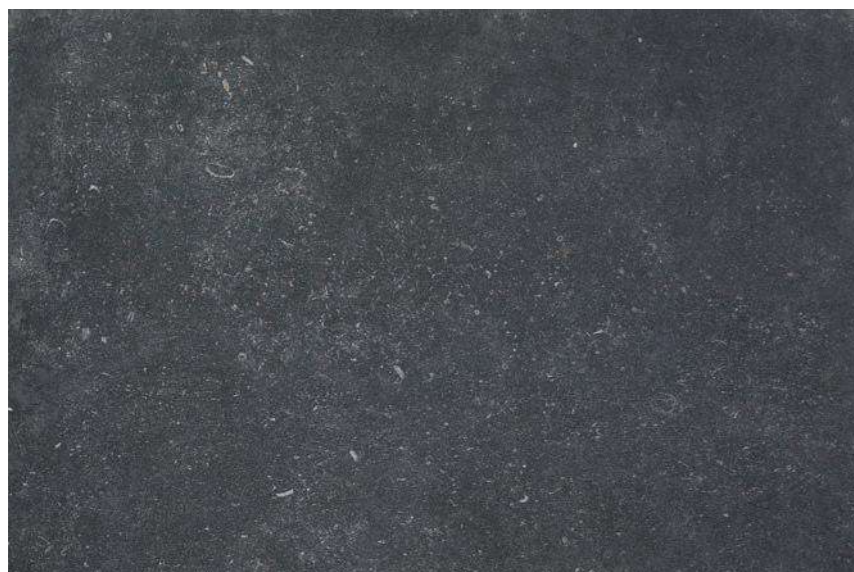

**609029**  
BLAUWSTEEN  
RETTIFICATO 60x90  
Cod. **79** □



**406067**  
BLAUWSTEEN  
RETTIFICATO 40x60  
Cod. **70** □



**404021**  
BLAUWSTEEN  
RETTIFICATO 40x40  
Cod. **71** □



**204016**  
BLAUWSTEEN  
RETTIFICATO 20x40  
Cod. **78** □



**130091**  
BLAUWSTEEN  
RETTIFICATO 20x20  
Cod. **96** □



6  
9,12 kg

**041604**  
BLAUWSTEEN  
MOSAICO 5x5 SU RETE 30x30  
Cod. **27** ○



**753021**  
BLAUWSTEEN  
RETTIFICATO 7,5x30  
Cod. **81** □



6  
12,20 kg

**041603**  
BLAUWSTEEN  
MOSAICO ESAGONO SU RETE 34,7x30  
Cod. **43** ○

**IMBALLI • PACKAGES • EMBALLAGES • FORMATE**

	SCATOLA • BOX • BOITE • KARTON			PALLET • PALLETS • PALETTS • PALETTE		
	pz	m <sup>q</sup>	kg	box	m <sup>q</sup>	kg
<b>60x90</b>	2	1,08	21,70	48	51,84	1.040,00
<b>40x60</b>	4	0,96	19,20	48	46,08	922,00
<b>40x40</b>	6	0,96	19,20	60	57,60	1.152,00
<b>20x40</b>	8	0,64	13,68	72	46,08	922,00
<b>20x20</b>	16	0,64	13,68	72	46,08	922,00
<b>7,5x30</b>	32	0,72	15,00	68	48,96	1.020,00



Suggerimenti di posa • Laying proposals • Solutions de pose • Verlegevorschläge

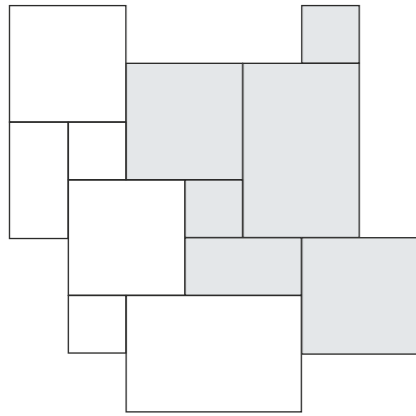

**609032**  
BLAUWSTEEN RETTIFICATO  
MIX BOX  
40x60 - 40x40 - 20x40 - 20x20  
Cod. **120** □

IMBALLI • PACKAGES • EMBALLAGES • FORMATE

	SCATOLA • BOX • BOITE • KARTON			PALLET • PALLETS • PALETTS • PALETTE		
	pz	mq	kg	box	mq	kg
<b>MIX BOX</b>	6	0,75	15,30	40	28,80	613,00

Suggerimenti di posa • Laying proposals • Solutions de pose • Verlegevorschläge

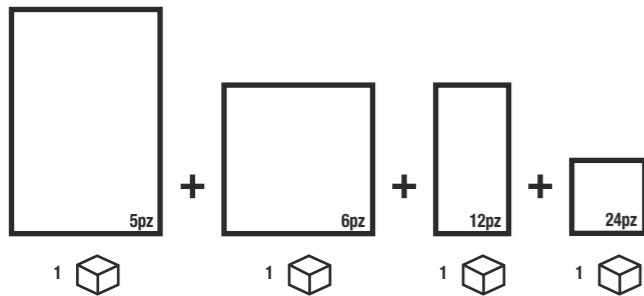

**600174**  
BLAUWSTEEN RETTIFICATO  
COMPO  
40x60 - 40x40 - 20x40 - 20x20  
Cod. **117** □

40 x 60.....	33,46 %	20 x 40.....	11,06 %
40 x 40.....	44,47 %	20 x 20.....	11,01 %









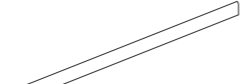

Pezzi speciali • Special trims • Pièces spéciales • Formstücke

Battiscopa  10,90 kg

 10,90 kg

 **290915**  
BLAUWSTEEN  
RETTIFICATO BATTISCOPA 5x30  
Cod. **116** △

 **290916**  
BLAUWSTEEN  
RETTIFICATO BATTISCOPA 5x60  
Cod. **121** △

CARATTERISTICHE DI QUALITÀ Quality characteristics Caractéristiques de qualité Qualitätseigenschaften	NORMA Norm Norme Norme	REQUISITO NORMA Required standards Valeur prescrite selon la norme Normvorgabe	RISULTATO Result Résultat Ergebniss
 Assorbimento d'acqua Water absorption of the body Absorption d'eau de support Wasseraufnahme des Scherbens	ISO 10545-3	≤ 0,5	Conforme Conformity Conforme Gemäss
 Resistenza a flessione Breaking strenght Résistance à la flexion Biegefestigkeit	ISO 10545-4	≥ 35 N/mm <sup>2</sup>	Conforme Conformity Conforme Gemäss
 Resistenza all'abrasione Abrasion resistance Résistance a l'abrasion Abriebbeständigkeit	EN ISO 10545-7		PEI IV
 Resistenza al gelo Frost resistance Résistance au gel Frostbeständigkeit	ISO 10545-12	Nessun campione deve presentare rotture o alterazioni apprezzabili alla superficie No samples must show ruptures or noticeable surface alteration Aucuns enchantions doit présenter ruptures ou altérations appréciables de la surface Keines der Muster sollte Risse oder sichtbare Fehler der Oberflaeche zeigen	Conforme Conformity Conforme Gemäss
 Resistenza all'attacco chimico Chemical resistance Résistance à l'attaque chimique Beständigkeit gegen chemikalien	ISO 10545-13		GA GLA
 Resistenza agli sbalzi termici Thermal shock resistance Resistance aux ecarts de température Temperaturwechselbeständigkeit	ISO 10545-5		Conforme Conformity Conforme Gemäss
 Resistenza scivolosità Sliding resistance Resistance au glissement Rutschfestigkeit	DIN 51130 R		R10
 Resistenza scivolosità Sliding resistance Resistance au glissement Rutschfestigkeit	DIN 51097 (A+B+C)		A+B
 Coefficiente d'attrito dinamico Wet dynamic coefficient of friction Coefficient de friction dynamique Reibungskoeffizient Schlüpfriqkeit (in Bewegung)	Bot 3000 E	DCOF ≥ 0,42	> 0,42
 Significativa variazione Significant variation Variation important Bedeutsam Abweichung			V2

 V1  
Aspetto uniforme  
Uniform appearance  
Aspect uniforme  
Einheitliches Aussehen

 V2  
Lieve variazione  
Slight variation  
Légère variation  
Geringe Abweichung

 V3  
Significativa variazione  
Significant variation  
Variation important  
Bedeutsam Abweichung

 V4  
Forte stonizzazione  
Substantial variation  
Effet dénuancé très accentué  
Akzentuierte Variation

**PER UNA POSA OTTIMALE DEL PRODOTTO CONSIGLIAMO SEMPRE DI MESCOLARE ALMENO TRE SCATOLE DI MATERIALE.**

For the best product laying results, material from at least three boxes should be mixed.

Pour une pose excellente, nous recommandons toujours de mélanger le contenu d'au moins trois boîtes.

Für eine optimale Verlegung des Erzeugnisses empfehlen wir stets, mindestens drei Packungen Material anzumischen.



Tipologia  
Type  
Typologie  
Typ  
Gres porcellanato smaltato  
Glazed porcelain  
Grès cérame emaille  
Feinsteinzeug glasiert

Formati  
Sizes  
Formats  
Formate  
60x120  
60x60  
30x60  
30x30  
10x30  
15x17 Esagona

Spessore  
Thickness  
Épaisseur  
Stärke  
9 mm

Resistenza scivolosità  
Sliding resistance  
Resistance au glissement  
Rutschfestigkeit  
R9

Grado di variazione cromatica  
Degree of colour change  
Degré de variation chromatique  
Grad der Farbabweichung  
V3

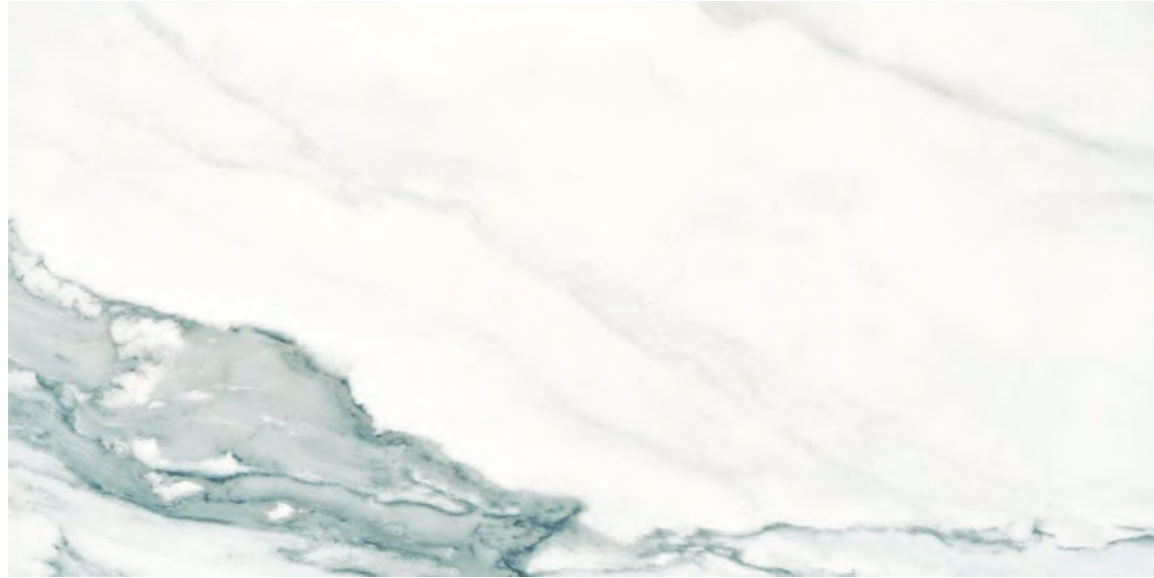

**601303**  
CALACATTA EMERALD NATURALE  
RETTIFICATO 60x120  
Cod. **94** □

**601304**  
CALACATTA EMERALD LAPPATO  
RETTIFICATO 60x120  
Cod. **103** □

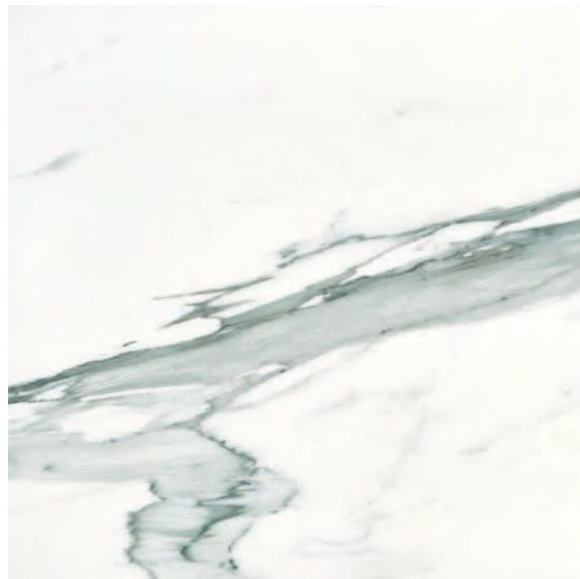

**606251**  
CALACATTA EMERALD NATURALE  
RETTIFICATO 60x60  
Cod. **79** □

**606252**  
CALACATTA EMERALD LAPPATO  
RETTIFICATO 60x60  
Cod. **93** □



**490766**  
CALACATTA EMERALD NATURALE  
RETTIFICATO 30x60  
Cod. **76** □

**490767**  
CALACATTA EMERALD LAPPATO  
RETTIFICATO 30x60  
Cod. **85** □



**041337**  
CALACATTA EMERALD NATURALE RETTIFICATO 30x30  
Cod. **78** □

**041338**  
CALACATTA EMERALD LAPPATO RETTIFICATO 30x30  
Cod. **90** □



**103139**  
CALACATTA EMERALD NATURALE  
RETTIFICATO 10x30  
Cod. **77** □

**103140**  
CALACATTA EMERALD LAPPATO  
RETTIFICATO 10x30  
Cod. **93** □



**041353**  
CALACATTA EMERALD NATURALE  
MOSAICO 5x5 SU RETE 30x30  
Cod. **24** ○

**041354**  
CALACATTA EMERALD LAPPATO  
MOSAICO 5x5 SU RETE 30x30  
Cod. **31** ○

6  
9,30 kg



**041361**  
CALACATTA EMERALD NATURALE  
MOSAICO ESAGONO SU RETE 27x28  
Cod. **136** ○

**041362**  
CALACATTA EMERALD LAPPATO  
MOSAICO ESAGONO SU RETE 27x28  
Cod. **49** ○

6  
8,90 kg



**041345**  
CALACATTA EMERALD NATURALE  
MOSAICO HB SU RETE 28x32  
Cod. **45** ○

**041346**  
CALACATTA EMERALD LAPPATO  
MOSAICO HB SU RETE 28x32  
Cod. **48** ○

6  
10,20 kg

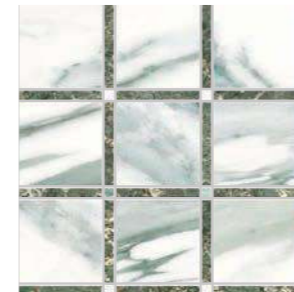

**041330**  
CALACATTA EMERALD NATURALE  
MOSAICO TIMELESS SU RETE 30x30  
Cod. **68** ○

**041329**  
CALACATTA EMERALD LAPPATO  
MOSAICO TIMELESS SU RETE 30x30  
Cod. **75** ○

6  
9,70 kg



**041322**  
CALACATTA EMERALD NATURALE  
MOSAICO ARABESQUE SU RETE 30x30  
Cod. **57** ○

**041321**  
CALACATTA EMERALD LAPPATO  
MOSAICO ARABESQUE SU RETE 30x30  
Cod. **72** ○

6  
9,70 kg



**230314**  
CALACATTA EMERALD NATURALE  
ESAGONA 15x17  
Cod. **137** □

**230315**  
CALACATTA EMERALD LAPPATO  
ESAGONA 15x17  
Cod. **113** □



**380311**  
CALACATTA EMERALD NATURALE  
BORDURA MURETTO 7x30  
Cod. **28** ○

**380310**  
CALACATTA EMERALD LAPPATO  
BORDURA MURETTO 7x30  
Cod. **28** ○

10  
3,60 kg



**380318**  
CALACATTA EMERALD NATURALE  
LONDON 5x30  
Cod. **33** ○

**380319**  
CALACATTA EMERALD LUCIDO  
LONDON 5x30  
Cod. **33** ○

24  
6,11 kg

**IMBALLI • PACKAGES • EMBALLAGES • FORMATE**

	SCATOLA • BOX • BOITE • KARTON			PALLET • PALLETS • PALETTE • PALETTE		
	pz	m <sup>q</sup>	kg	box	m <sup>q</sup>	kg
<b>60x120</b>	2	1,44	30,20	30	43,20	906,00
<b>60x60</b>	3	1,08	22,60	40	43,20	904,00
<b>30x60</b>	6	1,08	22,60	40	43,20	904,00
<b>30x30</b>	11	0,99	21,20	46	45,54	975,00
<b>10x30</b>	20	0,60	12,90	60	36,00	774,00
<b>15x17 Esagona</b>	30	0,57	11,00	56	31,92	616,00





## calacatta emerald RETT. LAPPATO

La finitura lappata è consigliata per uso rivestimento o per pavimenti da bagno in ambito residenziale. Nello specifico il tipo di pavimentazione deve essere non soggetta ad eccessive sollecitazioni e mai a diretto contatto con aree esterne. Come si verifica comunemente nelle pietre naturali l'eventuale presenza di puntini sulla superficie o di qualche disuniformità della lucentezza sono da considerare caratteristiche del prodotto derivanti dalla lavorazione a cui viene sottoposto.

The polished finish is recommended for wall coverings or for the floors of residential bathrooms. Specifically, floor coverings in this material must not be subjected to excessively heavy traffic and must never be in direct contact with outdoor areas. As is often the case with natural stones, any spots on the surface or any unevenness in shine are typical characteristics of the product, deriving from the process used.

La finitura lappata est recommandée pour le revêtement sol et mur des salles de bains résidentielles. Notamment, ce type de carreau au sol ne doit pas être exposé à des contraintes excessives, et il ne doit jamais être en contact direct avec des zones extérieures. Comme cela est souvent le cas pour les pierres naturelles, les micro trous éventuellement présents à la surface du produit ou l'hétérogénéité de son éclat forment des caractéristiques propres au façonnage.

Die polierte Oberfläche wird für Wandverkleidungen und Bodenbeläge in Privatbädern empfohlen. Der Bodenbelag darf keinen starken Beanspruchungen ausgesetzt sein und keinen direkten Kontakt zu Außenbereichen haben. Wie bei Natursteinen üblich, kann die Oberfläche Körnungen oder einen unregelmäßigen Glanz aufweisen. Diese Merkmale sind typische, beabsichtigte Produkteigenschaften, die durch das Bearbeitungsverfahren hervorgerufen werden.

Pezzi speciali • Special trims • Pièces spéciales • Formstücke

Battiscopa	44 22,40 kg	18 17,10 kg
	<b>290797</b> CALACATTA EMERALD NATURALE BATTISCOPA 7x30 Cod. <b>116</b> △	<b>290803</b> CALACATTA EMERALD NATURALE BATTISCOPA 7x60 Cod. <b>121</b> △
	<b>290800</b> CALACATTA EMERALD LAPPATO BATTISCOPA 7x30 Cod. <b>22</b> △	<b>290804</b> CALACATTA EMERALD LAPPATO BATTISCOPA 7x60 Cod. <b>26</b> △

CARATTERISTICHE DI QUALITÀ Quality characteristics Caractéristiques de qualité Qualitätseigenschaften	NORMA Norm Norme Norme	REQUISITO NORMA Required standards Valeur prescrite selon la norme Normvorgabe	RISULTATO Result Résultat Ergebnis
Assorbimento d'acqua Water absorption of the body Absorption d'eau de support Wasseraufnahme des Scherbens	ISO 10545-3	≤ 0,5	Conforme Conformity Conforme Gemäss
Resistenza a flessione Breaking strenght Résistance à la flexion Biegefestigkeit	ISO 10545-4	≥ 35 N/mm <sup>2</sup>	Conforme Conformity Conforme Gemäss
Resistenza all'abrasione Abrasion resistance Résistance à l'abrasion Abriebbeständigkeit	ISO 10545-7	CALACATTA EMERALD Rettificato	PEI IV
Resistenza al gelo Frost resistance Résistance au gel Frostbeständigkeit	ISO 10545-12	Nessun campione deve presentare rotture o alterazioni apprezzabili alla superficie No samples must show ruptures or noticeable surface alteration Aucuns enchantions doit présenter ruptures ou altérations appréciables de la surface Keines der Muster sollte Risse oder sichtbare Fehler der Oberfläche zeigen	Conforme Conformity Conforme Gemäss
Resistenza all'attacco chimico Chemical resistance Résistance à l'attaque chimique Beständigkeit gegen chemikalien	ISO 10545-13	CALACATTA EMERALD Naturale CALACATTA EMERALD Lappato	GA GLA GA GLB
Resistenza agli sbalzi termici Thermal shock resistance Résistance aux écarts de température Temperaturwechselbeständigkeit	ISO 10545-5		Conforme Conformity Conforme Gemäss
Resistenza scivolosità Sliding resistance Résistance au glissement Rutschfestigkeit	DIN 51130 R		R9
Significativa variazione Significant variation Variation important Bedeutsam Abweichung		CALACATTA EMERALD Rettificato	V3

**V1**  
Aspetto uniforme  
Uniform appearance  
Aspect uniforme  
Einheitliches Aussehen

**V2**  
Lieve variazione  
Slight variation  
Légère variation  
Geringe Abweichung

**V3**  
Significativa variazione  
Significant variation  
Variation important  
Bedeutsam Abweichung

**V4**  
Forte stonalizzazione  
Substantial variation  
Effet dénuancé très accentué  
Akzentuierte Variation

**PER UNA POSA OTTIMALE DEL PRODOTTO CONSIGLIAMO SEMPRE DI MESCOLARE ALMENO TRE SCATOLE DI MATERIALE.**

For the best product laying results, material from at least three boxes should be mixed.

Pour une pose excellente, nous recommandons toujours de mélanger le contenu d'au moins trois boîtes.

Für eine optimale Verlegung des Erzeugnisses empfehlen wir stets, mindestens drei Packungen Material anzumischen.



Tipologia  
Type  
Typologie  
Typ  
Gres porcellanato smaltato  
Glazed porcelain  
Grès cérame emaille  
Feinsteinzeug glasiert

Formati  
Sizes  
Formats  
Formate  
60x120  
60x60  
30x60  
30x30  
10x30  
15x17 Esagona

Spessore  
Thickness  
Épaisseur  
Stärke  
9 mm

Resistenza scivolosità  
Sliding resistance  
Resistance au glissement  
Rutschfestigkeit  
R9

Grado di variazione cromatica  
Degree of colour change  
Degré de variation chromatique  
Grad der Farbabweichung  
V3



**601294**  
CALACATTA ORO NATURALE  
RETTIFICATO 60x120  
Cod. **94** □

**601295**  
CALACATTA ORO LAPPATO  
RETTIFICATO 60x120  
Cod. **103** □



**606249**  
CALACATTA ORO NATURALE  
RETTIFICATO 60x60  
Cod. **79** □

**606250**  
CALACATTA ORO LAPPATO  
RETTIFICATO 60x60  
Cod. **93** □

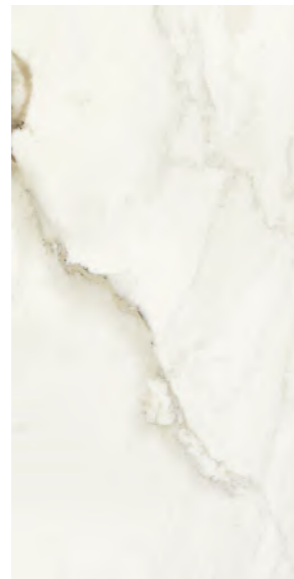

**490762**  
CALACATTA ORO NATURALE  
RETTIFICATO 30x60  
Cod. **76** □

**490763**  
CALACATTA ORO LAPPATO  
RETTIFICATO 30x60  
Cod. **85** □



**041335**  
CALACATTA ORO NATURALE RETTIFICATO 30x30  
Cod. **78** □

**041336**  
CALACATTA ORO LAPPATO RETTIFICATO 30x30  
Cod. **90** □



**103137**  
CALACATTA ORO NATURALE  
RETTIFICATO 10x30  
Cod. **77** □

**103138**  
CALACATTA ORO LAPPATO  
RETTIFICATO 10x30  
Cod. **93** □



**041351**  
CALACATTA ORO NATURALE  
MOSAICO 5x5 SU RETE 30x30  
Cod. **24** ○

**041352**  
CALACATTA ORO LAPPATO  
MOSAICO 5x5 SU RETE 30x30  
Cod. **31** ○

6  
9,30 kg



**041359**  
CALACATTA ORO NATURALE  
MOSAICO ESAGONO SU RETE 27x28  
Cod. **136** ○

**041360**  
CALACATTA ORO LAPPATO  
MOSAICO ESAGONO SU RETE 27x28  
Cod. **49** ○

6  
8,90 kg



**041343**  
CALACATTA ORO NATURALE  
MOSAICO HB SU RETE 28x32  
Cod. **45** ○

**041344**  
CALACATTA ORO LAPPATO  
MOSAICO HB SU RETE 28x32  
Cod. **48** ○

6  
10,20 kg

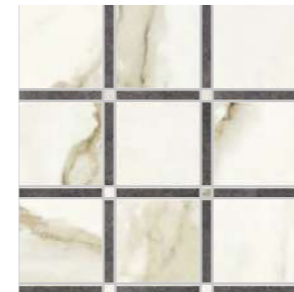

**041328**  
CALACATTA ORO NATURALE  
MOSAICO TIMELESS SU RETE 30x30  
Cod. **68** ○

**041327**  
CALACATTA ORO LAPPATO  
MOSAICO TIMELESS SU RETE 30x30  
Cod. **75** ○

6  
9,70 kg



**041320**  
CALACATTA ORO NATURALE  
MOSAICO ARABESQUE SU RETE 30x30  
Cod. **57** ○

**041319**  
CALACATTA ORO LAPPATO  
MOSAICO ARABESQUE SU RETE 30x30  
Cod. **72** ○

6  
9,70 kg



**230303**  
CALACATTA ORO NATURALE  
ESAGONA 15x17  
Cod. **137** □

**230304**  
CALACATTA ORO LAPPATO  
ESAGONA 15x17  
Cod. **113** □



**380309**  
CALACATTA ORO NATURALE  
BORDURA MURETTO 7x30  
Cod. **28** ○

**380308**  
CALACATTA ORO LAPPATO  
BORDURA MURETTO 7x30  
Cod. **28** ○

10  
3,60 kg



**380316**  
CALACATTA ORO NATURALE  
LONDON 5x30  
Cod. **33** ○

**380317**  
CALACATTA ORO LUCIDO  
LONDON 5x30  
Cod. **33** ○

24  
6,10 kg

IMBALLI • PACKAGES • EMBALLAGES • FORMATE

	SCATOLA • BOX • BOITE • KARTON			PALLET • PALLETS • PALETTE		
	pz	mq	kg	box	mq	kg
<b>60x120</b>	2	1,44	30,20	30	43,20	906,00
<b>60x60</b>	3	1,08	22,60	40	43,20	904,00
<b>30x60</b>	6	1,08	22,60	40	43,20	904,00
<b>30x30</b>	11	0,99	21,20	46	45,54	975,00
<b>10x30</b>	20	0,60	12,90	60	36,00	774,00
<b>15x17 Esagona</b>	30	0,57	11,00	56	31,92	616,00



## calacatta oro RETT. LAPPATO

La finitura lappata è consigliata per uso rivestimento o per pavimenti da bagno in ambito residenziale. Nello specifico il tipo di pavimentazione deve essere non soggetta ad eccessive sollecitazioni e mai a diretto contatto con aree esterne. Come si verifica comunemente nelle pietre naturali l'eventuale presenza di puntini sulla superficie o di qualche disuniformità della lucentezza sono da considerare caratteristiche del prodotto derivanti dalla lavorazione a cui viene sottoposto.

The polished finish is recommended for wall coverings or for the floors of residential bathrooms. Specifically, floor coverings in this material must not be subjected to excessively heavy traffic and must never be in direct contact with outdoor areas. As is often the case with natural stones, any spots on the surface or any unevenness in shine are typical characteristics of the product, deriving from the process used.

La finitura polie est recommandée pour le revêtement sol et mur des salles de bains résidentielles. Notamment, ce type de carreau au sol ne doit pas être exposé à des contraintes excessives, et il ne doit jamais être en contact direct avec des zones extérieures. Comme cela est souvent le cas pour les pierres naturelles, les micro trous éventuellement présents à la surface du produit ou l'hétérogénéité de son éclat forment des caractéristiques propres au façonnage.

Die polierte Oberfläche wird für Wandverkleidungen und Bodenbeläge in Privatbädern empfohlen. Der Bodenbelag darf keinen starken Beanspruchungen ausgesetzt sein und keinen direkten Kontakt zu Außenbereichen haben. Wie bei Natursteinen üblich, kann die Oberfläche Körnungen oder einen unregelmäßigen Glanz aufweisen. Diese Merkmale sind typische, beabsichtigte Produkteigenschaften, die durch das Bearbeitungsverfahren hervorgerufen werden.

Pezzi speciali • Special trims • Pièces spéciales • Formstücke

Battiscopa	44 22,40 kg	18 17,10 kg
	<b>290796</b> CALACATTA ORO NATURALE BATTISCOPA 7x30 Cod. <b>116</b> △	<b>290801</b> CALACATTA ORO NATURALE BATTISCOPA 7x60 Cod. <b>121</b> △
	<b>290799</b> CALACATTA ORO LAPPATO BATTISCOPA 7x30 Cod. <b>22</b> △	<b>290802</b> CALACATTA ORO LAPPATO BATTISCOPA 7x60 Cod. <b>26</b> △

CARATTERISTICHE DI QUALITÀ Quality characteristics Caractéristiques de qualité Qualitätseigenschaften	NORMA Norm Norme Norme	REQUISITO NORMA Required standards Valeur prescrite selon la norme Normvorgabe	RISULTATO Result Résultat Ergebniss
Assorbimento d'acqua Water absorption of the body Absorption d'eau de support Wasseraufnahme des Scherbens	ISO 10545-3	≤ 0,5	Conforme Conformity Conforme Gemäss
Resistenza a flessione Breaking strenght Résistance à la flexion Biegefestigkeit	ISO 10545-4	≥ 35 N/mm <sup>2</sup>	Conforme Conformity Conforme Gemäss
Resistenza all'abrasione Abrasion resistance Résistance à l'abrasion Abriebbeständigkeit	ISO 10545-7	CALACATTA ORO Rettificato	PEI IV
Resistenza al gelo Frost resistance Résistance au gel Frostbeständigkeit	ISO 10545-12	Nessun campione deve presentare rotture o alterazioni apprezzabili alla superficie No samples must show ruptures or noticeable surface alteration Aucuns enchantions doit présenter ruptures ou altérations appréciables de la surface Keines der Muster sollte Risse oder sichtbare Fehler der Oberfläche zeigen	Conforme Conformity Conforme Gemäss
Resistenza all'attacco chimico Chemical resistance Résistance à l'attaque chimique Beständigkeit gegen chemikalien	ISO 10545-13	CALACATTA ORO Naturale CALACATTA ORO Lappato	GA GLA GA GLB
Resistenza agli sbalzi termici Thermal shock resistance Résistance aux écarts de température Temperaturwechselbeständigkeit	ISO 10545-5		Conforme Conformity Conforme Gemäss
Resistenza scivolosità Sliding resistance Résistance au glissement Rutschfestigkeit	DIN 51130 R		R9
Significativa variazione Significant variation Variation important Bedeutsam Abweichung		CALACATTA ORO Rettificato	V3

V1 Aspetto uniforme Uniform appearance Aspect uniforme Einheitliches Aussehen	V2 Lieve variazione Slight variation Légère variation Geringe Abweichung	V3 Significativa variazione Significant variation Variation important Bedeutsam Abweichung	V4 Forte stonalizzazione Substantial variation Effet dénuancé très accentué Akzentuierte Variation
---	--	--	--

**PER UNA POSA OTTIMALE DEL PRODOTTO CONSIGLIAMO SEMPRE DI MESCOLARE ALMENO TRE SCATOLE DI MATERIALE.**

For the best product laying results, material from at least three boxes should be mixed.

Pour une pose excellente, nous recommandons toujours de mélanger le contenu d'au moins trois boîtes.

Für eine optimale Verlegung des Erzeugnisses empfehlen wir stets, mindestens drei Packungen Material anzumischen.

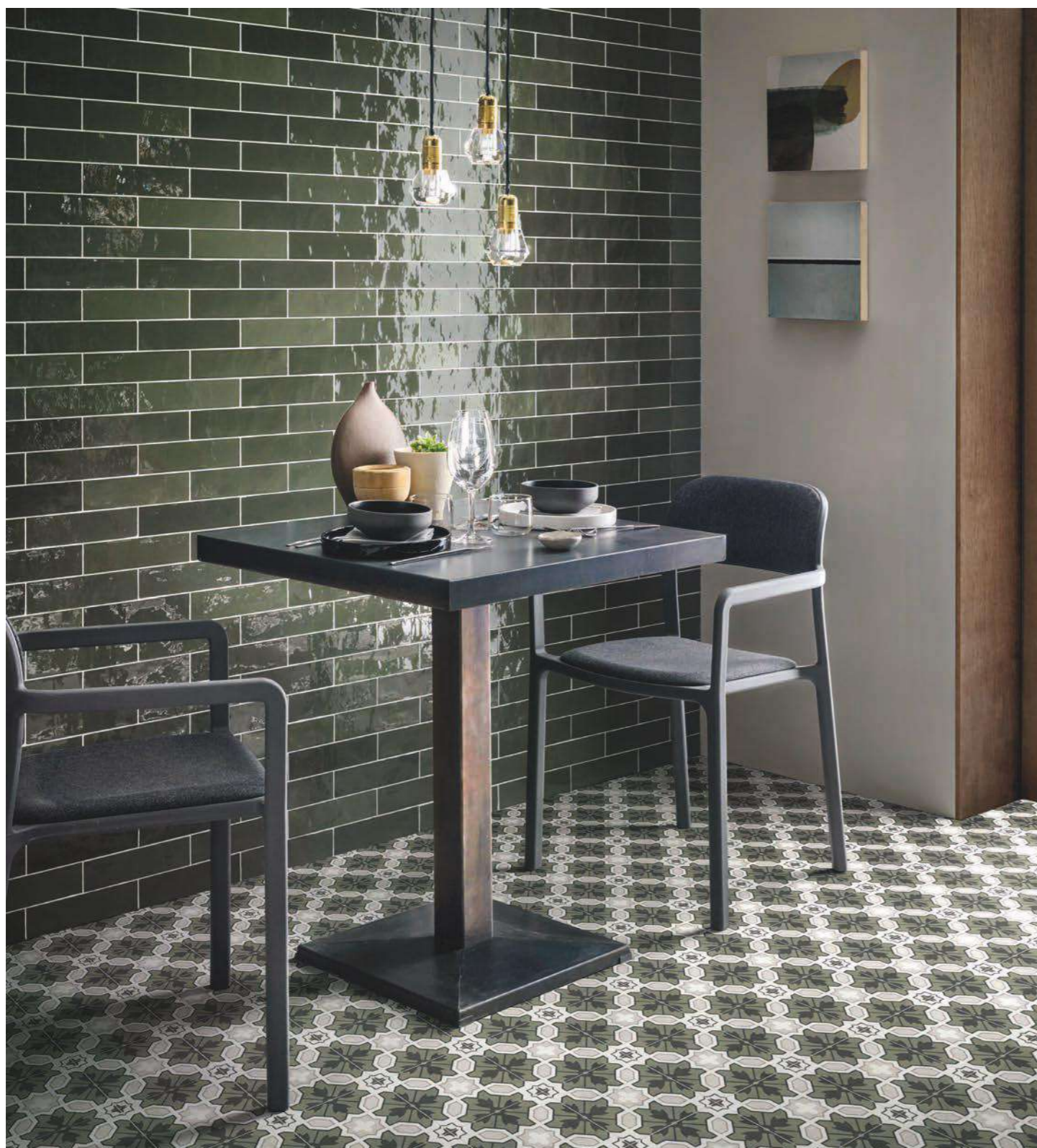

Tipologia  
Type  
Typologie  
Typ  
Gres porcellanato smaltato  
Glazed porcelain  
Grès cérame emaille  
Feinsteinzeug glasiert

20x20 (Cementine)  
22x25 (Esagone)

Rivestimento pasta bianca  
Revetement pate blanche  
White body walltile  
Weißscherbige Wandfliesen

10x40  
6,25x25  
12,5x12,5

Formati  
Sizes  
Formats  
Formate  
10x40  
6,25x25  
12,5x12,5  
20x20 (Cementine)  
22x25 (Esagone)

Spessore  
Thickness  
Épaisseur  
Stärke  
10 mm

Resistenza scivolosità  
Sliding resistance  
Resistance au glissement  
Rutschfestigkeit  
R10 (Cementine - Esagone)

Grado di variazione cromatica  
Degree of colour change  
Degré de variation chromatique  
Grad der Farbabweichung  
V1 - V3



**296006**  
COLOR ART DEEP GREEN GLOSSY  
6,25x25  
Cod. 141 □



**104012**  
COLOR ART DEEP GREEN GLOSSY  
10x40  
Cod. 85 □



**125007**  
COLOR ART DEEP GREEN GLOSSY  
12,5x12,5  
Cod. 141 □



**420440**  
COLOR ART DEEP GREEN GLOSSY  
Q-ROUND 1x25  
Cod. 15 ○



**296011**  
COLOR ART DARK TAUPE GLOSSY  
6,25x25  
Cod. 141 □



**104017**  
COLOR ART DARK TAUPE GLOSSY  
10x40  
Cod. 85 □



**125012**  
COLOR ART DARK TAUPE GLOSSY  
12,5x12,5  
Cod. 141 □



**420445**  
COLOR ART DARK TAUPE GLOSSY  
Q-ROUND 1x25  
Cod. 15 ○

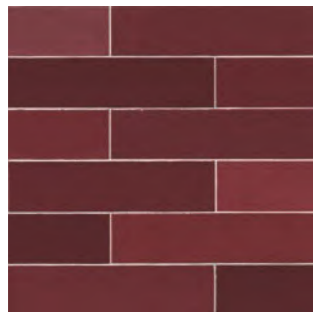

**296007**  
COLOR ART BURGUNDY GLOSSY  
6,25x25  
Cod. 141 □



**104013**  
COLOR ART BURGUNDY GLOSSY  
10x40  
Cod. 85 □

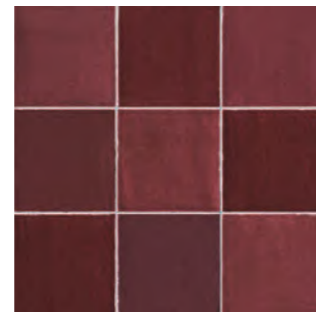

**125008**  
COLOR ART BURGUNDY GLOSSY  
12,5x12,5  
Cod. 141 □



**420441**  
COLOR ART BURGUNDY GLOSSY  
Q-ROUND 1x25  
Cod. 15 ○

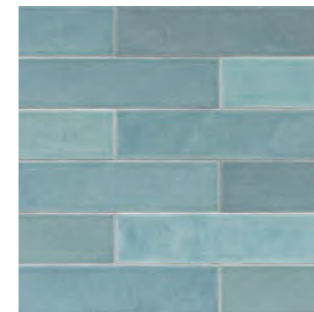

**296008**  
COLOR ART TURQUOISE GLOSSY  
6,25x25  
Cod. 141 □



**104014**  
COLOR ART TURQUOISE GLOSSY  
10x40  
Cod. 85 □

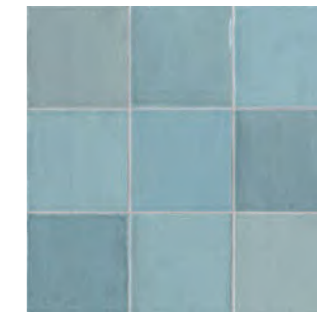

**125009**  
COLOR ART TURQUOISE GLOSSY  
12,5x12,5  
Cod. 141 □



**420442**  
COLOR ART TURQUOISE GLOSSY  
Q-ROUND 1x25  
Cod. 15 ○



**296009**  
COLOR ART LIGHT PINK GLOSSY  
6,25x25  
Cod. 141 □



**104015**  
COLOR ART LIGHT PINK GLOSSY  
10x40  
Cod. 85 □

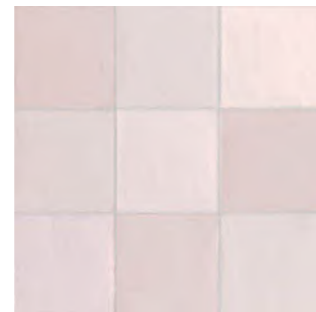

**125010**  
COLOR ART LIGHT PINK GLOSSY  
12,5x12,5  
Cod. 141 □



**420443**  
COLOR ART LIGHT PINK GLOSSY  
Q-ROUND 1x25  
Cod. 15 ○

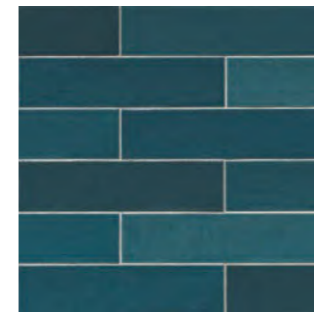

**296010**  
COLOR ART BLUE GLOSSY  
6,25x25  
Cod. 141 □



**104016**  
COLOR ART BLUE GLOSSY  
10x40  
Cod. 85 □

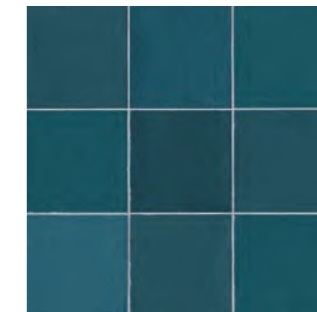

**125011**  
COLOR ART BLUE GLOSSY  
12,5x12,5  
Cod. 141 □



**420444**  
COLOR ART BLUE GLOSSY  
Q-ROUND 1x25  
Cod. 15 ○



IMBALLI • PACKAGES • EMBALLAGES • FORMATE

	SCATOLA • BOX • BOITE • KARTON			PALLET • PALLETS • PALETTS • PALETTE		
	pz	mq	kg	box	mq	kg
10x40	25	1,00	12,90	56	56,00	723,00
6,25x25	28	0,43	8,00	132	56,76	1.056,00
12,5x12,5	33	0,52	7,60	102	53,04	775,00

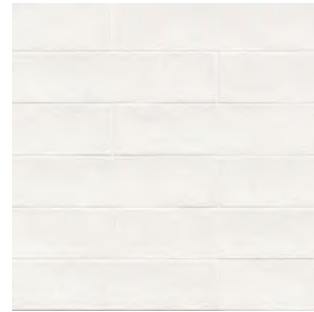

**296001**  
COLOR ART WHITE GLOSSY  
6,25x25  
Cod. 141 □

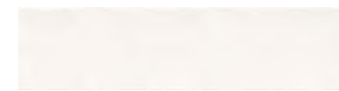

**104007**  
COLOR ART WHITE GLOSSY  
10x40  
Cod. 85 □

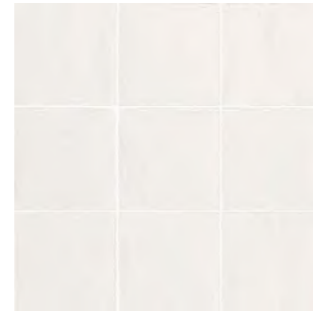

**125002**  
COLOR ART WHITE GLOSSY  
12,5x12,5  
Cod. 141 □



**420435**  
COLOR ART WHITE GLOSSY  
Q-ROUND 1x25  
Cod. 15 ○



**296000**  
COLOR ART WHITE MATT  
6,25x25  
Cod. 141 □



**104006**  
COLOR ART WHITE MATT  
10x40  
Cod. 85 □

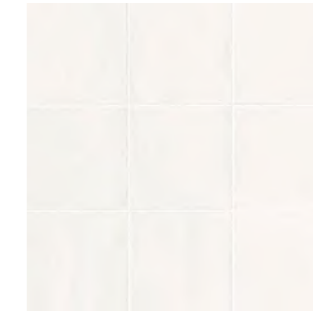

**125001**  
COLOR ART WHITE MATT  
12,5x12,5  
Cod. 141 □



**420434**  
COLOR ART WHITE MATT  
Q-ROUND 1x25  
Cod. 15 ○

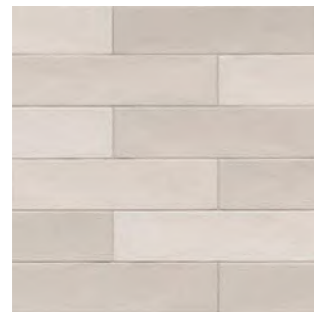

**296005**  
COLOR ART GREIGE GLOSSY  
6,25x25  
Cod. 141 □



**104011**  
COLOR ART GREIGE GLOSSY  
10x40  
Cod. 85 □

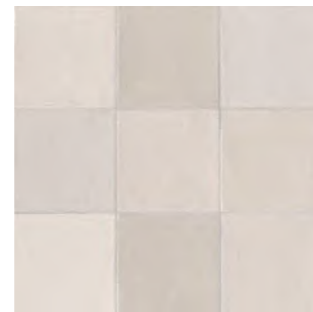

**125006**  
COLOR ART GREIGE GLOSSY  
12,5x12,5  
Cod. 141 □



**420439**  
COLOR ART GREIGE GLOSSY  
Q-ROUND 1x25  
Cod. 15 ○

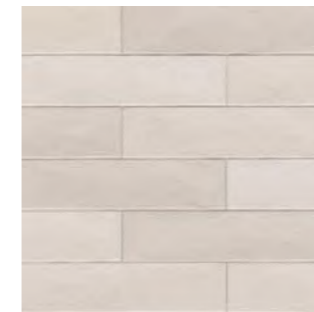

**296004**  
COLOR ART GREIGE MATT  
6,25x25  
Cod. 141 □



**104010**  
COLOR ART GREIGE MATT  
10x40  
Cod. 85 □

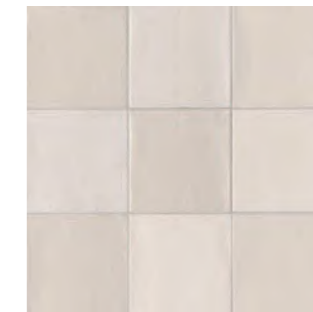

**125005**  
COLOR ART GREIGE MATT  
12,5x12,5  
Cod. 141 □



**420438**  
COLOR ART GREIGE MATT  
Q-ROUND 1x25  
Cod. 15 ○

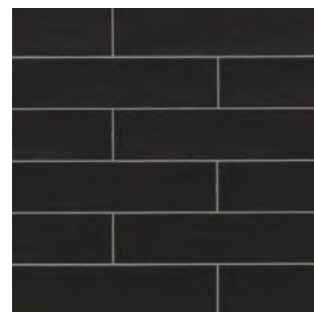

**296003**  
COLOR ART BLACK GLOSSY  
6,25x25  
Cod. 141 □



**104009**  
COLOR ART BLACK GLOSSY  
10x40  
Cod. 85 □

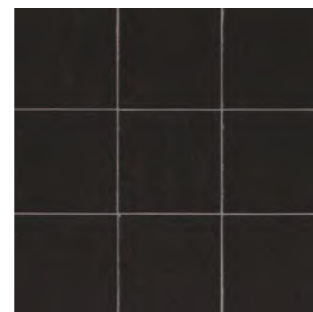

**125004**  
COLOR ART BLACK GLOSSY  
12,5x12,5  
Cod. 141 □



**420437**  
COLOR ART BLACK GLOSSY  
Q-ROUND 1x25  
Cod. 15 ○

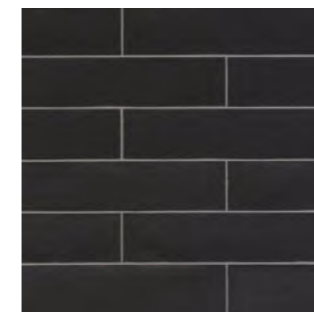

**296002**  
COLOR ART BLACK MATT  
6,25x25  
Cod. 141 □



**104008**  
COLOR ART BLACK MATT  
10x40  
Cod. 85 □



**125003**  
COLOR ART BLACK MATT  
12,5x12,5  
Cod. 141 □



**420436**  
COLOR ART BLACK MATT  
Q-ROUND 1x25  
Cod. 15 ○



IMBALLI • PACKAGES • EMBALLAGES • FORMATE

	SCATOLA • BOX • BOITE • KARTON			PALLET • PALLETS • PALETTS • PALETTE		
	pz	mq	kg	box	mq	kg
<b>10x40</b>						
<b>6,25x25</b>	28	0,43	8,00	132	56,76	1.056,00
<b>12,5x12,5</b>	33	0,52	7,60	102	53,04	775,00



**130082**  
COLOR 1  
DEEP GREEN  
RETTIFICATO 20x20  
Cod. 81 □



**130085**  
COLOR 4  
TURQUOISE  
RETTIFICATO 20x20  
Cod. 81 □



**252216**  
HEX WHITE MATT  
22x25 ESAGONA  
Cod. 85 □



**252214**  
HEX GREIGE MATT  
22x25 ESAGONA  
Cod. 85 □



**252215**  
HEX BLACK MATT  
22x25 ESAGONA  
Cod. 85 □



**130083**  
COLOR 2  
BURGUNDY  
RETTIFICATO 20x20  
Cod. 81 □

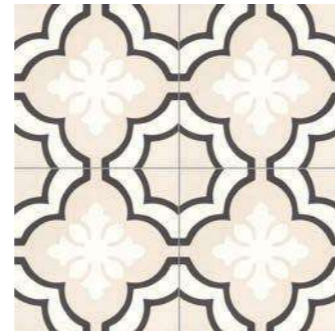

**130086**  
COLOR 5  
WHITE - BLACK - GREIGE  
RETTIFICATO 20x20  
Cod. 81 □



**130084**  
COLOR 3  
LIGHT PINK  
RETTIFICATO 20x20  
Cod. 81 □









IMBALLI • PACKAGES • EMBALLAGES • FORMATE





	SCATOLA • BOX • BOITE • KARTON			PALLET • PALLETS • PALETTS • PALETTE		
	pz	mq	kg	box	mq	kg
20x20	16	0,64	12,90	72	46,08	928,00
22x25 Esagona	9	0,37	7,12	72	26,64	513,00



## 10x40 - 6,25x25 - 12,5x12,5

CARATTERISTICHE DI QUALITÀ Quality characteristics Caractéristiques de qualité Qualitätseigenschaften	NORMA Norm Norme	REQUISITO NORMA Required standards Valeur prescrite selon la norme Normvorgabe	RISULTATO Result Résultat Ergebnis
 Assorbimento d'acqua Water absorption of the body Absorption d'eau de support Wasseraufnahme des Scherbens	ISO 10545-3	> 10%	Conforme Conformity Conforme Gemäss
 Resistenza a flessione Breaking strength Résistance à la flexion Biegefestigkeit	ISO 10545-4	≥ 12 N/mm <sup>2</sup> ≥ 600 N	Conforme Conformity Conforme Gemäss
 Resistenza all'attacco chimico Chemical resistance Résistance à l'attaque chimique Beständigkeit gegen chemikalien	ISO 10545-13	Nessun campione deve presentare rotture o alterazioni apprezzabili alla superficie No samples must show ruptures or noticeable surface alteration Aucuns enchantions doit présenter ruptures ou altérations appréciables de la surface Keines der Muster sollte Risse oder sichtbare Fehler der Oberfläche zeigen	GA GLA
 Resistenza alle macchie classe (1-5) Stain resistance class (1-5) Résistance aux taches (1-5) Fleckenbeständigkeit Klasse (1-5)	ISO 10545-14	Minimo classe 3 Class 3 min Classe 3 min Mindestwert Klasse 3	5
 Aspetto uniforme Uniform appearance Aspect uniforme Einheitliches Aussehen		Black - White	V1
 Significativa variazione Significant variation Variation important Bedeutsam Abweichung		Blue - Burgundy - Dark Taupe - Deep Green - Greige - Light Pink - Turquoise	V3

 Aspetto uniforme Uniform appearance Aspect uniforme Einheitliches Aussehen V1	 Lieve variazione Slight variation Légère variation Geringe Abweichung V2	 Significativa variazione Significant variation Variation important Bedeutsam Abweichung V3	 Forte stonizzazione Substantial variation Effet dénuancé très accentué Akzentuierte Variation V4
---	--	--	--









**PER UNA POSA OTTIMALE DEL PRODOTTO CONSIGLIAMO SEMPRE DI MESCOLARE ALMENO TRE SCATOLE DI MATERIALE.**

For the best product laying results, material from at least three boxes should be mixed.





Pour une pose excellente, nous recommandons toujours de mélanger le contenu d'au moins trois boîtes.

Für eine optimale Verlegung des Erzeugnisses empfehlen wir stets, mindestens drei Packungen Material anzumischen.

## Cementine - Esagone

CARATTERISTICHE DI QUALITÀ Quality characteristics Caractéristiques de qualité Qualitätseigenschaften	NORMA Norm Norme	REQUISITO NORMA Required standards Valeur prescrite selon la norme Normvorgabe	RISULTATO Result Résultat Ergebnis
 Assorbimento d'acqua Water absorption of the body Absorption d'eau de support Wasseraufnahme des Scherbens	ISO 10545-3	≤ 0,5	Conforme Conformity Conforme Gemäss
 Resistenza a flessione Breaking strength Résistance à la flexion Biegefestigkeit	ISO 10545-4	≥ 35 N/mm <sup>2</sup>	Conforme Conformity Conforme Gemäss
 Resistenza all'abrasione Abrasion resistance Résistance à l'abrasion Abriebbeständigkeit	ISO 10545-7		PEI IV
 Resistenza al gelo Frost resistance Résistance au gel Frostbeständigkeit	ISO 10545-12	Nessun campione deve presentare rotture o alterazioni apprezzabili alla superficie No samples must show ruptures or noticeable surface alteration Aucuns enchantions doit présenter ruptures ou altérations appréciables de la surface Keines der Muster sollte Risse oder sichtbare Fehler der Oberfläche zeigen	Conforme Conformity Conforme Gemäss
 Resistenza all'attacco chimico Chemical resistance Résistance à l'attaque chimique Beständigkeit gegen chemikalien	ISO 10545-13		GA GLA
 Resistenza agli sbalzi termici Thermal shock resistance Résistance aux écarts de température Temperaturwechselbeständigkeit	ISO 10545-5		Conforme Conformity Conforme Gemäss
 Resistenza scivolosità Sliding resistance Résistance au glissement Rutschfestigkeit	DIN 51130 R		R10
 Coefficiente d'attrito dinamico Wet dynamic coefficient of friction Coefficient de friction dynamique Reibungskoeffizient Schlipfbarkeit (in Bewegung)	Bot 3000 E	DCOF ≥ 0,42	> 0,42
 Aspetto uniforme Uniform appearance Aspect uniforme Einheitliches Aussehen			V1

 Aspetto uniforme Uniform appearance Aspect uniforme Einheitliches Aussehen V1	 Lieve variazione Slight variation Légère variation Geringe Abweichung V2	 Significativa variazione Significant variation Variation important Bedeutsam Abweichung V3	 Forte stonizzazione Substantial variation Effet dénuancé très accentué Akzentuierte Variation V4
---	--	--	--

**PER UNA POSA OTTIMALE DEL PRODOTTO CONSIGLIAMO SEMPRE DI MESCOLARE ALMENO TRE SCATOLE DI MATERIALE.**

For the best product laying results, material from at least three boxes should be mixed.

Pour une pose excellente, nous recommandons toujours de mélanger le contenu d'au moins trois boîtes.

Für eine optimale Verlegung des Erzeugnisses empfehlen wir stets, mindestens drei Packungen Material anzumischen.



Tipologia  
Type  
Typologie  
Typ  
Gres porcellanato smaltato  
Glazed porcelain  
Grès cérame emaille  
Feinsteinzeug glasiert

Formati  
Sizes  
Formats  
Formate  
60x120  
60x60  
30x60  
10x30

Spessore  
Thickness  
Épaisseur  
Stärke  
9 mm

Resistenza scivolosità  
Sliding resistance  
Resistance au glissement  
Rutschfestigkeit  
R9

Grado di variazione cromatica  
Degree of colour change  
Degré de variation chromatique  
Grad der Farbabweichung  
V3



**0601323**  
CORTINA WHITE  
RETTIFICATO 60x120  
Cod. **94** □



**0606269**  
CORTINA WHITE  
RETTIFICATO 60x60  
Cod. **87** □



**0490820**  
CORTINA WHITE  
RETTIFICATO 30x60  
Cod. **79** □



**0103150**  
CORTINA WHITE  
RETTIFICATO 10x30  
Cod. **87** □



6  
9,70 kg

**0041422**  
CORTINA WHITE  
MOSAICO 5x5 SU RETE 30x30  
Cod. **26** ○



6  
8,90 kg

**0041430**  
CORTINA WHITE  
MOSAICO ESAGONO SU RETE 27x28  
Cod. **45** ○



6  
9,80 kg

**0041438**  
CORTINA WHITE  
MOSAICO HB SU RETE 28x32  
Cod. **46** ○

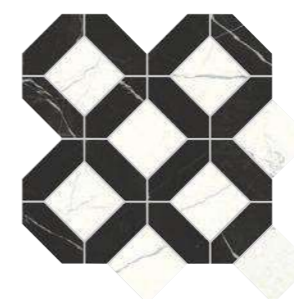

6  
9,80 kg

**0041447**  
CORTINA WHITE  
MOSAICO ANTIQUE LUX SU RETE 30x30  
Cod. **69** ○

IMBALLI • PACKAGES • EMBALLAGES • FORMATE

	SCATOLA • BOX • BOITE • KARTON			PALLET • PALLETS • PALETTS • PALETTE		
	<i>pz</i>	<i>mq</i>	<i>kg</i>	<i>box</i>	<i>mq</i>	<i>kg</i>
<b>60x120</b>	2	1,44	28,70	30	43,20	861,00
<b>60x60</b>	3	1,08	21,50	40	43,20	861,00
<b>30x60</b>	6	1,08	21,50	40	43,20	861,00
<b>10x30</b>	20	0,60	11,40	60	36,00	684,00



Pezzi speciali • Special trims • Pièces spéciales • Formstücke

Battiscopa

44  
17,20 kg

18  
14,80 kg

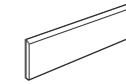

**0290838**  
CORTINA WHITE  
BATTISCOPA 7x30  
Cod. **19** △

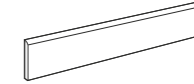

**0290846**  
CORTINA WHITE  
BATTISCOPA 7x60  
Cod. **23** △

CARATTERISTICHE DI QUALITÀ Quality characteristics Caractéristiques de qualité Qualitätseigenschaften	NORMA Norm Norme Norme	REQUISITO NORMA Required standards Valeur prescrite selon la norme Normvorgabe	RISULTATO Result Résultat Ergebniss
Assorbimento d'acqua Water absorption of the body Absorption d'eau de support Wasseraufnahme des Scherbens	ISO 10545-3	≤ 0,5	Conforme Conformity Conforme Gemäss
Resistenza a flessione Breaking strenght Résistance à la flexion Biegefestigkeit	ISO 10545-4	≥ 35 N/mm <sup>2</sup>	Conforme Conformity Conforme Gemäss
Resistenza all'abrasione Abrasion resistance Resistance a l'abrasion Abriebbeständigkeit	ISO 10545-7		PEI IV
Resistenza al gelo Frost resistance Résistance au gel Frostbeständigkeit	ISO 10545-12	Nessun campione deve presentare rotture o alterazioni apprezzabili alla superficie No samples must show ruptures or noticeable surface alteration Aucuns enchantions doit présenter ruptures ou altérations appréciables de la surface Keines der Muster sollte Risse oder sichtbare Fehler der Oberfläche zeigen	Conforme Conformity Conforme Gemäss
Resistenza all'attacco chimico Chemical resistance Résistance à l'attaque chimique Beständigkeit gegen chemikalien	ISO 10545-13		GA GLA
Resistenza agli sbalzi termici Thermal shock resistance Resistance aux écarts de température Temperaturwechselbeständigkeit	ISO 10545-5		Conforme Conformity Conforme Gemäss
Resistenza scivolosità Sliding resistance Resistance au glissement Rutschfestigkeit	DIN 51130 R		R9
Coefficiente d'attrito dinamico Wet dynamic coefficient of friction Coefficient de friction dynamique Reibungskoeffizient Schlupfrigkeit (in Bewegung)	Bot 3000 E	DCOF ≥ 0,42	> 0,42
Significativa variazione Significant variation Variation important Bedeutsam Abweichung			V3

**V1**  
Aspetto uniforme  
Uniform appearance  
Aspect uniforme  
Einheitliches Aussehen

**V2**  
Lieve variazione  
Slight variation  
Légère variation  
Geringe Abweichung

**V3**  
Significativa variazione  
Significant variation  
Variation important  
Bedeutsam Abweichung

**V4**  
Forte stonalizzazione  
Substantial variation  
Effet dénuancé très accentué  
Akzentuierte Variation

**PER UNA POSA OTTIMALE DEL PRODOTTO CONSIGLIAMO SEMPRE DI MESCOLARE ALMENO TRE SCATOLE DI MATERIALE.**

For the best product laying results, material from at least three boxes should be mixed.

Pour une pose excellente, nous recommandons toujours de mélanger le contenu d'au moins trois boîtes.

Für eine optimale Verlegung des Erzeugnisses empfehlen wir stets, mindestens drei Packungen Material anzumischen.



Tipologia  
Type  
Typologie  
Typ  
Gres porcellanato smaltato  
Glazed porcelain  
Grès cérame emaille  
Feinsteinzeug glasiert

Formati  
Sizes  
Formats  
Formate  
Esagona 25x22  
20x20  
5x20

Spessore  
Thickness  
Épaisseur  
Stärke  
10 mm

Resistenza scivolosità  
Sliding resistance  
Resistance au glissement  
Rutschfestigkeit  
R10

Grado di variazione cromatica  
Degree of colour change  
Degré de variation chromatique  
Grad der Farbabweichung  
V2



**130058**  
DECO STYLE WHITE GLOSSY RETTIFICATO 20x20  
Cod. **81** □

**130057**  
DECO STYLE WHITE MATT RETTIFICATO 20x20  
Cod. **81** □



**050218**  
DECO STYLE WHITE GLOSSY RETTIFICATO 5x20  
Cod. **103** □

**050217**  
DECO STYLE WHITE MATT RETTIFICATO 5x20  
Cod. **103** □



**252202**  
DECO STYLE ESAGONA WHITE GLOSSY NATURALE 25x22  
Cod. **85** □

**252201**  
DECO STYLE ESAGONA WHITE MATT NATURALE 25x22  
Cod. **85** □



**130060**  
DECO STYLE BEIGE GLOSSY RETTIFICATO 20x20  
Cod. **81** □

**130059**  
DECO STYLE BEIGE MATT RETTIFICATO 20x20  
Cod. **81** □



**050220**  
DECO STYLE BEIGE GLOSSY RETTIFICATO 5x20  
Cod. **103** □

**050219**  
DECO STYLE BEIGE MATT RETTIFICATO 5x20  
Cod. **103** □



**252204**  
DECO STYLE ESAGONA BEIGE GLOSSY NATURALE 25x22  
Cod. **85** □

**252203**  
DECO STYLE ESAGONA BEIGE MATT NATURALE 25x22  
Cod. **85** □



**262602**  
DECO STYLE DECORO HYDRO - MED  
WHITE /BEIGE GLOSSY SU RETE 25,6x25,6  
Cod. **69** ○

**262605**  
DECO STYLE DECORO HYDRO - MED  
WHITE /BEIGE MATT SU RETE 25,6x25,6  
Cod. **69** ○



**262601**  
DECO STYLE DECORO HYDRO - MED  
WHITE /GREY GLOSSY SU RETE 25,6x25,6  
Cod. **69** ○

**262604**  
DECO STYLE DECORO HYDRO - MED  
WHITE /GREY MATT SU RETE 25,6x25,6  
Cod. **69** ○

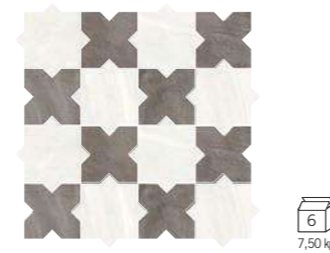

**262603**  
DECO STYLE DECORO HYDRO - MED  
WHITE /CHARCOAL GLOSSY SU RETE 25,6x25,6  
Cod. **69** ○

**262606**  
DECO STYLE DECORO HYDRO - MED  
WHITE /CHARCOAL MATT SU RETE 25,6x25,6  
Cod. **69** ○

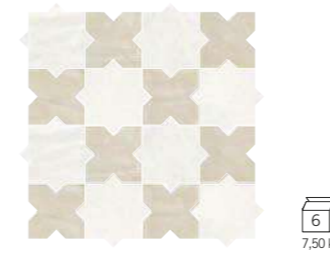

**262602**  
DECO STYLE DECORO HYDRO - MED  
WHITE /BEIGE GLOSSY SU RETE 25,6x25,6  
Cod. **69** ○

**262605**  
DECO STYLE DECORO HYDRO - MED  
WHITE /BEIGE MATT SU RETE 25,6x25,6  
Cod. **69** ○



**041187**  
DECO STYLE WHITE MOSAICO  
GLOSSY 5x5 SU RETE 20x20  
Cod. **16** ○

**041191**  
DECO STYLE WHITE MOSAICO  
MATT 5x5 SU RETE 20x20  
Cod. **16** ○



**450385**  
DECO STYLE BULLNOSE  
WHITE GLOSSY RETTIFICATO 5x20  
Cod. **116** △

**450389**  
DECO STYLE BULLNOSE  
WHITE MATT RETTIFICATO 5x20  
Cod. **116** △



**380280**  
DECO STYLE WHITE MATT  
LONDON 3x20  
Cod. **22** ○

**380279**  
DECO STYLE WHITE GLOSSY  
LONDON 3x20  
Cod. **22** ○



**041188**  
DECO STYLE BEIGE MOSAICO  
GLOSSY 5x5 SU RETE 20x20  
Cod. **16** ○

**041192**  
DECO STYLE BEIGE MOSAICO  
MATT 5x5 SU RETE 20x20  
Cod. **16** ○



**450386**  
DECO STYLE BULLNOSE  
BEIGE GLOSSY RETTIFICATO 5x20  
Cod. **116** △

**450390**  
DECO STYLE BULLNOSE  
BEIGE MATT RETTIFICATO 5x20  
Cod. **116** △



**380274**  
DECO STYLE BEIGE MATT  
LONDON 3x20  
Cod. **22** ○

**380273**  
DECO STYLE BEIGE GLOSSY  
LONDON 3x20  
Cod. **22** ○

IMBALLI • PACKAGES • EMBALLAGES • FORMATE

	SCATOLA • BOX • BOITE • KARTON			PALLET • PALLETS • PALETTS • PALETTE		
	pz	mq	kg	box	mq	kg
<b>Esagona 25x22</b>	9	0,37	8,50	72	26,64	630,00
<b>20x20</b>	16	0,64	13,70	72	46,08	1.010,00
<b>5x20</b>	56	0,56	12,00	60	33,60	745,00

IMBALLI • PACKAGES • EMBALLAGES • FORMATE

	SCATOLA • BOX • BOITE • KARTON			PALLET • PALLETS • PALETTS • PALETTE		
	pz	mq	kg	box	mq	kg
<b>Esagona 25x22</b>	9	0,37	8,50	72	26,64	630,00
<b>20x20</b>	16	0,64	13,70	72	46,08	1.010,00
<b>5x20</b>	56	0,56	12,00	60	33,60	745,00



**130062**  
DECO STYLE GREY GLOSSY RETTIFICATO 20x20  
Cod. **81** □

**130061**  
DECO STYLE GREY MATT RETTIFICATO 20x20  
Cod. **81** □



**050222**  
DECO STYLE GREY GLOSSY RETTIFICATO 5x20  
Cod. **103** □

**050221**  
DECO STYLE GREY MATT RETTIFICATO 5x20  
Cod. **103** □



**252206**  
DECO STYLE ESAGONA GREY GLOSSY NATURALE 25x22  
Cod. **85** □

**252205**  
DECO STYLE ESAGONA GREY MATT NATURALE 25x22  
Cod. **85** □

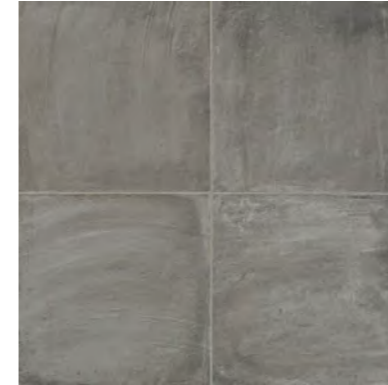

**130064**  
DECO STYLE CHARCOAL GLOSSY RETTIFICATO 20x20  
Cod. **81** □

**130063**  
DECO STYLE CHARCOAL MATT RETTIFICATO 20x20  
Cod. **81** □



**050224**  
DECO STYLE CHARCOAL GLOSSY RETTIFICATO 5x20  
Cod. **103** □

**050223**  
DECO STYLE CHARCOAL MATT RETTIFICATO 5x20  
Cod. **103** □



**252208**  
DECO STYLE ESAGONA CHARCOAL GLOSSY NATURALE 25x22  
Cod. **85** □

**252207**  
DECO STYLE ESAGONA CHARCOAL MATT NATURALE 25x22  
Cod. **85** □

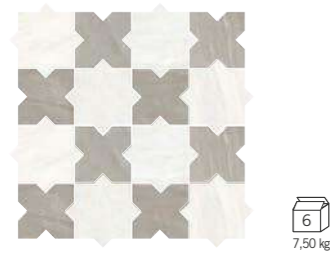

**262601**  
DECO STYLE DECORO HYDRO - MED  
WHITE /GREY GLOSSY SU RETE 25,6x25,6  
Cod. **69** ○

**262604**  
DECO STYLE DECORO HYDRO - MED  
WHITE /GREY MATT SU RETE 25,6x25,6  
Cod. **69** ○



**262603**  
DECO STYLE DECORO HYDRO - MED  
WHITE /CHARCOAL GLOSSY SU RETE 25,6x25,6  
Cod. **69** ○

**262606**  
DECO STYLE DECORO HYDRO - MED  
WHITE /CHARCOAL MATT SU RETE 25,6x25,6  
Cod. **69** ○

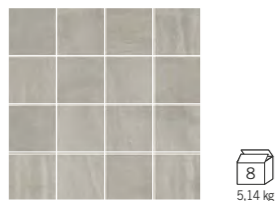

**041189**  
DECO STYLE GREY MOSAICO  
GLOSSY 5x5 SU RETE 20x20  
Cod. **16** ○

**041193**  
DECO STYLE GREY MOSAICO  
MATT 5x5 SU RETE 20x20  
Cod. **16** ○



**450387**  
DECO STYLE BULLNOSE  
GREY GLOSSY RETTIFICATO 5x20  
Cod. **116** △

**450391**  
DECO STYLE BULLNOSE  
GREY MATT RETTIFICATO 5x20  
Cod. **116** △



**380278**  
DECO STYLE GREY MATT  
LONDON 3x20  
Cod. **22** ○

**380277**  
DECO STYLE GREY GLOSSY  
LONDON 3x20  
Cod. **22** ○



**041190**  
DECO STYLE CHARCOAL MOSAICO  
GLOSSY 5x5 SU RETE 20x20  
Cod. **16** ○

**041194**  
DECO STYLE CHARCOAL MOSAICO  
MATT 5x5 SU RETE 20x20  
Cod. **16** ○



**450388**  
DECO STYLE BULLNOSE  
CHARCOAL GLOSSY RETTIFICATO 5x20  
Cod. **116** △

**450392**  
DECO STYLE BULLNOSE  
CHARCOAL MATT RETTIFICATO 5x20  
Cod. **116** △



**380276**  
DECO STYLE CHARCOAL MATT  
LONDON 3x20  
Cod. **22** ○

**380275**  
DECO STYLE CHARCOAL GLOSSY  
LONDON 3x20  
Cod. **22** ○

IMBALLI • PACKAGES • EMBALLAGES • FORMATE

	SCATOLA • BOX • BOITE • KARTON			PALLET • PALLETS • PALETTS • PALETTE		
	pz	mq	kg	box	mq	kg
<b>Esagona 25x22</b>	9	0,37	8,50	72	26,64	630,00
<b>20x20</b>	16	0,64	13,70	72	46,08	1.010,00
<b>5x20</b>	56	0,56	12,00	60	33,60	745,00

IMBALLI • PACKAGES • EMBALLAGES • FORMATE

	SCATOLA • BOX • BOITE • KARTON			PALLET • PALLETS • PALETTS • PALETTE		
	pz	mq	kg	box	mq	kg
<b>Esagona 25x22</b>	9	0,37	8,50	72	26,64	630,00
<b>20x20</b>	16	0,64	13,70	72	46,08	1.010,00
<b>5x20</b>	56	0,56	12,00	60	33,60	745,00



**050226**  
DECO STYLE BLEND GLOSSY RETTIFICATO 5x20  
Cod. **103**  12,30 kg

**050225**  
DECO STYLE BLEND MATT RETTIFICATO 5x20  
Cod. **103** 



**130068**  
DECO STYLE CEM 1 GLOSSY RETTIFICATO 20x20  
Cod. **81**  13,50 kg

**130065**  
DECO STYLE CEM 1 MATT RETTIFICATO 20x20  
Cod. **81** 



**130069**  
DECO STYLE CEM 2 GLOSSY RETTIFICATO 20x20  
Cod. **81**  13,50 kg

**130066**  
DECO STYLE CEM 2 MATT RETTIFICATO 20x20  
Cod. **81** 







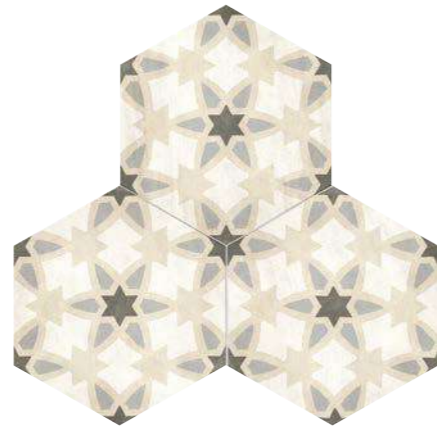





**252212**  
DECO STYLE CEM 3 ESAGONA GLOSSY NATURALE 25x22  
Cod. **85**  8,50 kg

**252209**  
DECO STYLE CEM 3 ESAGONA MATT NATURALE 25x22  
Cod. **85** 





**252213**  
DECO STYLE CEM 4 ESAGONA GLOSSY NATURALE 25x22  
Cod. **85**  8,50 kg

**252210**  
DECO STYLE CEM 4 ESAGONA MATT NATURALE 25x22  
Cod. **85** 

CARATTERISTICHE DI QUALITÀ Quality characteristics Caractéristiques de qualité Qualitätseigenschaften	NORMA Norm Norme Norme	REQUISITO NORMA Required standards Valeur prescrite selon la norme Normvorgabe	RISULTATO Result Résultat Ergebniss
 Assorbimento d'acqua Water absorption of the body Absorption d'eau de support Wasseraufnahme des Scherbens	ISO 10545-3	≤ 0,5	Conforme Conformity Conforme Gemäss
 Resistenza a flessione Breaking strenght Résistance à la flexion Biegefestigkeit	ISO 10545-4	≥ 35 N/mm <sup>2</sup>	Conforme Conformity Conforme Gemäss
 Resistenza all'abrasione Abrasion resistance Résistance à l'abrasion Abriebbestaendigkeit	ISO 10545-7	Matt	PEI IV
		Glossy	PEI III
 Resistenza al gelo Frost resistance Résistance au gel Frostbeständigkeit	ISO 10545-12	Nessun campione deve presentare rotture o alterazioni apprezzabili alla superficie No samples must show ruptures or noticeable surface alteration Aucuns enchantions doit présenter ruptures ou altérations appréciables de la surface Keines der Muster sollte Risse oder sichtbare Fehler der Oberflaeche zeigen	Conforme Conformity Conforme Gemäss
 Resistenza all'attacco chimico Chemical resistance Résistance à l'attaque chimique Beständigkeit gegen chemikalien	ISO 10545-13		GA GLA
 Resistenza agli sbalzi termici Thermal shock resistance Résistance aux ecart de température Temperaturwechselbeständigkeit	ISO 10545-5		Conforme Conformity Conforme Gemäss
 Resistenza scivolosità Sliding resistance Résistance au glissement Rutschfestigkeit	DIN 51130 R		R10 Matt
 Coefficiente d'attrito dinamico Wet dynamic coefficient of friction Coefficient de friction dynamique Reibungskoeffizient schlüpfrigkeit (in bewegung)	Bot 3000 E	DCOF ≥ 0,42	≥ 0,42 Matt
 Lieve variazione Slight variation Légère variation Geringe Abweichung			V2

 **V1**  
Aspetto uniforme  
Uniform appearance  
Aspect uniforme  
Einheitliches Aussehen

 **V2**  
Lieve variazione  
Slight variation  
Légère variation  
Geringe Abweichung

 **V3**  
Significativa variazione  
Significant variation  
Variation important  
Bedeutsam Abweichung

 **V4**  
Forte stonizzazione  
Substantial variation  
Effet dénuancé très accentué  
Akzentuierte Variation

**PER UNA POSA OTTIMALE DEL PRODOTTO CONSIGLIAMO SEMPRE DI MESCOLARE ALMENO TRE SCATOLE DI MATERIALE.**

For the best product laying results, material from at least three boxes should be mixed.

Pour une pose excellente, nous recommandons toujours de mélanger le contenu d'au moins trois boîtes.

Für eine optimale Verlegung des Erzeugnisses empfehlen wir stets, mindestens drei Packungen Material anzumischen.





Tipologia  
Type  
Typologie  
Typ  
Gres porcellanato smaltato  
Glazed porcelain  
Grès cérame emaille  
Feinsteinzeug glasiert

Formati  
Sizes  
Formats  
Formate  
60x120  
30x120  
60x60  
30x60  
30x30  
10x30  
20x20

Spessore  
Thickness  
Épaisseur  
Stärke  
10 mm

Resistenza scivolosità  
Sliding resistance  
Resistance au glissement  
Rutschfestigkeit  
R10 / A+B

Grado di variazione cromatica  
Degree of colour change  
Degré de variation chromatique  
Grad der Farbabweichung  
V2

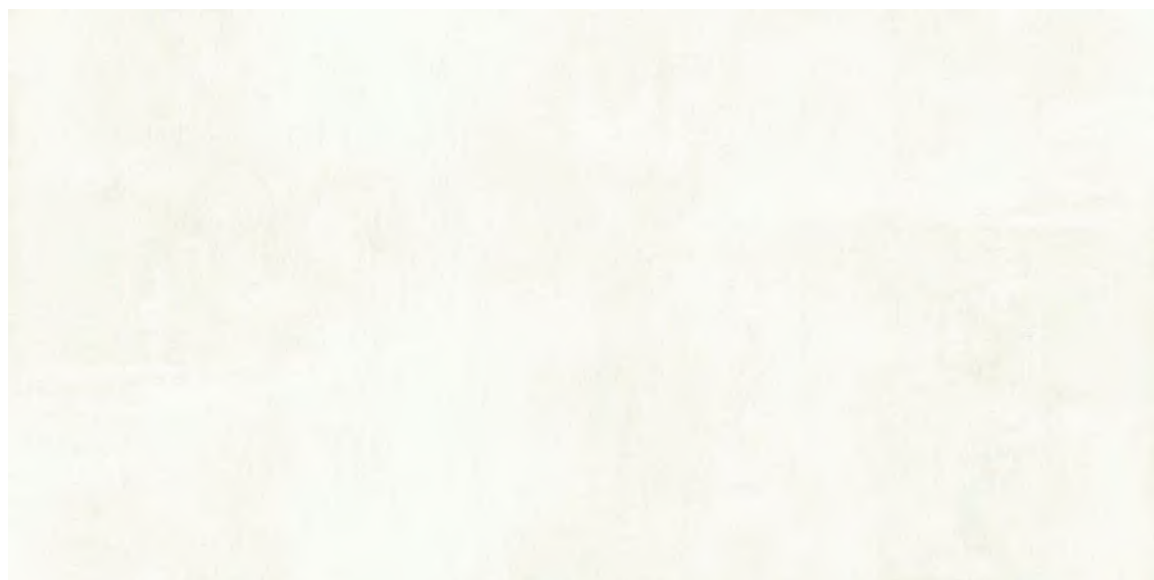

**601253**  
FACTORY WHITE RETTIFICATO 60x120  
Cod. **94** □



**301248**  
FACTORY WHITE RETTIFICATO 30x120  
Cod. **99** □



**606197**  
FACTORY WHITE RETTIFICATO 60x60  
Cod. **79** □



**490600**  
FACTORY WHITE RETTIFICATO 30x60  
Cod. **76** □



**130053**  
FACTORY WHITE RETTIFICATO 20x20  
Cod. **120** □

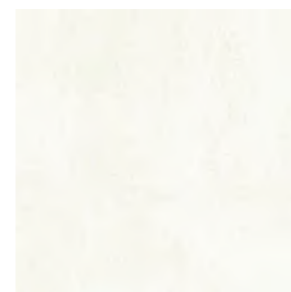

**041107**  
FACTORY WHITE RETTIFICATO 30x30  
Cod. **78** □

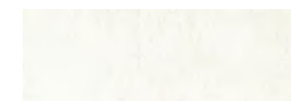

**103098**  
FACTORY WHITE RETTIFICATO 10x30  
Cod. **77** □

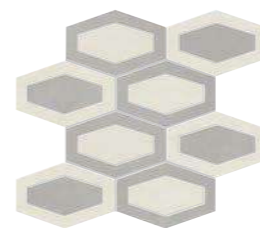

**041168**  
FACTORY WHITE/GREY  
MOSAICO CITIZEN SU RETE 26,1x26,1  
Cod. **38** ○

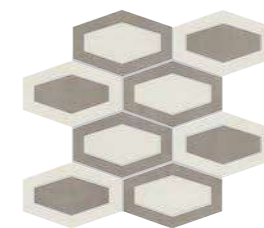

**041169**  
FACTORY WHITE/SMOKE  
MOSAICO CITIZEN SU RETE 26,1x26,1  
Cod. **38** ○



**041111**  
FACTORY WHITE  
MOSAICO ESAGONO SU RETE 30x26  
Cod. **128** ○



8,80 kg



5,20 kg



5,20 kg



5,20 kg



**041115**  
FACTORY WHITE MOSAICO 5x5  
SU RETE 30x30 Cod. **24** ○



10,00 kg

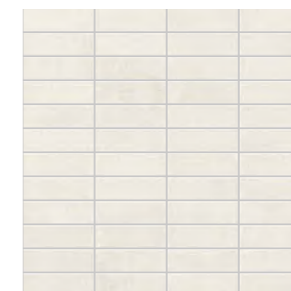

**041154**  
FACTORY WHITE MOSAICO 2,5x7,5  
SU RETE 30x30 Cod. **24** ○



9,80 kg

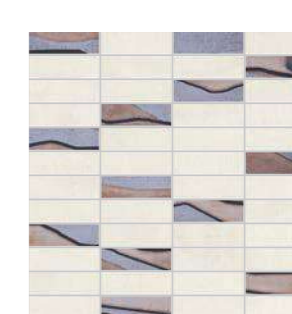

**041158**  
FACTORY WHITE MOSAICO METAL 2,5x7,5  
SU RETE 30x30 Cod. **38** ○



9,80 kg



**380262**  
FACTORY WHITE LISTELLO METAL 5x30  
Cod. **4** ○



7,30 kg

IMBALLI • PACKAGES • EMBALLAGES • FORMATE

	SCATOLA • BOX • BOITE • KARTON			PALLET • PALLETS • PALETTS • PALETTE		
	pz	mq	kg	box	mq	kg
<b>60x120</b>	2	1,44	32,40	30	43,20	978,00
<b>30x120</b>	3	1,08	26,50	42	45,36	1.133,00
<b>60x60</b>	3	1,08	23,60	40	43,20	965,00
<b>30x60</b>	6	1,08	26,00	40	43,20	960,00
<b>30x30</b>	11	0,99	21,80	46	45,54	1.025,00
<b>10x30</b>	20	0,60	13,00	60	36,00	800,00
<b>20x20</b>	25	1,00	23,00	51	51,00	1.200,00



**601254**  
FACTORY GREY RETTIFICATO 60x120  
Cod. **94** □



**301249**  
FACTORY GREY RETTIFICATO 30x120  
Cod. **99** □



**606198**  
FACTORY GREY RETTIFICATO 60x60  
Cod. **79** □

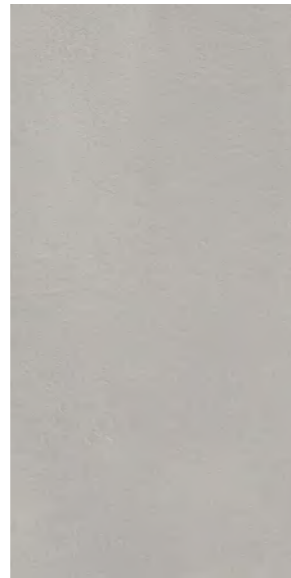

**490601**  
FACTORY GREY RETTIFICATO 30x60  
Cod. **76** □



**041108**  
FACTORY GREY RETTIFICATO 30x30  
Cod. **78** □



**130054**  
FACTORY GREY RETTIFICATO 20x20  
Cod. **120** □



**103099**  
FACTORY GREY RETTIFICATO 10x30  
Cod. **77** □

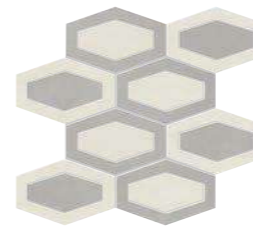

**041168**  
FACTORY WHITE/GREY  
MOSAICO CITIZEN SU RETE 26,1x26,1  
Cod. **38** ○



5,20 kg

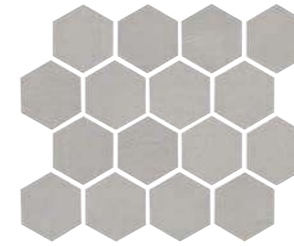

**041112**  
FACTORY GREY  
MOSAICO ESAGONO SU RETE 30x26  
Cod. **128** ○



8,80 kg

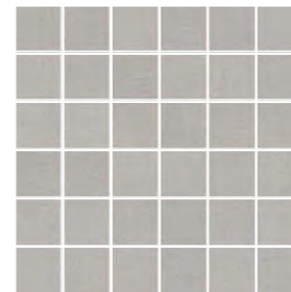

**041116**  
FACTORY GREY MOSAICO 5x5  
SU RETE 30x30 Cod. **24** ○



10,00 kg

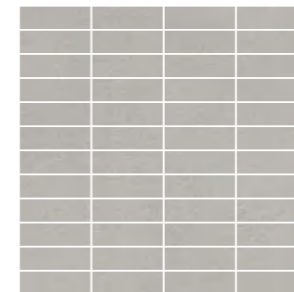

**041155**  
FACTORY GREY MOSAICO 2,5x7,5  
SU RETE 30x30 Cod. **24** ○



9,80 kg

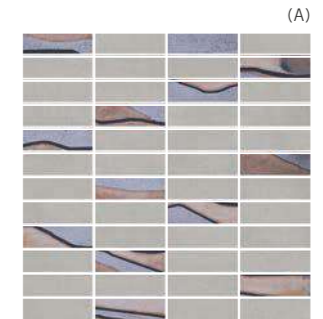

**041159**  
FACTORY GREY MOSAICO METAL 2,5x7,5  
SU RETE 30x30 Cod. **38** ○



9,80 kg



**380263**  
FACTORY GREY LISTELLO METAL 5x30  
Cod. **4** ○



7,30 kg

IMBALLI • PACKAGES • EMBALLAGES • FORMATE

	SCATOLA • BOX • BOITE • KARTON			PALLET • PALLETS • PALETTS • PALETTE		
	pz	mq	kg	box	mq	kg
<b>60x120</b>	2	1,44	32,40	30	43,20	978,00
<b>30x120</b>	3	1,08	26,50	42	45,36	1.133,00
<b>60x60</b>	3	1,08	23,60	40	43,20	965,00
<b>30x60</b>	6	1,08	26,00	40	43,20	960,00
<b>30x30</b>	11	0,99	21,80	46	45,54	1.025,00
<b>10x30</b>	20	0,60	13,00	60	36,00	800,00
<b>20x20</b>	25	1,00	23,00	51	51,00	1.200,00



**606199**  
FACTORY SMOKE RETTIFICATO 60x60  
Cod. **79** □



**490602**  
FACTORY SMOKE RETTIFICATO 30x60  
Cod. **76** □

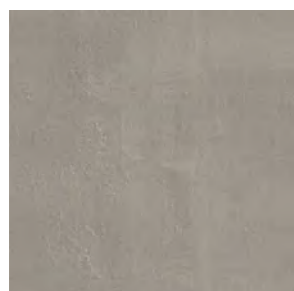

**041109**  
FACTORY SMOKE RETTIFICATO 30x30  
Cod. **78** □

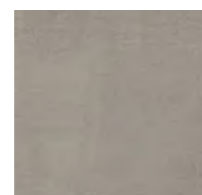

**130055**  
FACTORY SMOKE RETTIFICATO 20x20  
Cod. **120** □



**103100**  
FACTORY SMOKE RETTIFICATO 10x30  
Cod. **77** □



6  
10,00 kg

**041117**  
FACTORY SMOKE MOSAICO 5x5  
SU RETE 30x30 Cod. **24** ○

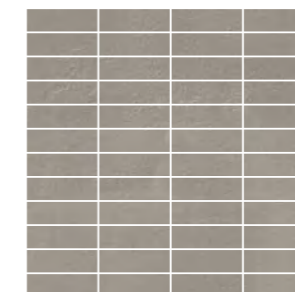

6  
9,80 kg

**041156**  
FACTORY SMOKE MOSAICO 2,5x7,5  
SU RETE 30x30 Cod. **24** ○

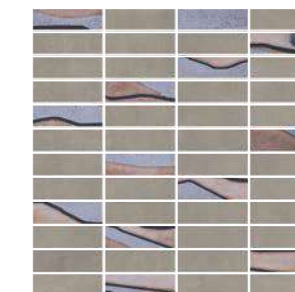

6  
9,80 kg

**041160**  
FACTORY SMOKE MOSAICO METAL 2,5x7,5  
SU RETE 30x30 Cod. **38** ○



(A)  
22  
7,30 kg

**380264**  
FACTORY SMOKE LISTELLO METAL 5x30  
Cod. **4** ○



6  
5,20 kg

**041169**  
FACTORY WHITE/SMOKE  
MOSAICO CITIZEN SU RETE 26,1x26,1  
Cod. **38** ○

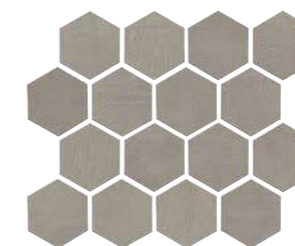

6  
8,80 kg

**041113**  
FACTORY SMOKE  
MOSAICO ESAGONO SU RETE 30x26  
Cod. **128** ○

IMBALLI • PACKAGES • EMBALLAGES • FORMATE

	SCATOLA • BOX • BOITE • KARTON			PALLET • PALLETS • PALETTS • PALETTE		
	pz	mq	kg	box	mq	kg
<b>60x60</b>	3	1,08	23,60	40	43,20	965,00
<b>30x60</b>	6	1,08	26,00	40	43,20	960,00
<b>30x30</b>	11	0,99	21,80	46	45,54	1.025,00
<b>10x30</b>	20	0,60	13,00	60	36,00	800,00
<b>20x20</b>	25	1,00	23,00	51	51,00	1.200,00



**601256**  
FACTORY BLACK RETTIFICATO 60x120  
Cod. **94** □

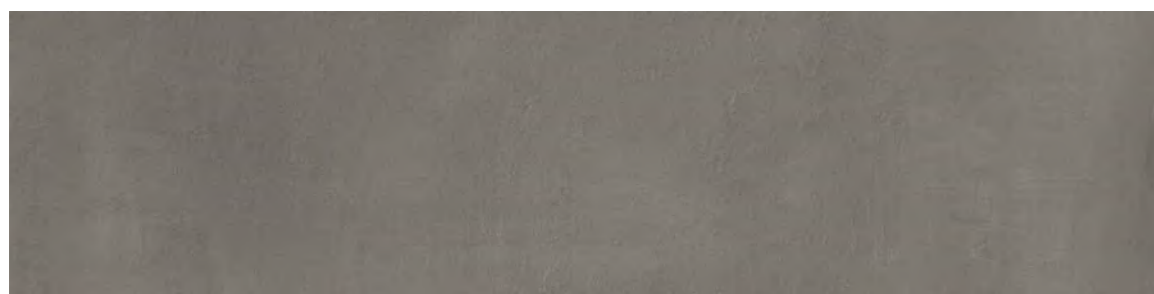

**301251**  
FACTORY BLACK RETTIFICATO 30x120  
Cod. **99** □



**606200**  
FACTORY BLACK RETTIFICATO 60x60  
Cod. **79** □



**490603**  
FACTORY BLACK RETTIFICATO 30x60  
Cod. **76** □



**041110**  
FACTORY BLACK RETTIFICATO 30x30  
Cod. **78** □



**130056**  
FACTORY BLACK RETTIFICATO 20x20  
Cod. **120** □



**103101**  
FACTORY BLACK RETTIFICATO 10x30  
Cod. **77** □



**041170**  
FACTORY WHITE/BLACK  
MOSAICO CITIZEN SU RETE 26,1x26,1  
Cod. **38** ○



5,20 kg

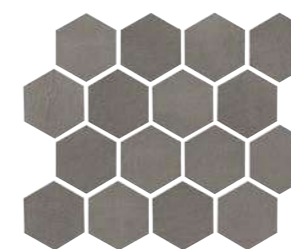

**041114**  
FACTORY BLACK  
MOSAICO ESAGONO SU RETE 30x26  
Cod. **128** ○



8,80 kg

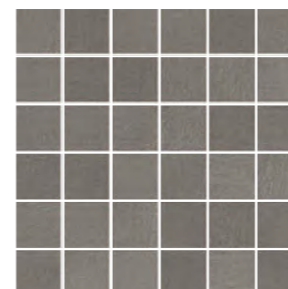

**041118**  
FACTORY BLACK MOSAICO 5x5  
SU RETE 30x30 Cod. **24** ○



10,00 kg

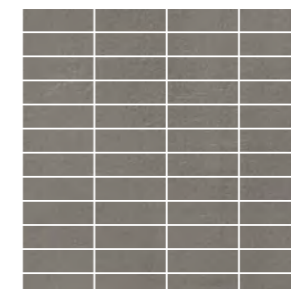

**041157**  
FACTORY BLACK MOSAICO 2,5x7,5  
SU RETE 30x30 Cod. **24** ○



9,80 kg

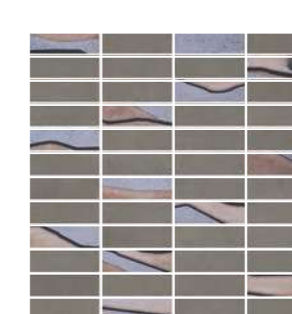

**041161**  
FACTORY BLACK MOSAICO METAL 2,5x7,5  
SU RETE 30x30 Cod. **38** ○



9,80 kg



**380265**  
FACTORY BLACK LISTELLO METAL 5x30  
Cod. **4** ○



7,30 kg

IMBALLI • PACKAGES • EMBALLAGES • FORMATE

	SCATOLA • BOX • BOITE • KARTON			PALLET • PALLETS • PALETTS • PALETTE		
	pz	mq	kg	box	mq	kg
<b>60x120</b>	2	1,44	32,40	30	43,20	978,00
<b>30x120</b>	3	1,08	26,50	42	45,36	1.133,00
<b>60x60</b>	3	1,08	23,60	40	43,20	965,00
<b>30x60</b>	6	1,08	26,00	40	43,20	960,00
<b>30x30</b>	11	0,99	21,80	46	45,54	1.025,00
<b>10x30</b>	20	0,60	13,00	60	36,00	800,00
<b>20x20</b>	25	1,00	23,00	51	51,00	1.200,00

Pezzi speciali • Special trims • Pièces spéciales • Formstücke

Battiscopa



11,60 kg

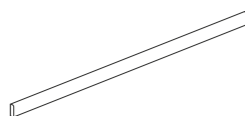

**290715**  
FACTORY WHITE  
BATTISCOPA 5x60  
Cod. 121 △

**290716**  
FACTORY GREY  
BATTISCOPA 5x60  
Cod. 121 △

**290717**  
FACTORY SMOKE  
BATTISCOPA 5x60  
Cod. 121 △

**290718**  
FACTORY BLACK  
BATTISCOPA 5x60  
Cod. 121 △

Gradino



29,40 kg

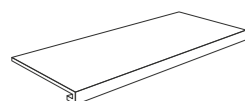

**490618**  
FACTORY WHITE  
GRADINO 33x60  
Cod. 112 ○

**490616**  
FACTORY GREY  
GRADINO 33x60  
Cod. 112 ○

**490617**  
FACTORY SMOKE  
GRADINO 33x60  
Cod. 112 ○

**490615**  
FACTORY BLACK  
GRADINO 33x60  
Cod. 112 ○

Angolare



10,00 kg

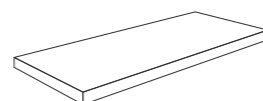

**490626**  
FACTORY WHITE  
ANGOLARE 33x60  
Cod. 107 ○

**490624**  
FACTORY GREY  
ANGOLARE 33x60  
Cod. 107 ○

**490625**  
FACTORY SMOKE  
ANGOLARE 33x60  
Cod. 107 ○

**490623**  
FACTORY BLACK  
ANGOLARE 33x60  
Cod. 107 ○

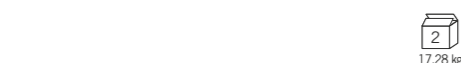

17,28 kg

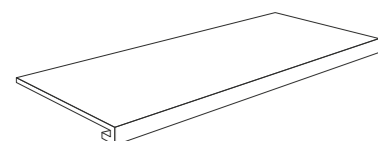

**490622**  
FACTORY WHITE  
GRADINO 33x120  
Cod. 114 ○

**490620**  
FACTORY GREY  
GRADINO 33x120  
Cod. 114 ○

**490621**  
FACTORY SMOKE  
GRADINO 33x120  
Cod. 114 ○

**490619**  
FACTORY BLACK  
GRADINO 33x120  
Cod. 114 ○



20,00 kg

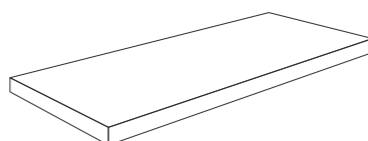

**490630**  
FACTORY WHITE  
ANGOLARE 33x120  
Cod. 110 ○

**490628**  
FACTORY GREY  
ANGOLARE 33x120  
Cod. 110 ○

**490629**  
FACTORY SMOKE  
ANGOLARE 33x120  
Cod. 110 ○

**490627**  
FACTORY BLACK  
ANGOLARE 33x120  
Cod. 110 ○

CARATTERISTICHE DI QUALITÀ Quality characteristics Caractéristiques de qualité Qualitätseigenschaften	NORMA Norm Norme Norme	REQUISITO NORMA Required standards Valeur prescrite selon la norme Normvorgabe	RISULTATO Result Résultat Ergebniss
Assorbimento d'acqua Water absorption of the body Absorption d'eau de support Wasseraufnahme des Scherbens	ISO 10545-3	≤ 0,5	Conforme Conformity Conforme Gemäss
Resistenza a flessione Breaking strenght Résistance à la flexion Biegefestigkeit	ISO 10545-4	≥ 35 N/mm <sup>2</sup>	Conforme Conformity Conforme Gemäss
Resistenza all'abrasione Abrasion resistance Resistance a l'abrasion Abriebbestaendigkeit	ISO 10545-7		PEI V
Resistenza al gelo Frost resistance Résistance au gel Frostbeständigkeit	ISO 10545-12	Nessun campione deve presentare rotture o alterazioni apprezzabili alla superficie No samples must show ruptures or noticeable surface alteration Aucuns enchantions doit présenter ruptures ou altérations appréciables de la surface Keines der Muster sollte Risse oder sichtbare Fehler der Oberfläche zeigen	Conforme Conformity Conforme Gemäss
Resistenza all'attacco chimico Chemical resistance Résistance à l'attaque chimique Beständigkeit gegen chemikalien	ISO 10545-13		GA GLA
Resistenza agli sbalzi termici Thermal shock resistance Resistance aux ecart de température Temperaturwechselbeständigkeit	ISO 10545-5		Conforme Conformity Conforme Gemäss
Resistenza scivolosità Sliding resistance Resistance au glissement Rutschfestigkeit	DIN 51130 R		R10
Resistenza scivolosità Sliding resistance Resistance au glissement Rutschfestigkeit	DIN 51097 (A+B+C)		A+B
Coefficiente d'attrito dinamico Wet dynamic coefficient of friction Coefficient de friction dynamique Reibungskoeffizient Schlüpfriktion (in Bewegung)	Bot 3000 E	DCOF ≥ 0,42	> 0,42
Lieve variazione Slight variation Légère variation Geringe Abweichung			V2

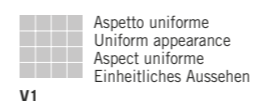

V1

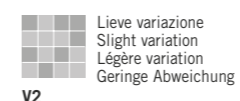

V2

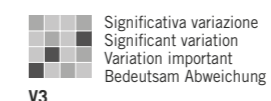

V3

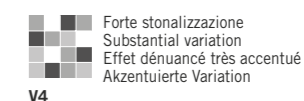

V4

**PER UNA POSA OTTIMALE DEL PRODOTTO CONSIGLIAMO SEMPRE DI MESCOLARE ALMENO TRE SCATOLE DI MATERIALE.**

For the best product laying results, material from at least three boxes should be mixed.

Pour une pose excellente, nous recommandons toujours de mélanger le contenu d'au moins trois boîtes.

Für eine optimale Verlegung des Erzeugnisses empfehlen wir stets, mindestens drei Packungen Material anzumischen.

(A)  
Il prodotto non è resistente agli acidi. Proteggere la superficie del materiale durante le operazioni di posa.  
Non usare abrasivi nella pulizia. Utilizzare detergenti neutri. Per nessun motivo saranno accolte contestazioni sul materiale posato.

Le materiel n'est pas résistant à l'attaque chimique. Protéger la surface du materiel pendant les opérations de pose.  
N'utiliser pas des abrasifs pour nettoyage. Utiliser produits neutres. On pourra pas accepter réclamations sur le materiel posé.

This product has no chemical resistance. Shelter surface of the material during pose operations.  
Don't use abrasive products for cleaning. Use only neutral products. For no reasons we'll accept claim on posed material.

Dieser Artikel ist nicht Laugen- und Säurebeständig. Die Oberfläche während der Verlegearbeiten schuetzen. Keine Schleifmittel fuer die Reinigung benutzen.  
Nur neutrale Reiniger verwenden. Es werden unter keinen Umstaenden Reklamationen NACH der Verlegung akzeptiert.



Tipologia  
Type  
Typologie  
Typ  
Gres porcellanato smaltato  
Glazed porcelain  
Grès cérame emaille  
Feinsteinzeug glasiert

Formati  
Sizes  
Formats  
Formate  
60x120  
60x60  
30x60  
10x30

Spessore  
Thickness  
Épaisseur  
Stärke  
9 mm

Resistenza scivolosità  
Sliding resistance  
Resistance au glissement  
Rutschfestigkeit  
R9

Grado di variazione cromatica  
Degree of colour change  
Degré de variation chromatique  
Grad der Farbabweichung  
V3



**0601320**  
FLORENCE GREY  
RETTIFICATO 60x120  
Cod. **94** □

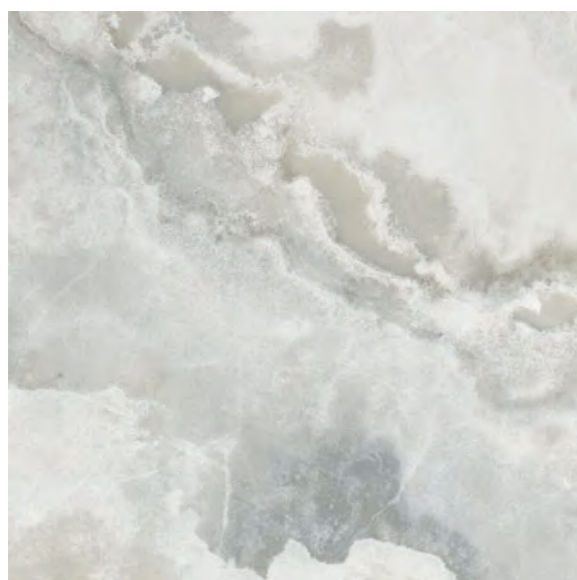

**0606266**  
FLORENCE GREY  
RETTIFICATO 60x60  
Cod. **87** □

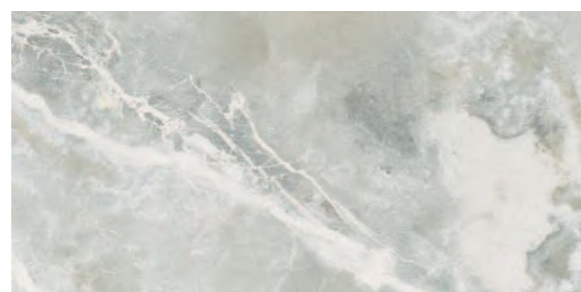

**0490817**  
FLORENCE GREY  
RETTIFICATO 30x60  
Cod. **79** □



**0103147**  
FLORENCE GREY  
RETTIFICATO 10x30  
Cod. **87** □



6  
9,70 kg

**0041419**  
FLORENCE GREY  
MOSAICO 5x5 SU RETE 30x30  
Cod. **26** ○



6  
8,90 kg

**0041427**  
FLORENCE GREY  
MOSAICO ESAGONO SU RETE 27x28  
Cod. **45** ○



6  
9,80 kg

**0041435**  
FLORENCE GREY  
MOSAICO HB SU RETE 28x32  
Cod. **46** ○



6  
9,80 kg

**0041443**  
FLORENCE GREY  
MOSAICO ANTIQUE LUX SU RETE 30x30  
Cod. **69** ○

IMBALLI • PACKAGES • EMBALLAGES • FORMATE

	SCATOLA • BOX • BOITE • KARTON			PALLET • PALLETS • PALETTS • PALETTE		
	<i>pz</i>	<i>mq</i>	<i>kg</i>	<i>box</i>	<i>mq</i>	<i>kg</i>
<b>60x120</b>	2	1,44	33,00	30	43,20	1.010,00
<b>60x60</b>	3	1,08	24,10	40	43,20	980,00
<b>30x60</b>	6	1,08	24,48	40	43,20	980,00
<b>10x30</b>	20	0,60	15,00	60	36,00	920,00





Pezzi speciali • Special trims • Pièces spéciales • Formstücke

Battiscopa

44  
17,20 kg

18  
14,80 kg

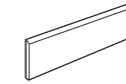

**290835**  
FLORENCE GREY  
BATTISCOPA 7x30  
Cod. **19** △

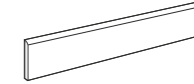

**290843**  
FLORENCE GREY  
BATTISCOPA 7x60  
Cod. **23** △

CARATTERISTICHE DI QUALITÀ Quality characteristics Caractéristiques de qualité Qualitätseigenschaften	NORMA Norm Norme Norme	REQUISITO NORMA Required standards Valeur prescrite selon la norme Normvorgabe	RISULTATO Result Résultat Ergebniss
Assorbimento d'acqua Water absorption of the body Absorption d'eau de support Wasseraufnahme des Scherbens	ISO 10545-3	≤ 0,5	Conforme Conformity Conforme Gemäss
Resistenza a flessione Breaking strenght Résistance à la flexion Biegefestigkeit	ISO 10545-4	≥ 35 N/mm <sup>2</sup>	Conforme Conformity Conforme Gemäss
Resistenza all'abrasione Abrasion resistance Resistance a l'abrasion Abriebbeständigkeit	ISO 10545-7		PEI IV
Resistenza al gelo Frost resistance Résistance au gel Frostbeständigkeit	ISO 10545-12	Nessun campione deve presentare rotture o alterazioni apprezzabili alla superficie No samples must show ruptures or noticeable surface alteration Aucuns enchantions doit présenter ruptures ou altérations appréciables de la surface Keines der Muster sollte Risse oder sichtbare Fehler der Oberfläche zeigen	Conforme Conformity Conforme Gemäss
Resistenza all'attacco chimico Chemical resistance Résistance à l'attaque chimique Beständigkeit gegen chemikalien	ISO 10545-13		GA GLA
Resistenza agli sbalzi termici Thermal shock resistance Resistance aux écarts de température Temperaturwechselbeständigkeit	ISO 10545-5		Conforme Conformity Conforme Gemäss
Resistenza scivolosità Sliding resistance Resistance au glissement Rutschfestigkeit	DIN 51130 R		R9
Coefficiente d'attrito dinamico Wet dynamic coefficient of friction Coefficient de friction dynamique Reibungskoeffizient Schlupfrigkeit (in Bewegung)	Bot 3000 E	DCOF ≥ 0,42	> 0,42
Significativa variazione Significant variation Variation important Bedeutsam Abweichung			V3

Aspetto uniforme  
Uniform appearance  
Aspect uniforme  
Einheitliches Aussehen  
**V1**

Lieve variazione  
Slight variation  
Légère variation  
Geringe Abweichung  
**V2**

Significativa variazione  
Significant variation  
Variation important  
Bedeutsam Abweichung  
**V3**

Forte tonalizzazione  
Substantial variation  
Effet dénuancé très accentué  
Akzentuierte Variation  
**V4**

**PER UNA POSA OTTIMALE DEL PRODOTTO CONSIGLIAMO SEMPRE DI MESCOLARE ALMENO TRE SCATOLE DI MATERIALE.**

For the best product laying results, material from at least three boxes should be mixed.

Pour une pose excellente, nous recommandons toujours de mélanger le contenu d'au moins trois boîtes.

Für eine optimale Verlegung des Erzeugnisses empfehlen wir stets, mindestens drei Packungen Material anzumischen.



Tipologia  
Type  
Typologie  
Typ  
Gres porcellanato smaltato  
Glazed porcelain  
Grès cérame emaille  
Feinsteinzeug glasiert

Formati  
Sizes  
Formats  
Formate  
60x120  
90x90  
60x60  
30x60  
10x30  
25x22 Esagona

Spessore  
Thickness  
Épaisseur  
Stärke  
10 mm

Resistenza scivolosità  
Sliding resistance  
Resistance au glissement  
Rutschfestigkeit  
R10 / A+B  
R11 / A+B+C

Grado di variazione cromatica  
Degree of colour change  
Degré de variation chromatique  
Grad der Farbabweichung  
V3



**909065**  
FLOW GREY RETTIFICATO 90x90  
Cod. **97** □



**601331**  
FLOW GREY RETTIFICATO 60x120  
Cod. **94** □



**606277**  
FLOW GREY RETTIFICATO 60x60  
Cod. **79** □

**606284**  
FLOW GREY RETTIFICATO R11 60x60  
Cod. **83** □



**490827**  
FLOW GREY RETTIFICATO 30x60  
Cod. **76** □



**103157**  
FLOW GREY RETTIFICATO 10x30  
Cod. **77** □



**252220**  
FLOW GREY  
ESAGONA 25x22  
Cod. **85** □



**041454**  
FLOW GREY RETTIFICATO  
MOSAICO 5x5 SU RETE 30x30  
Cod. **24** ○



10,00 kg



**041459**  
FLOW GREY RETTIFICATO  
MOSAICO ESAGONO SU RETE 30x26  
Cod. **128** ○



8,80 kg

IMBALLI • PACKAGES • EMBALLAGES • FORMATE

	SCATOLA • BOX • BOITE • KARTON			PALLET • PALLETS • PALETTS • PALETTE		
	pz	m <sup>q</sup>	kg	box	m <sup>q</sup>	kg
<b>90x90</b>	2	1,62	33,50	20	32,40	670,00
<b>60x120</b>	2	1,44	28,50	32	46,08	912,00
<b>60x60</b>	3	1,08	22,00	40	43,20	880,00
<b>30x60</b>	6	1,08	22,00	40	43,20	880,00
<b>10x30</b>	20	0,60	10,90	60	24,64	654,00
<b>25x22 Esagona</b>	9	0,37	8,10	72	24,64	583,00



**909063**  
FLOW TAUPE RETTIFICATO 90x90  
Cod. **97** □



**601329**  
FLOW TAUPE RETTIFICATO 60x120  
Cod. **94** □



**606275**  
FLOW TAUPE RETTIFICATO 60x60  
Cod. **79** □

**606282**  
FLOW TAUPE RETTIFICATO R11 60x60  
Cod. **83** □



**490825**  
FLOW TAUPE RETTIFICATO 30x60  
Cod. **76** □



**103155**  
FLOW TAUPE RETTIFICATO 10x30  
Cod. **77** □



**252218**  
FLOW TAUPE  
ESAGONA 25x22  
Cod. **85** □



**041452**  
FLOW TAUPE RETTIFICATO  
MOSAICO 5x5 SU RETE 30x30  
Cod. **24** ○



10,00 kg



**041457**  
FLOW TAUPE RETTIFICATO  
MOSAICO ESAGONO SU RETE 30x26  
Cod. **128** ○



8,80 kg

IMBALLI • PACKAGES • EMBALLAGES • FORMATE

	SCATOLA • BOX • BOITE • KARTON			PALLET • PALLETS • PALETTS • PALETTE		
	pz	m <sup>q</sup>	kg	box	m <sup>q</sup>	kg
<b>90x90</b>	2	1,62	33,50	20	32,40	670,00
<b>60x120</b>	2	1,44	28,50	32	46,08	912,00
<b>60x60</b>	3	1,08	22,00	40	43,20	880,00
<b>30x60</b>	6	1,08	22,00	40	43,20	880,00
<b>10x30</b>	20	0,60	10,90	60	24,64	654,00
<b>25x22 Esagona</b>	9	0,37	8,10	72	24,64	583,00



**909064**  
FLOW MUD RETTIFICATO 90x90  
Cod. **97** □



**601330**  
FLOW MUD RETTIFICATO 60x120  
Cod. **94** □



**606276**  
FLOW MUD RETTIFICATO 60x60  
Cod. **79** □

**606283**  
FLOW MUD RETTIFICATO R11 60x60  
Cod. **83** □



**490826**  
FLOW MUD RETTIFICATO 30x60  
Cod. **76** □



**103156**  
FLOW MUD RETTIFICATO 10x30  
Cod. **77** □



**252219**  
FLOW MUD  
ESAGONA 25x22  
Cod. **85** □



**041453**  
FLOW MUD RETTIFICATO  
MOSAICO 5x5 SU RETE 30x30  
Cod. **24** ○



10,00 kg



**041458**  
FLOW MUD RETTIFICATO  
MOSAICO ESAGONO SU RETE 30x26  
Cod. **128** ○



8,80 kg

IMBALLI • PACKAGES • EMBALLAGES • FORMATE

	SCATOLA • BOX • BOITE • KARTON			PALLET • PALLETS • PALETTS • PALETTE		
	pz	mq	kg	box	mq	kg
<b>90x90</b>	2	1,62	33,50	20	32,40	670,00
<b>60x120</b>	2	1,44	28,50	32	46,08	912,00
<b>60x60</b>	3	1,08	22,00	40	43,20	880,00
<b>30x60</b>	6	1,08	22,00	40	43,20	880,00
<b>10x30</b>	20	0,60	10,90	60	24,64	654,00
<b>25x22 Esagona</b>	9	0,37	8,10	72	24,64	583,00



**909062**  
FLOW IVORY RETTIFICATO 90x90  
Cod. **97** □



**601328**  
FLOW IVORY RETTIFICATO 60x120  
Cod. **94** □



**606274**  
FLOW IVORY RETTIFICATO 60x60  
Cod. **79** □

**606281**  
FLOW IVORY RETTIFICATO R11 60x60  
Cod. **83** □



**490824**  
FLOW IVORY RETTIFICATO 30x60  
Cod. **76** □

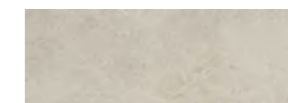

**103154**  
FLOW IVORY RETTIFICATO 10x30  
Cod. **77** □



**252217**  
FLOW IVORY  
ESAGONA 25x22  
Cod. **85** □



**041451**  
FLOW IVORY RETTIFICATO  
MOSAICO 5x5 SU RETE 30x30  
Cod. **24** ○



10,00 kg



**041456**  
FLOW IVORY RETTIFICATO  
MOSAICO ESAGONO SU RETE 30x26  
Cod. **128** ○



8,80 kg

IMBALLI • PACKAGES • EMBALLAGES • FORMATE

	SCATOLA • BOX • BOITE • KARTON			PALLET • PALLETS • PALETTS • PALETTE		
	<i>pz</i>	<i>mq</i>	<i>kg</i>	<i>box</i>	<i>mq</i>	<i>kg</i>
<b>90x90</b>	2	1,62	33,50	20	32,40	670,00
<b>60x120</b>	2	1,44	28,50	32	46,08	912,00
<b>60x60</b>	3	1,08	22,00	40	43,20	880,00
<b>30x60</b>	6	1,08	22,00	40	43,20	880,00
<b>10x30</b>	20	0,60	10,90	60	24,64	654,00
<b>25x22 Esagona</b>	9	0,37	8,10	72	24,64	583,00



**909066**  
FLOW BEIGE RETTIFICATO 90x90  
Cod. **97** □



**601332**  
FLOW BEIGE RETTIFICATO 60x120  
Cod. **94** □



**606278**  
FLOW BEIGE RETTIFICATO 60x60  
Cod. **79** □



**606285**  
FLOW BEIGE RETTIFICATO R11 60x60  
Cod. **83** □



**103158**  
FLOW BEIGE RETTIFICATO 10x30  
Cod. **77** □

**490828**  
FLOW BEIGE RETTIFICATO 30x60  
Cod. **76** □



**252221**  
FLOW BEIGE  
ESAGONA 25x22  
Cod. **85** □



**041455**  
FLOW BEIGE RETTIFICATO  
MOSAICO 5x5 SU RETE 30x30  
Cod. **24** ○



10,00 kg

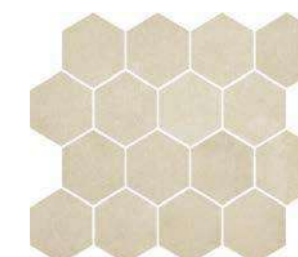

**041460**  
FLOW BEIGE RETTIFICATO  
MOSAICO ESAGONO SU RETE 30x26  
Cod. **128** ○













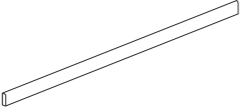
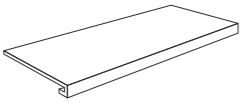
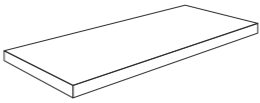

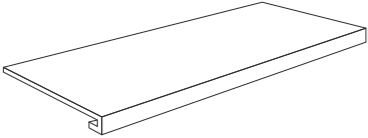
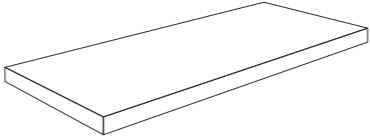

8,80 kg





IMBALLI • PACKAGES • EMBALLAGES • FORMATE

	SCATOLA • BOX • BOITE • KARTON			PALLET • PALLETS • PALETTS • PALETTE		
	pz	mq	kg	box	mq	kg
<b>90x90</b>	2	1,62	33,50	20	32,40	670,00
<b>60x120</b>	2	1,44	28,50	32	46,08	912,00
<b>60x60</b>	3	1,08	22,00	40	43,20	880,00
<b>30x60</b>	6	1,08	22,00	40	43,20	880,00
<b>10x30</b>	20	0,60	10,90	60	24,64	654,00
<b>25x22 Esagona</b>	9	0,37	8,10	72	24,64	583,00

Pezzi speciali • Special trims • Pièces spéciales • Formstücke

Battiscopa		Gradino		Angolare			
	11,60 kg		29,40 kg		10,00 kg		
	<p><b>290858</b> FLOW GREY BATTISCOPA 5x60 Cod. <b>121</b> △</p> <p><b>290856</b> FLOW TAUPE BATTISCOPA 5x60 Cod. <b>121</b> △</p>	<p><b>290857</b> FLOW MUD BATTISCOPA 5x60 Cod. <b>121</b> △</p> <p><b>290855</b> FLOW IVORY BATTISCOPA 5x60 Cod. <b>121</b> △</p>	<p><b>290859</b> FLOW BEIGE BATTISCOPA 5x60 Cod. <b>121</b> △</p>		<p><b>490832</b> FLOW GREY GRADINO 33x60 Cod. <b>112</b> ○</p> <p><b>490830</b> FLOW TAUPE GRADINO 33x60 Cod. <b>112</b> ○</p> <p><b>490831</b> FLOW MUD GRADINO 33x60 Cod. <b>112</b> ○</p> <p><b>490829</b> FLOW IVORY GRADINO 33x60 Cod. <b>112</b> ○</p> <p><b>490833</b> FLOW BEIGE GRADINO 33x60 Cod. <b>112</b> ○</p>		<p><b>490842</b> FLOW GREY ANGOLARE 33x60 Cod. <b>107</b> ○</p> <p><b>490840</b> FLOW TAUPE ANGOLARE 33x60 Cod. <b>107</b> ○</p> <p><b>490841</b> FLOW MUD ANGOLARE 33x60 Cod. <b>107</b> ○</p> <p><b>490839</b> FLOW IVORY ANGOLARE 33x60 Cod. <b>107</b> ○</p> <p><b>490843</b> FLOW BEIGE ANGOLARE 33x60 Cod. <b>107</b> ○</p>
	17,28 kg		20,00 kg				
	<p><b>490837</b> FLOW GREY GRADINO 33x120 Cod. <b>114</b> ○</p> <p><b>490835</b> FLOW TAUPE GRADINO 33x120 Cod. <b>114</b> ○</p> <p><b>490836</b> FLOW MUD GRADINO 33x120 Cod. <b>114</b> ○</p> <p><b>490834</b> FLOW IVORY GRADINO 33x120 Cod. <b>114</b> ○</p> <p><b>490838</b> FLOW BEIGE GRADINO 33x120 Cod. <b>114</b> ○</p>		<p><b>490847</b> FLOW GREY ANGOLARE 33x120 Cod. <b>110</b> ○</p> <p><b>490845</b> FLOW TAUPE ANGOLARE 33x120 Cod. <b>110</b> ○</p> <p><b>490846</b> FLOW MUD ANGOLARE 33x120 Cod. <b>110</b> ○</p> <p><b>490844</b> FLOW IVORY ANGOLARE 33x120 Cod. <b>110</b> ○</p> <p><b>490848</b> FLOW BEIGE ANGOLARE 33x120 Cod. <b>110</b> ○</p>				

CARATTERISTICHE DI QUALITÀ Quality characteristics Caractéristiques de qualité Qualitätseigenschaften	NORMA Norm Norme Norme	REQUISITO NORMA Required standards Valeur prescrite selon la norme Normvorgabe	RISULTATO Result Résultat Ergebniss
 Assorbimento d'acqua Water absorption of the body Absorption d'eau de support Wasseraufnahme des Scherbens	ISO 10545-3	≤ 0,5	Conforme Conformity Conforme Gemäss
 Resistenza a flessione Breaking strenght Résistance à la flexion Biegefestigkeit	ISO 10545-4	≥ 35 N/mm <sup>2</sup>	Conforme Conformity Conforme Gemäss
 Resistenza all'abrasione Abrasion resistance Resistance a l'abrasion Abriebbestaendigkeit	ISO 10545-7		Taupe Mud PEI IV Ivory Beige Grey PEI V
 Resistenza al gelo Frost resistance Résistance au gel Frostbeständigkeit	ISO 10545-12	Nessun campione deve presentare rotture o alterazioni apprezzabili alla superficie No samples must show ruptures or noticeable surface alteration Aucuns enchantions doit présenter ruptures ou altérations appréciables de la surface Keines der Muster sollte Risse oder sichtbare Fehler der Oberflaeche zeigen	Conforme Conformity Conforme Gemäss
 Resistenza all'attacco chimico Chemical resistance Résistance à l'attaque chimique Beständigkeit gegen chemikalien	ISO 10545-13		GA GLA
 Resistenza agli sbalzi termici Thermal shock resistance Resistance aux ecart de température Temperaturwechselbeständigkeit	ISO 10545-5		Conforme Conformity Conforme Gemäss
 Resistenza scivolosità Sliding resistance Resistance au glissement Rutschfestigkeit	DIN 51130 R	FLOW Rettificato FLOW Rettificato R11	R10 R11
 Resistenza scivolosità Sliding resistance Resistance au glissement Rutschfestigkeit	DIN 51097 (A+B+C)	FLOW Rettificato FLOW Rettificato R11	A+B A+B+C
 Coefficiente d'attrito dinamico Wet dynamic coefficient of friction Coefficient de friction dynamique Reibungskoeffizient Schlüfrigkeit (in Bewegung)	Bot 3000 E	DCOF ≥ 0,42	> 0,42
 Significativa variazione Significant variation Variation important Bedeutsam Abweichung			V3

 V1 Aspetto uniforme Uniform appearance Aspect uniforme Einheitliches Aussehen	 V2 Lieve variazione Slight variation Légère variation Geringe Abweichung	 V3 Significativa variazione Significant variation Variation important Bedeutsam Abweichung	 V4 Forte stonizzazione Substantial variation Effet dénuancé très accentué Akzentuierte Variation
---	--	--	--

**PER UNA POSA OTTIMALE DEL PRODOTTO CONSIGLIAMO SEMPRE DI MESCOLARE ALMENO TRE SCATOLE DI MATERIALE.**  
For the best product laying results, material from at least three boxes should be mixed.  
Pour une pose excellente, nous recommandons toujours de mélanger le contenu d'au moins trois boîtes.  
Für eine optimale Verlegung des Erzeugnisses empfehlen wir stets, mindestens drei Packungen Material anzumischen.





Tipologia  
Type  
Typologie  
Typ  
Gres porcellanato smaltato  
Glazed porcelain  
Grès cérame émaillé  
Feinsteinzeug glasiert

Formati  
Sizes  
Formats  
Formate  
60x60  
40x60 + 20x60  
30x60

Spessore  
Thickness  
Épaisseur  
Stärke  
10 mm

Resistenza scivolosità  
Sliding resistance  
Resistance au glissement  
Rutschfestigkeit  
R10 / A+B+C

Grado di variazione cromatica  
Degree of colour change  
Degré de variation chromatique  
Grad der Farbabweichung  
V4



**606226**  
FOSSIL RETTIFICATO 60x60  
Cod. **79** □



**490689**  
FOSSIL RETTIFICATO 30x60  
Cod. **76** □



**406052**  
MIX BOX FOSSIL RETTIFICATO 40x60 + 20x60  
Cod. **89** □



**041296**  
FOSSIL MOSAICO 5x5  
SU RETE 30x30  
Cod. **24** ○



11,30 kg

IMBALLI • PACKAGES • EMBALLAGES • FORMATE

	SCATOLA • BOX • BOITE • KARTON			PALLET • PALLETS • PALETTS • PALETTE		
	pz	mq	kg	box	mq	kg
<b>60x60</b>	3	1,08	23,99	40	43,20	960,00
<b>30x60</b>	6	1,08	23,99	40	43,20	960,00
<b>MIX BOX (40x60 + 20x60)</b>	8 (4+4)	1,44	28,00	22	31,68	650,00

**Battiscopa** 9,00 kg

**290782**  
FOSSIL BATTISCOPA 5x60  
Cod. **121** △

**Gradino** 10,00 kg

**490711**  
FOSSIL GRADINO 33x60  
Cod. **112** ○

**Angolare** 11,00 kg

**490712**  
FOSSIL ANGOLARE 33x60  
Cod. **107** ○

	CARATTERISTICHE DI QUALITÀ Quality characteristics Caractéristiques de qualité Qualitätseigenschaften	NORMA Norm Norme	REQUISITO NORMA Required standards Valeur prescrite selon la norme Normvorgabe	RISULTATO Result Résultat Ergebniss
	Assorbimento d'acqua Water absorption of the body Absorption d'eau de support Wasseraufnahme des Scherbens	ISO 10545-3	≤ 0,5	Conforme Conformity Conforme Gemäss
	Resistenza a flessione Breaking strenght Résistance à la flexion Biegefestigkeit	ISO 10545-4	≥ 35 N/mm <sup>2</sup>	Conforme Conformity Conforme Gemäss
	Resistenza all'abrasione Abrasion resistance Résistance à l'abrasion Abriebbestaendigkeit	ISO 10545-7		PEI V
	Resistenza al gelo Frost resistance Résistance au gel Frostbeständigkeit	ISO 10545-12	Nessun campione deve presentare rotture o alterazioni apprezzabili alla superficie No samples must show ruptures or noticeable surface alteration Aucuns enchantions doit présenter ruptures ou altérations appréciables de la surface Keines der Muster sollte Risse oder sichtbare Fehler der Oberlaeche zeigen	Conforme Conformity Conforme Gemäss
	Resistenza all'attacco chimico Chemical resistance Résistance à l'attaque chimique Beständigkeit gegen chemikalien	ISO 10545-13	Nessun campione deve presentare alterazioni visibili all'attacco chimico No samples must show visible signs of chemical attack Aucuns enchantions doit présenter des altérations visibles à l'attaque chimique Keines der Muster sollte sehenswerte Aenderungen nach Behandlung mit Chemikalien zeigen	Conforme Conformity Conforme Gemäss
	Resistenza agli sbalzi termici Thermal shock resistance Resistance aux ecart de température Temperaturwechselbeständigkeit	ISO 10545-5		Conforme Conformity Conforme Gemäss
	Resistenza scivolosità Sliding resistance Resistance au glissement Rutschfestigkeit	DIN 51130 R		R10
	Resistenza scivolosità Sliding resistance Resistance au glissement Rutschfestigkeit	DIN 51097 (A+B+C)		A+B+C
	Coefficiente d'attrito dinamico Wet dynamic coefficient of friction Coefficient de friction dynamique Reibungskoeffizient Schlupfrigkeit (in Bewegung)	Bot 3000 E	DCOF ≥ 0,42	> 0,42
	Forte stonalizzazione Substantial variation Effet dénuancé très accentué Akzentuierte Variation			V4

**V1** Aspetto uniforme  
Uniform appearance  
Aspect uniforme  
Einheitliches Aussehen

**V2** Lieve variazione  
Slight variation  
Légère variation  
Geringe Abweichung

**V3** Significativa variazione  
Significant variation  
Variation important  
Bedeutsam Abweichung

**V4** Forte stonalizzazione  
Substantial variation  
Effet dénuancé très accentué  
Akzentuierte Variation

**PER UNA POSA OTTIMALE DEL PRODOTTO CONSIGLIAMO SEMPRE DI MESCOLARE ALMENO TRE SCATOLE DI MATERIALE.**  
For the best product laying results, material from at least three boxes should be mixed.  
Pour une pose excellente, nous recommandons toujours de mélanger le contenu d'au moins trois boîtes.  
Für eine optimale Verlegung des Erzeugnisses empfehlen wir stets, mindestens drei Packungen Material anzumischen.



Tipologia  
Type  
Typologie  
Typ  
Gres porcellanato smaltato  
Glazed porcelain  
Grès cérame émaillé  
Feinsteinzeug glasiert

Formati  
Sizes  
Formats  
Formate  
90x90  
45x90  
60x60  
30x60  
30x30  
10x30

Spessore  
Thickness  
Épaisseur  
Stärke  
10 mm

Resistenza scivolosità  
Sliding resistance  
Resistance au glissement  
Rutschfestigkeit  
R10 / A+B

Grado di variazione cromatica  
Degree of colour change  
Degré de variation chromatique  
Grad der Farbabweichung  
V3

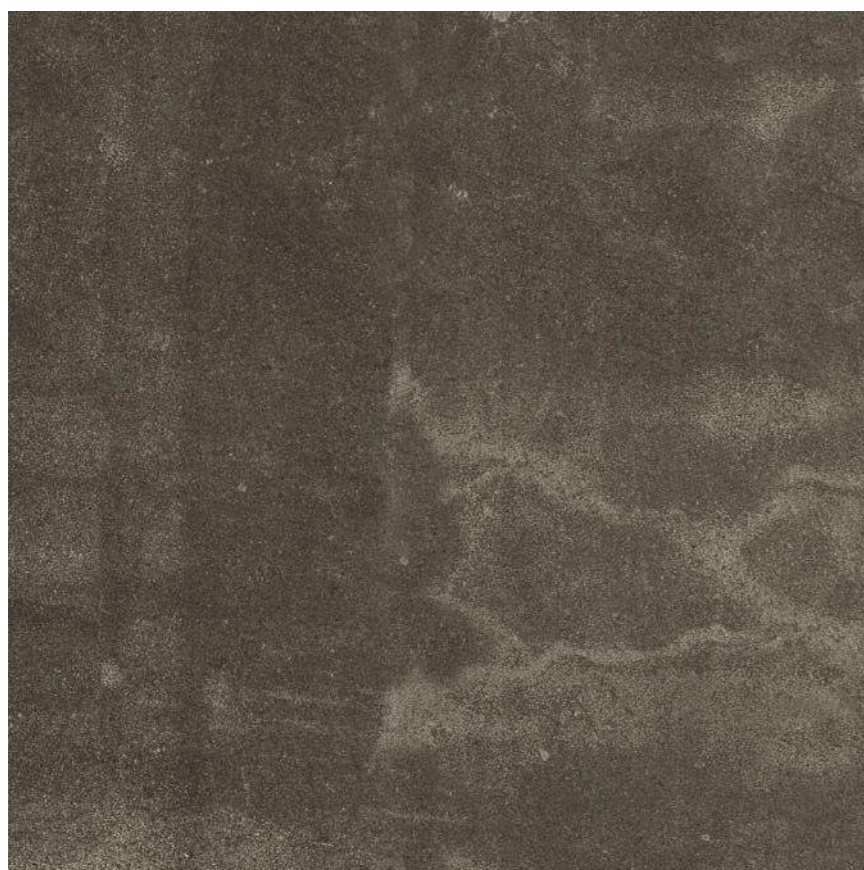

909016  
FUSION ANTRACITE RETTIFICATO 90x90  
Cod. 97 □



459021  
FUSION ANTRACITE RETTIFICATO 45x90  
Cod. 90 □

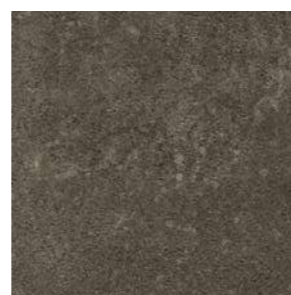

040941  
FUSION ANTRACITE RETTIFICATO 30x30  
Cod. 78 □



103073  
FUSION ANTRACITE RETTIFICATO 10x30  
Cod. 77 □



040958  
FUSION MOSAICO ARABESQUE BLEND  
SU RETE 20x31  
Cod. 38 ○



040957  
FUSION DECO MOSAICO ESAGONO BLEND  
SU RETE 30x26  
Cod. 53 ○



606148  
FUSION ANTRACITE RETTIFICATO 60x60  
Cod. 79 □



490449  
FUSION ANTRACITE RETTIFICATO 30x60  
Cod. 76 □



040946  
FUSION ANTRACITE MOSAICO  
5x5 SU RETE 30x30  
Cod. 24 ○



12,30 kg



040951  
FUSION ANTRACITE FRAME  
2,8x5,8 SU RETE 30x30  
Cod. 28 ○



12,00 kg

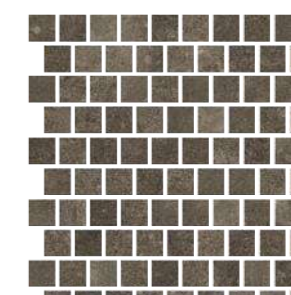

040959  
FUSION ANTRACITE MOSAICO  
MURETTO 3x3 SU RETE 30x33  
Cod. 132 ○



18,50 kg



040956  
FUSION ANTRACITE MULTILEVEL  
7,5x7,5 SU RETE 30x30  
Cod. 43 ○



11,20 kg

IMBALLI • PACKAGES • EMBALLAGES • FORMATE

	SCATOLA • BOX • BOITE • KARTON			PALLET • PALLETS • PALETTS • PALETTE		
	pz	m <sup>2</sup>	kg	box	m <sup>2</sup>	kg
90x90	2	1,62	37,00	18	29,16	690,00
45x90	3	1,22	28,00	32	39,04	894,00
60x60	3	1,08	23,99	40	43,20	960,00
30x60	6	1,08	23,99	40	43,20	960,00
30x30	11	0,99	23,20	46	45,54	1.090,00
10x30	20	0,60	14,00	60	36,00	870,00



909017  
FUSION BEIGE RETTIFICATO 90x90  
Cod. 97 □



459019  
FUSION BEIGE RETTIFICATO 45x90  
Cod. 90 □



040939  
FUSION BEIGE RETTIFICATO 30x30  
Cod. 78 □



103071  
FUSION BEIGE RETTIFICATO 10x30  
Cod. 77 □



040958  
FUSION MOSAICO ARABESQUE BLEND  
SU RETE 20x31  
Cod. 38 ○



040957  
FUSION DECO MOSAICO ESAGONO BLEND  
SU RETE 30x26  
Cod. 53 ○



380212  
FUSION BEIGE LONDON 5X30  
Cod. 33 ○



606149  
FUSION BEIGE RETTIFICATO 60x60  
Cod. 79 □



490450  
FUSION BEIGE RETTIFICATO 30x60  
Cod. 76 □



040944  
FUSION BEIGE MOSAICO  
5x5 SU RETE 30x30  
Cod. 24 ○



12,30 kg



040949  
FUSION BEIGE FRAME  
2,8x5,8 SU RETE 30x30  
Cod. 28 ○



12,00 kg

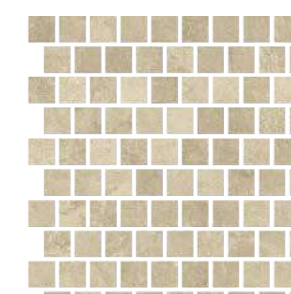

040960  
FUSION BEIGE MOSAICO  
MURETTO 3x3 SU RETE 30x33  
Cod. 132 ○



18,50 kg

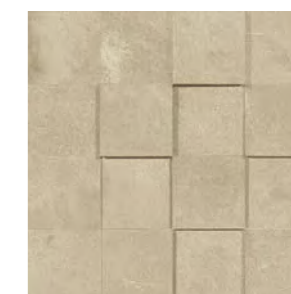

040954  
FUSION BEIGE MULTILEVEL  
7,5x7,5 SU RETE 30x30  
Cod. 43 ○



11,20 kg

IMBALLI • PACKAGES • EMBALLAGES • FORMATE

	SCATOLA • BOX • BOITE • KARTON			PALLET • PALLETS • PALETTS • PALETTE		
	pz	mq	kg	box	mq	kg
90x90	2	1,62	37,00	18	29,16	690,00
45x90	3	1,22	28,00	32	39,04	894,00
60x60	3	1,08	23,99	40	43,20	960,00
30x60	6	1,08	23,99	40	43,20	960,00
30x30	11	0,99	23,20	46	45,54	1.090,00
10x30	20	0,60	14,00	60	36,00	870,00



**909018**  
FUSION BIANCO RETTIFICATO 90x90  
Cod. **97** □



**459020**  
FUSION BIANCO RETTIFICATO 45x90  
Cod. **90** □



**040940**  
FUSION BIANCO RETTIFICATO 30x30  
Cod. **78** □



**103072**  
FUSION BIANCO RETTIFICATO 10x30  
Cod. **77** □



**040958**  
FUSION MOSAICO ARABESQUE BLEND  
SU RETE 20x31  
Cod. **38** ○



**040957**  
FUSION DECO MOSAICO ESAGONO BLEND  
SU RETE 30x26  
Cod. **53** ○



**380213**  
FUSION BIANCO LONDON 5X30  
Cod. **33** ○



**606152**  
FUSION BIANCO RETTIFICATO 60x60  
Cod. **79** □



**490457**  
FUSION BIANCO RETTIFICATO 30x60  
Cod. **76** □



**040945**  
FUSION BIANCO MOSAICO  
5x5 SU RETE 30x30  
Cod. **24** ○



12,30 kg



**040950**  
FUSION BIANCO FRAME  
2,8x5,8 SU RETE 30x30  
Cod. **28** ○



12,00 kg



**040961**  
FUSION BIANCO MOSAICO  
MURETTO 3x3 SU RETE 30x33  
Cod. **132** ○



18,50 kg

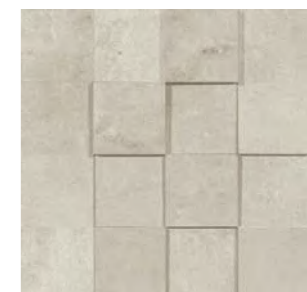

**040955**  
FUSION BIANCO MULTILEVEL  
7,5x7,5 SU RETE 30x30  
Cod. **43** ○



11,20 kg

IMBALLI • PACKAGES • EMBALLAGES • FORMATE

	SCATOLA • BOX • BOITE • KARTON			PALLET • PALLETS • PALETTS • PALETTE		
	pz	m <sup>2</sup>	kg	box	m <sup>2</sup>	kg
<b>90x90</b>	2	1,62	37,00	18	29,16	690,00
<b>45x90</b>	3	1,22	28,00	32	39,04	894,00
<b>60x60</b>	3	1,08	23,99	40	43,20	960,00
<b>30x60</b>	6	1,08	23,99	40	43,20	960,00
<b>30x30</b>	11	0,99	23,20	46	45,54	1.090,00
<b>10x30</b>	20	0,60	14,00	60	36,00	870,00



**909019**  
FUSION GRIGIO RETTIFICATO 90x90  
Cod. **97** □



**459018**  
FUSION GRIGIO RETTIFICATO 45x90  
Cod. **90** □



**040938**  
FUSION GRIGIO RETTIFICATO 30x30  
Cod. **78** □



**103070**  
FUSION GRIGIO RETTIFICATO 10x30  
Cod. **77** □



**040958**  
FUSION MOSAICO ARABESQUE BLEND  
SU RETE 20x31  
Cod. **38** ○



**040957**  
FUSION DECO MOSAICO ESAGONO BLEND  
SU RETE 30x26  
Cod. **53** ○



**380211**  
FUSION GRIGIO LONDON 5X30  
Cod. **33** ○



**606150**  
FUSION GRIGIO RETTIFICATO 60x60  
Cod. **79** □



**490451**  
FUSION GRIGIO RETTIFICATO 30x60  
Cod. **76** □



**040943**  
FUSION GRIGIO MOSAICO  
5x5 SU RETE 30x30  
Cod. **24** ○



12,30 kg

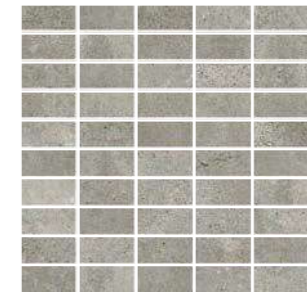

**040948**  
FUSION GRIGIO FRAME  
2,8x5,8 SU RETE 30x30  
Cod. **28** ○



12,00 kg

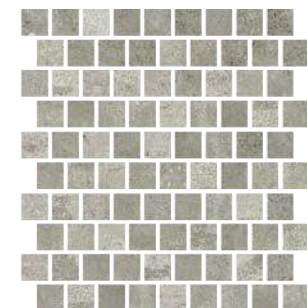

**040962**  
FUSION GRIGIO MOSAICO  
MURETTO 3x3 SU RETE 30x33  
Cod. **132** ○



18,50 kg



**040953**  
FUSION GRIGIO MULTILEVEL  
7,5x7,5 SU RETE 30x30  
Cod. **43** ○



11,20 kg

IMBALLI • PACKAGES • EMBALLAGES • FORMATE

	SCATOLA • BOX • BOITE • KARTON			PALLET • PALLETS • PALETTS • PALETTE		
	pz	m <sup>q</sup>	kg	box	m <sup>q</sup>	kg
<b>90x90</b>	2	1,62	37,00	18	29,16	690,00
<b>45x90</b>	3	1,22	28,00	32	39,04	894,00
<b>60x60</b>	3	1,08	23,99	40	43,20	960,00
<b>30x60</b>	6	1,08	23,99	40	43,20	960,00
<b>30x30</b>	11	0,99	23,20	46	45,54	1.090,00
<b>10x30</b>	20	0,60	14,00	60	36,00	870,00

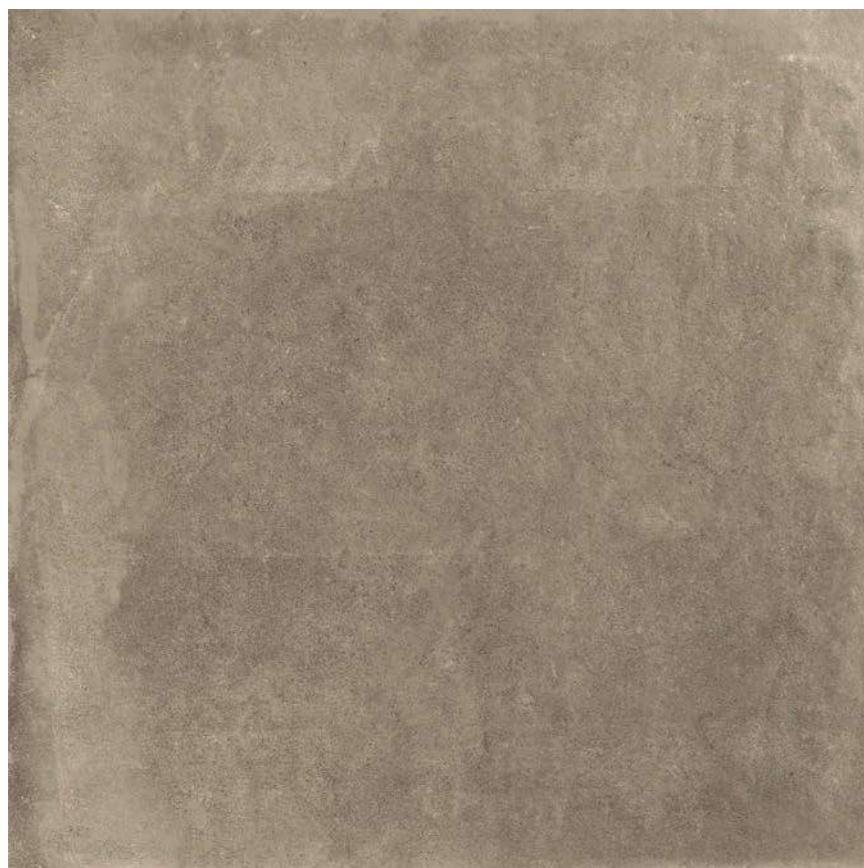

909020  
FUSION TORTORA RETTIFICATO 90x90  
Cod. 97 □



459017  
FUSION TORTORA RETTIFICATO 45x90  
Cod. 90 □



040937  
FUSION TORTORA RETTIFICATO 30x30  
Cod. 78 □



103069  
FUSION TORTORA RETTIFICATO 10x30  
Cod. 77 □



040958  
FUSION MOSAICO ARABESQUE BLEND  
SU RETE 20x31  
Cod. 38 ○



040957  
FUSION DECO MOSAICO ESAGONO BLEND  
SU RETE 30x26  
Cod. 53 ○



380210  
FUSION TORTORA LONDON 5X30  
Cod. 33 ○



606151  
FUSION TORTORA RETTIFICATO 60x60  
Cod. 79 □



490452  
FUSION TORTORA RETTIFICATO 30x60  
Cod. 76 □



040942  
FUSION TORTORA MOSAICO  
5x5 SU RETE 30x30  
Cod. 24 ○



12,30 kg



040947  
FUSION TORTORA FRAME  
2,8x5,8 SU RETE 30x30  
Cod. 28 ○



12,00 kg

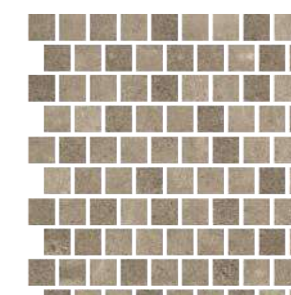

040963  
FUSION TORTORA MOSAICO  
MURETTO 3x3 SU RETE 30x33  
Cod. 132 ○



18,50 kg



040952  
FUSION TORTORA MULTILEVEL  
7,5x7,5 SU RETE 30x30  
Cod. 43 ○



11,20 kg

IMBALLI • PACKAGES • EMBALLAGES • FORMATE

	SCATOLA • BOX • BOITE • KARTON			PALLET • PALLETS • PALETTS • PALETTE		
	pz	m <sup>q</sup>	kg	box	m <sup>q</sup>	kg
90x90	2	1,62	37,00	18	29,16	690,00
45x90	3	1,22	28,00	32	39,04	894,00
60x60	3	1,08	23,99	40	43,20	960,00
30x60	6	1,08	23,99	40	43,20	960,00
30x30	11	0,99	23,20	46	45,54	1.090,00
10x30	20	0,60	14,00	60	36,00	870,00



Pezzi speciali • Special trims • Pièces spéciales • Formstücke

Battiscopa



- 290609**  
FUSION TORTORA BATTISCOPA 5x30  
Cod. **116** △
- 290613**  
FUSION ANTRACITE BATTISCOPA 5x30  
Cod. **116** △
- 290612**  
FUSION BIANCO BATTISCOPA 5x30  
Cod. **116** △
- 290611**  
FUSION BEIGE BATTISCOPA 5x30  
Cod. **116** △
- 290610**  
FUSION GRIGIO BATTISCOPA 5x30  
Cod. **116** △

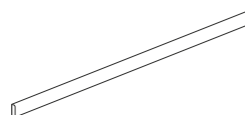

- 290614**  
FUSION TORTORA BATTISCOPA 5x60  
Cod. **121** △
- 290618**  
FUSION ANTRACITE BATTISCOPA 5x60  
Cod. **121** △
- 290617**  
FUSION BIANCO BATTISCOPA 5x60  
Cod. **121** △
- 290616**  
FUSION BEIGE BATTISCOPA 5x60  
Cod. **121** △
- 290615**  
FUSION GRIGIO BATTISCOPA 5x60  
Cod. **121** △

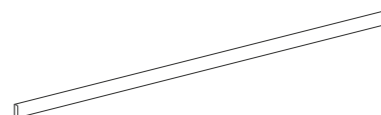

- 290623**  
FUSION TORTORA BATTISCOPA 5x90  
Cod. **33** △
- 290619**  
FUSION ANTRACITE BATTISCOPA 5x90  
Cod. **33** △
- 290621**  
FUSION BIANCO BATTISCOPA 5x90  
Cod. **33** △
- 290620**  
FUSION BEIGE BATTISCOPA 5x90  
Cod. **33** △
- 290622**  
FUSION GRIGIO BATTISCOPA 5x90  
Cod. **33** △

Gradino

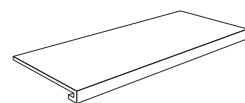

- 490462**  
FUSION TORTORA GRADINO 33x60  
Cod. **112** ○
- 490458**  
FUSION ANTRACITE GRADINO 33x60  
Cod. **112** ○
- 490460**  
FUSION BIANCO GRADINO 33x60  
Cod. **112** ○
- 490459**  
FUSION BEIGE GRADINO 33x60  
Cod. **112** ○
- 490461**  
FUSION GRIGIO GRADINO 33x60  
Cod. **112** ○

Angolare

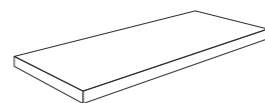

- 490467**  
FUSION TORTORA ANGOLARE 33x60  
Cod. **107** ○
- 490463**  
FUSION ANTRACITE ANGOLARE 33x60  
Cod. **107** ○
- 490465**  
FUSION BIANCO ANGOLARE 33x60  
Cod. **107** ○
- 490464**  
FUSION BEIGE ANGOLARE 33x60  
Cod. **107** ○
- 490466**  
FUSION GRIGIO ANGOLARE 33x60  
Cod. **107** ○

Gradino

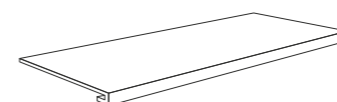

- 490472**  
FUSION TORTORA GRADINO 33x90  
Cod. **114** ○
- 490468**  
FUSION ANTRACITE GRADINO 33x90  
Cod. **114** ○
- 490470**  
FUSION BIANCO GRADINO 33x90  
Cod. **114** ○
- 490469**  
FUSION BEIGE GRADINO 33x90  
Cod. **114** ○
- 490471**  
FUSION GRIGIO GRADINO 33x90  
Cod. **114** ○

Angolare

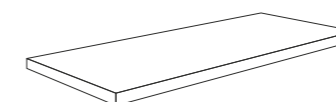

- 490477**  
FUSION TORTORA ANGOLARE 33x90  
Cod. **110** ○
- 490473**  
FUSION ANTRACITE ANGOLARE 33x90  
Cod. **110** ○
- 490475**  
FUSION BIANCO ANGOLARE 33x90  
Cod. **110** ○
- 490474**  
FUSION BEIGE ANGOLARE 33x90  
Cod. **110** ○
- 490476**  
FUSION GRIGIO ANGOLARE 33x90  
Cod. **110** ○

CARATTERISTICHE DI QUALITÀ  
Quality characteristics  
Caractéristiques de qualité  
Qualitätseigenschaften

NORMA  
Norm  
Norme

REQUISITO NORMA  
Required standards  
Valeur prescrite selon la norme  
Normvorgabe

RISULTATO  
Result  
Résultat  
Ergebniss

	Assorbimento d'acqua Water absorption of the body Absorption d'eau de support Wasseraufnahme des Scherbens	ISO 10545-3	≤ 0,5	Conforme Conformity Conforme Gemäss
	Resistenza a flessione Breaking strenght Résistance à la flexion Biegefestigkeit	ISO 10545-4	≥ 35 N/mm <sup>2</sup>	Conforme Conformity Conforme Gemäss
	Resistenza all'abrasione Abrasion resistance Resistance à l'abrasion Abriebbestaendigkeit	ISO 10545-7		PEI V
	Resistenza al gelo Frost resistance Résistance au gel Frostbeständigkeit	ISO 10545-12	Nessun campione deve presentare rotture o alterazioni apprezzabili alla superficie No samples must show ruptures or noticeable surface alteration Aucuns enchantions doit présenter ruptures ou altérations appréciables de la surface Keines der Muster sollte Risse oder sichtbare Fehler der Oberlaeche zeigen	Conforme Conformity Conforme Gemäss
	Resistenza all'attacco chimico Chemical resistance Résistance à l'attaque chimique Beständigkeit gegen chemikalien	ISO 10545-13		GA GLA
	Resistenza agli sbalzi termici Thermal shock resistance Resistance aux écarts de température Temperaturwechselbeständigkeit	ISO 10545-5		Conforme Conformity Conforme Gemäss
	Resistenza scivolosità Sliding resistance Resistance au glissement Rutschfestigkeit	DIN 51130 R		R10
	Resistenza scivolosità Sliding resistance Resistance au glissement Rutschfestigkeit	DIN 51097 (A+B+C)		A+B
	Coefficiente d'attrito dinamico Wet dynamic coefficient of friction Coefficient de friction dynamique Reibungskoeffizient Schlupfrigkeit (in Bewegung)	Bot 3000 E	DCOF ≥ 0,42	> 0,42
	Significativa variazione Significant variation Variation important Bedeutsam Abweichung			V3

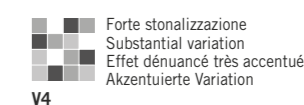
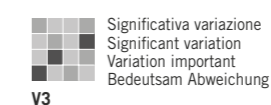
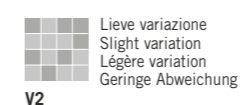
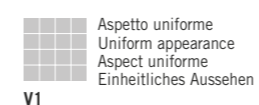

PER UNA POSA OTTIMALE DEL PRODOTTO CONSIGLIAMO SEMPRE DI MESCOLARE ALMENO TRE SCATOLE DI MATERIALE.

For the best product laying results, material from at least three boxes should be mixed.

Pour une pose excellente, nous recommandons toujours de mélanger le contenu d'au moins trois boîtes.

Für eine optimale Verlegung des Erzeugnisses empfehlen wir stets, mindestens drei Packungen Material anzumischen.



Tipologia  
Type  
Typologie  
Typ  
Gres porcellanato smaltato  
Glazed porcelain  
Grès cérame emaille  
Feinsteinzeug glasiert

Formati  
Sizes  
Formats  
Formate  
60x120  
60x60  
30x60  
30x30  
10x30

Spessore  
Thickness  
Épaisseur  
Stärke  
9 mm

Resistenza scivolosità  
Sliding resistance  
Resistance au glissement  
Rutschfestigkeit  
R9

Grado di variazione cromatica  
Degree of colour change  
Degré de variation chromatique  
Grad der Farbabweichung  
V3



**601272**  
ICONIC BLUE NATURALE  
RETTIFICATO 60x120  
Cod. **94** □

**601273**  
ICONIC BLUE LAPPATO  
RETTIFICATO 60x120  
Cod. **103** □



**606217**  
ICONIC BLUE NATURALE  
RETTIFICATO 60x60  
Cod. **79** □

**606218**  
ICONIC BLUE LAPPATO  
RETTIFICATO 60x60  
Cod. **93** □



**490683**  
ICONIC BLUE NATURALE  
RETTIFICATO 30x60  
Cod. **76** □

**490684**  
ICONIC BLUE LAPPATO  
RETTIFICATO 30x60  
Cod. **85** □



**041140**  
ICONIC BLUE NATURALE RETTIFICATO 30x30  
Cod. **78** □

**041141**  
ICONIC BLUE LAPPATO RETTIFICATO 30x30  
Cod. **90** □



**103115**  
ICONIC BLUE NATURALE  
RETTIFICATO 10x30  
Cod. **77** □

**103116**  
ICONIC BLUE LAPPATO  
RETTIFICATO 10x30  
Cod. **93** □



6  
9,30 kg

**041230**  
ICONIC BLUE NATURALE  
MOSAICO 5x5 SU RETE 30x30  
Cod. **24** ○

**041231**  
ICONIC BLUE LAPPATO  
MOSAICO 5x5 SU RETE 30x30  
Cod. **31** ○

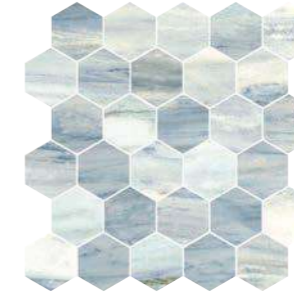

6  
8,90 kg

**041232**  
ICONIC BLUE NATURALE  
MOSAICO ESAGONO SU RETE 27x28  
Cod. **136** ○

**041233**  
ICONIC BLUE LAPPATO  
MOSAICO ESAGONO SU RETE 27x28  
Cod. **49** ○



6  
10,20 kg

**041224**  
ICONIC BLUE NATURALE  
MOSAICO HB SU RETE 28x32  
Cod. **45** ○

**041225**  
ICONIC BLUE LAPPATO  
MOSAICO HB SU RETE 28x32  
Cod. **48** ○



6  
6,50 kg

**041210**  
ICONIC BLUE NATURALE  
MOSAICO ESAGONO INTARSIO SU RETE 20,7x27  
Cod. **57** ○

**041211**  
ICONIC BLUE LAPPATO  
MOSAICO ESAGONO INTARSIO SU RETE 20,7x27  
Cod. **72** ○



10  
3,60 kg

**380295**  
ICONIC BLUE NATURALE  
BORDURA MURETTO 7x30  
Cod. **28** ○

**380296**  
ICONIC BLUE LAPPATO  
BORDURA MURETTO 7x30  
Cod. **28** ○



24  
6,11 kg

**380289**  
ICONIC BLUE NATURALE  
LONDON 5x30  
Cod. **33** ○

**380290**  
ICONIC BLUE LUCIDO  
LONDON 5x30  
Cod. **33** ○

IMBALLI • PACKAGES • EMBALLAGES • FORMATE

	SCATOLA • BOX • BOITE • KARTON			PALLET • PALLETS • PALETTS • PALETTE		
	pz	mq	kg	box	mq	kg
<b>60x120</b>	2	1,44	30,20	30	43,20	906,00
<b>60x60</b>	3	1,08	22,60	40	43,20	904,00
<b>30x60</b>	6	1,08	22,60	40	43,20	904,00
<b>30x30</b>	11	0,99	21,20	46	45,54	975,00
<b>10x30</b>	20	0,60	12,90	60	36,00	774,00



## iconic blue RETT. LAPPATO

La finitura lappata è consigliata per uso rivestimento o per pavimenti da bagno in ambito residenziale. Nello specifico il tipo di pavimentazione deve essere non soggetta ad eccessive sollecitazioni e mai a diretto contatto con aree esterne. Come si verifica comunemente nelle pietre naturali l'eventuale presenza di puntini sulla superficie o di qualche disuniformità della lucentezza sono da considerare caratteristiche del prodotto derivanti dalla lavorazione a cui viene sottoposto.









The polished finish is recommended for wall coverings or for the floors of residential bathrooms. Specifically, floor coverings in this material must not be subjected to excessively heavy traffic and must never be in direct contact with outdoor areas. As is often the case with natural stones, any spots on the surface or any unevenness in shine are typical characteristics of the product, deriving from the process used.

La finitura lappata est recommandée pour le revêtement sol et mur des salles de bains résidentielles. Notamment, ce type de carreau au sol ne doit pas être exposé à des contraintes excessives, et il ne doit jamais être en contact direct avec des zones extérieures. Comme cela est souvent le cas pour les pierres naturelles, les micro trous éventuellement présents à la surface du produit ou l'hétérogénéité de son éclat forment des caractéristiques propres au façonnage.

Die polierte Oberfläche wird für Wandverkleidungen und Bodenbeläge in Privatbädern empfohlen. Der Bodenbelag darf keinen starken Beanspruchungen ausgesetzt sein und keinen direkten Kontakt zu Außenbereichen haben. Wie bei Natursteinen üblich, kann die Oberfläche Körnungen oder einen unregelmäßigen Glanz aufweisen. Diese Merkmale sind typische, beabsichtigte Produkteigenschaften, die durch das Bearbeitungsverfahren hervorgerufen werden.

Pezzi speciali • Special trims • Pièces spéciales • Formstücke

Battiscopa	44 22,40 kg	18 17,10 kg
	<b>290758</b> ICONIC BLUE NATURALE BATTISCOPA 7x30 Cod. <b>116</b> △	<b>290764</b> ICONIC BLUE NATURALE BATTISCOPA 7x60 Cod. <b>121</b> △
	<b>290759</b> ICONIC BLUE LAPPATO BATTISCOPA 7x30 Cod. <b>22</b> △	<b>290765</b> ICONIC BLUE LAPPATO BATTISCOPA 7x60 Cod. <b>26</b> △

CARATTERISTICHE DI QUALITÀ Quality characteristics Caractéristiques de qualité Qualitätseigenschaften	NORMA Norm Norme Norme	REQUISITO NORMA Required standards Valeur prescrite selon la norme Normvorgabe	RISULTATO Result Résultat Ergebnis
 Assorbimento d'acqua Water absorption of the body Absorption d'eau de support Wasseraufnahme des Scherbens	ISO 10545-3	≤ 0,5	Conforme Conformity Conforme Gemäss
 Resistenza a flessione Breaking strength Résistance à la flexion Biegefestigkeit	ISO 10545-4	≥ 35 N/mm <sup>2</sup>	Conforme Conformity Conforme Gemäss
 Resistenza all'abrasione Abrasion resistance Résistance à l'abrasion Abriebbeständigkeit	ISO 10545-7	Iconic Blue Rettificato	PEI IV
 Resistenza al gelo Frost resistance Résistance au gel Frostbeständigkeit	ISO 10545-12	Nessun campione deve presentare rotture o alterazioni apprezzabili alla superficie No samples must show ruptures or noticeable surface alteration Aucuns échantillons doit présenter ruptures ou altérations appréciables de la surface Keines der Muster sollte Risse oder sichtbare Fehler der Oberfläche zeigen	Conforme Conformity Conforme Gemäss
 Resistenza all'attacco chimico Chemical resistance Résistance à l'attaque chimique Beständigkeit gegen chemikalien	ISO 10545-13	Iconic Blue Naturale Iconic Blue Lappato	GA GLA GA GLB
 Resistenza agli sbalzi termici Thermal shock resistance Résistance aux écarts de température Temperaturwechselbeständigkeit	ISO 10545-5		Conforme Conformity Conforme Gemäss
 Resistenza scivolosità Sliding resistance Résistance au glissement Rutschfestigkeit	DIN 51130 R		R9
 Significativa variazione Significant variation Variation important Bedeutsam Abweichung		Iconic Blue Rettificato	V3

 Aspetto uniforme  
Uniform appearance  
Aspect uniforme  
Einheitliches Aussehen  
**V1**

 Lieve variazione  
Slight variation  
Légère variation  
Geringe Abweichung  
**V2**

 Significativa variazione  
Significant variation  
Variation important  
Bedeutsam Abweichung  
**V3**

 Forte stonalizzazione  
Substantial variation  
Effet dénuancé très accentué  
Akzentuierte Variation  
**V4**

**PER UNA POSA OTTIMALE DEL PRODOTTO CONSIGLIAMO SEMPRE DI MESCOLARE ALMENO TRE SCATOLE DI MATERIALE.**

For the best product laying results, material from at least three boxes should be mixed.

Pour une pose excellente, nous recommandons toujours de mélanger le contenu d'au moins trois boîtes.

Für eine optimale Verlegung des Erzeugnisses empfehlen wir stets, mindestens drei Packungen Material anzumischen.



Tipologia  
Type  
Typologie  
Typ  
Gres porcellanato smaltato  
Glazed porcelain  
Grès cérame emaille  
Feinsteinzeug glasiert

Formati  
Sizes  
Formats  
Formate  
60x120  
60x60  
30x60  
10x30

Spessore  
Thickness  
Épaisseur  
Stärke  
9 mm

Resistenza scivolosità  
Sliding resistance  
Resistance au glissement  
Rutschfestigkeit  
R9

Grado di variazione cromatica  
Degree of colour change  
Degré de variation chromatique  
Grad der Farbabweichung  
V3



**601347**  
INDIAN SUNSET NATURALE  
RETTIFICATO 60x120  
Cod. **94** □

**601348**  
INDIAN SUNSET LAPPATO  
RETTIFICATO 60x120  
Cod. **103** □



**606302**  
INDIAN SUNSET NATURALE  
RETTIFICATO 60x60  
Cod. **79** □

**606303**  
INDIAN SUNSET LAPPATO  
RETTIFICATO 60x60  
Cod. **93** □



**490879**  
INDIAN SUNSET NATURALE  
RETTIFICATO 30x60  
Cod. **76** □

**490880**  
INDIAN SUNSET LAPPATO  
RETTIFICATO 30x60  
Cod. **85** □



**103173**  
INDIAN SUNSET NATURALE  
RETTIFICATO 10x30  
Cod. **77** □

**103174**  
INDIAN SUNSET LAPPATO  
RETTIFICATO 10x30  
Cod. **93** □



9,30 kg

**041636**  
INDIAN SUNSET NATURALE  
MOSAICO 5x5 SU RETE 30x30  
Cod. **24** ○

**041637**  
INDIAN SUNSET LAPPATO  
MOSAICO 5x5 SU RETE 30x30  
Cod. **31** ○



8,90 kg

**041553**  
INDIAN SUNSET NATURALE  
MOSAICO ESAGONO SU RETE 27x28  
Cod. **136** ○

**041554**  
INDIAN SUNSET LAPPATO  
MOSAICO ESAGONO SU RETE 27x28  
Cod. **49** ○



10,20 kg

**041521**  
INDIAN SUNSET NATURALE  
MOSAICO HB SU RETE 28x32  
Cod. **45** ○

**041522**  
INDIAN SUNSET LAPPATO  
MOSAICO HB SU RETE 28x32  
Cod. **48** ○



6,50 kg

**041585**  
INDIAN SUNSET NATURALE  
MOSAICO ESAGONO INTARSIO SU RETE 20,7x27  
Cod. **57** ○

**041586**  
INDIAN SUNSET LAPPATO  
MOSAICO ESAGONO INTARSIO SU RETE 20,7x27  
Cod. **72** ○



8,50 kg

**041569**  
INDIAN SUNSET NATURALE  
MOSAICO FANCY SU RETE 24x30  
Cod. **51** ○

**041570**  
INDIAN SUNSET LAPPATO  
MOSAICO FANCY SU RETE 24x30  
Cod. **71** ○

**IMBALLI • PACKAGES • EMBALLAGES • FORMATE**

	SCATOLA • BOX • BOITE • KARTON			PALLET • PALLETS • PALETTS • PALETTE		
	pz	mq	kg	box	mq	kg
<b>60x120</b>	2	1,44	30,20	30	43,20	906,00
<b>60x60</b>	3	1,08	22,60	40	43,20	904,00
<b>30x60</b>	6	1,08	22,60	40	43,20	904,00
<b>10x30</b>	20	0,60	12,90	60	36,00	774,00



## indian sunset RETT. LAPPATO

La finitura lappata è consigliata per uso rivestimento o per pavimenti da bagno in ambito residenziale. Nello specifico il tipo di pavimentazione deve essere non soggetta ad eccessive sollecitazioni e mai a diretto contatto con aree esterne. Come si verifica comunemente nelle pietre naturali l'eventuale presenza di puntini sulla superficie o di qualche disuniformità della lucentezza sono da considerare caratteristiche del prodotto derivanti dalla lavorazione a cui viene sottoposto.

The polished finish is recommended for wall coverings or for the floors of residential bathrooms. Specifically, floor coverings in this material must not be subjected to excessively heavy traffic and must never be in direct contact with outdoor areas. As is often the case with natural stones, any spots on the surface or any unevenness in shine are typical characteristics of the product, deriving from the process used.

La finitura lappata est recommandée pour le revêtement sol et mur des salles de bains résidentielles. Notamment, ce type de carreau au sol ne doit pas être exposé à des contraintes excessives, et il ne doit jamais être en contact direct avec des zones extérieures. Comme cela est souvent le cas pour les pierres naturelles, les micro trous éventuellement présents à la surface du produit ou l'hétérogénéité de son éclat forment des caractéristiques propres au façonnage.

Die polierte Oberfläche wird für Wandverkleidungen und Bodenbeläge in Privatbädern empfohlen. Der Bodenbelag darf keinen starken Beanspruchungen ausgesetzt sein und keinen direkten Kontakt zu Außenbereichen haben. Wie bei Natursteinen üblich, kann die Oberfläche Körnungen oder einen unregelmäßigen Glanz aufweisen. Diese Merkmale sind typische, beabsichtigte Produkteigenschaften, die durch das Bearbeitungsverfahren hervorgerufen werden.

Pezzi speciali • Special trims • Pièces spéciales • Formstücke

Battiscopa

44  
22,40 kg

18  
17,10 kg

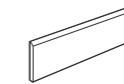

**290890**  
INDIAN SUNSET NATURALE  
BATTISCOPA 7x30  
Cod. **116** △

**290891**  
INDIAN SUNSET LAPPATO  
BATTISCOPA 7x30  
Cod. **22** △

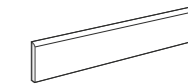

**290906**  
INDIAN SUNSET NATURALE  
BATTISCOPA 7x60  
Cod. **121** △

**290907**  
INDIAN SUNSET LAPPATO  
BATTISCOPA 7x60  
Cod. **26** △

CARATTERISTICHE DI QUALITÀ Quality characteristics Caractéristiques de qualité Qualitätseigenschaften	NORMA Norm Norme Norme	REQUISITO NORMA Required standards Valeur prescrite selon la norme Normvorgabe	RISULTATO Result Résultat Ergebnis
Assorbimento d'acqua Water absorption of the body Absorption d'eau de support Wasseraufnahme des Scherbens	ISO 10545-3	≤ 0,5	Conforme Conformity Conforme Gemäss
Resistenza a flessione Breaking strenght Résistance à la flexion Biegefestigkeit	ISO 10545-4	≥ 35 N/mm <sup>2</sup>	Conforme Conformity Conforme Gemäss
Resistenza all'abrasione Abrasion resistance Résistance à l'abrasion Abriebbeständigkeit	ISO 10545-7	INDIAN SUNSET Rettificato	PEI IV
Resistenza al gelo Frost resistance Résistance au gel Frostbeständigkeit	ISO 10545-12	Nessun campione deve presentare rotture o alterazioni apprezzabili alla superficie No samples must show ruptures or noticeable surface alteration Aucuns enchantions doit présenter ruptures ou altérations appréciables de la surface Keines der Muster sollte Risse oder sichtbare Fehler der Oberfläche zeigen	Conforme Conformity Conforme Gemäss
Resistenza all'attacco chimico Chemical resistance Résistance à l'attaque chimique Beständigkeit gegen chemikalien	ISO 10545-13	INDIAN SUNSET Naturale INDIAN SUNSET Lappato	GA GLA GA GLB
Resistenza agli sbalzi termici Thermal shock resistance Résistance aux écarts de température Temperaturwechselbeständigkeit	ISO 10545-5		Conforme Conformity Conforme Gemäss
Resistenza scivolosità Sliding resistance Résistance au glissement Rutschfestigkeit	DIN 51130 R		R9
Significativa variazione Significant variation Variation important Bedeutsam Abweichung		INDIAN SUNSET Rettificato	V3

Aspetto uniforme  
Uniform appearance  
Aspect uniforme  
Einheitliches Aussehen  
**V1**

Lieve variazione  
Slight variation  
Légère variation  
Geringe Abweichung  
**V2**

Significativa variazione  
Significant variation  
Variation important  
Bedeutsam Abweichung  
**V3**

Forte tonalizzazione  
Substantial variation  
Effet dénuancé très accentué  
Akzentuierte Variation  
**V4**

**PER UNA POSA OTTIMALE DEL PRODOTTO CONSIGLIAMO SEMPRE DI MESCOLARE ALMENO TRE SCATOLE DI MATERIALE.**

For the best product laying results, material from at least three boxes should be mixed.

Pour une pose excellente, nous recommandons toujours de mélanger le contenu d'au moins trois boîtes.

Für eine optimale Verlegung des Erzeugnisses empfehlen wir stets, mindestens drei Packungen Material anzumischen.



Tipologia  
Type  
Typologie  
Typ  
Gres porcellanato smaltato  
Glazed porcelain  
Grès cérame emaille  
Feinsteinzeug glasiert

Formati R10  
Sizes  
Formats  
Formate  
90x90  
60x90  
30x60  
7,5x30  
MIX BOX

Formati R11 A - B - C  
Sizes  
Formats  
Formate  
90x90 (20 mm)  
60x90 (10 mm)

Spessore  
Thickness  
Épaisseur  
Stärke  
10 mm  
20 mm

Resistenza scivolosità  
Sliding resistance  
Résistance au glissement  
Rutschfestigkeit  
R10 / A+B  
R11 / A+B+C

Grado di variazione cromatica  
Degree of colour change  
Degré de variation chromatique  
Grad der Farbabweichung  
V3





**909048**  
LA RÉSERVE BEIGE  
RETTIFICATO 90x90  
Cod. **97** □



**490813**  
LA RÉSERVE BEIGE  
RETTIFICATO 30x60  
Cod. **76** □



**753014**  
LA RÉSERVE BEIGE  
RETTIFICATO 7,5x30  
Cod. **97** □



**609000**  
LA RÉSERVE BEIGE  
RETTIFICATO 60x90  
Cod. **79** □

**609006**  
LA RÉSERVE BEIGE  
RETTIFICATO **R11** 60x90  
Cod. **80** □



**041409**  
LA RÉSERVE BEIGE  
MOSAICO 5x5 SU RETE 30x30  
Cod. **31** ○



**041412**  
LA RÉSERVE BEIGE  
MOSAICO ESAGONO SU RETE 34,5x30  
Cod. **45** ○



**909049**  
LA RÉSERVE GREIGE  
RETTIFICATO 90x90  
Cod. **97** □



**490814**  
LA RÉSERVE GREIGE  
RETTIFICATO 30x60  
Cod. **76** □



**753015**  
LA RÉSERVE GREIGE  
RETTIFICATO 7,5x30  
Cod. **97** □



**609001**  
LA RÉSERVE GREIGE  
RETTIFICATO 60x90  
Cod. **79** □

**609007**  
LA RÉSERVE GREIGE  
RETTIFICATO **R11** 60x90  
Cod. **80** □



**041410**  
LA RÉSERVE GREIGE  
MOSAICO 5x5 SU RETE 30x30  
Cod. **31** ○



**041413**  
LA RÉSERVE GREIGE  
MOSAICO ESAGONO SU RETE 34,5x30  
Cod. **45** ○



IMBALLI • PACKAGES • EMBALLAGES • FORMATE

	SCATOLA • BOX • BOITE • KARTON			PALLET • PALLETS • PALETTS • PALETTE		
	pz	m <sup>q</sup>	kg	box	m <sup>q</sup>	kg
<b>90x90</b>	2	1,62	33,5	20	32,40	670,00
<b>60x90</b>	2	1,08	21,70	48	51,84	1.040,00
<b>30x60</b>	6	1,08	20,90	40	43,20	836,00
<b>7,5x30</b>	32	0,72	15,00	68	48,96	1.000,00

IMBALLI • PACKAGES • EMBALLAGES • FORMATE

	SCATOLA • BOX • BOITE • KARTON			PALLET • PALLETS • PALETTS • PALETTE		
	pz	m <sup>q</sup>	kg	box	m <sup>q</sup>	kg
<b>90x90</b>	2	1,62	33,5	20	32,40	670,00
<b>60x90</b>	2	1,08	21,70	48	51,84	1.040,00
<b>30x60</b>	6	1,08	20,90	40	43,20	836,00
<b>7,5x30</b>	32	0,72	15,00	68	48,96	1.000,00



**909050**  
LA RÉSERVE IVOIRE  
RETTIFICATO 90x90  
Cod. **97** □



**490815**  
LA RÉSERVE IVOIRE  
RETTIFICATO 30x60  
Cod. **76** □

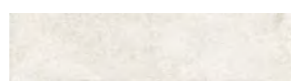

**753016**  
LA RÉSERVE IVOIRE  
RETTIFICATO 7,5x30  
Cod. **97** □



6  
9,12 kg

**041411**  
LA RÉSERVE IVOIRE  
MOSAICO 5x5 SU RETE 30x30  
Cod. **31** ○



6  
12,20 kg

**041414**  
LA RÉSERVE IVOIRE  
MOSAICO ESAGONO SU RETE 34,5x30  
Cod. **45** ○

**609002**  
LA RÉSERVE IVOIRE  
RETTIFICATO 60x90  
Cod. **79** □

**609008**  
LA RÉSERVE IVOIRE  
RETTIFICATO R11 60x90  
Cod. **80** □

IMBALLI • PACKAGES • EMBALLAGES • FORMATE

	SCATOLA • BOX • BOITE • KARTON			PALLET • PALLETS • PALETTS • PALETTE		
	pz	m <sup>q</sup>	kg	box	m <sup>q</sup>	kg
<b>90x90</b>	2	1,62	33,5	20	32,40	670,00
<b>60x90</b>	2	1,08	21,70	48	51,84	1.040,00
<b>30x60</b>	6	1,08	20,90	40	43,20	836,00
<b>7,5x30</b>	32	0,72	15,00	68	48,96	1.000,00



**909059**  
LA RÉSERVE BEIGE 2 CM 90x90 RETTIFICATO R11  
Cod. **141** □

20 mm



**909060**  
LA RÉSERVE GREIGE 2 CM 90x90 RETTIFICATO R11  
Cod. **141** □

20 mm



**909061**  
LA RÉSERVE IVOIRE 2 CM 90x90 RETTIFICATO R11  
Cod. **141** □

20 mm

IMBALLI • PACKAGES • EMBALLAGES • FORMATE

	SCATOLA • BOX • BOITE • KARTON			PALLET • PALLETS • PALETTS • PALETTE		
	pz	m <sup>q</sup>	kg	box	m <sup>q</sup>	kg
<b>90x90 (20mm)</b>	1	0,81	34,80	21	17,01	731,00

Suggerimenti di posa • Laying proposals • Solutions de pose • Verlegevorschläge

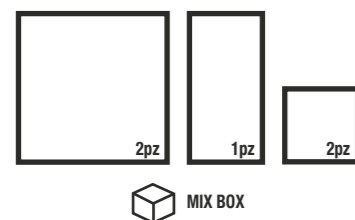

**609003**  
LA RÉSERVE BEIGE RETTIFICATO  
MIX BOX  
60x60 - 30x60 - 30x30  
Cod. **98** □

**609005**  
LA RÉSERVE IVOIRE RETTIFICATO  
MIX BOX  
60x60 - 30x60 - 30x30  
Cod. **98** □

**609004**  
LA RÉSERVE GREIGE RETTIFICATO  
MIX BOX  
60x60 - 30x60 - 30x30  
Cod. **98** □

IMBALLI • PACKAGES • EMBALLAGES • FORMATE

	SCATOLA • BOX • BOITE • KARTON			PALLET • PALLETS • PALETTES • PALETTE		
	pz	mq	kg	box	mq	kg
MIX BOX	5	1,08	20,90	48	51,84	1.010,00

Suggerimenti di posa • Laying proposals • Solutions de pose • Verlegevorschläge

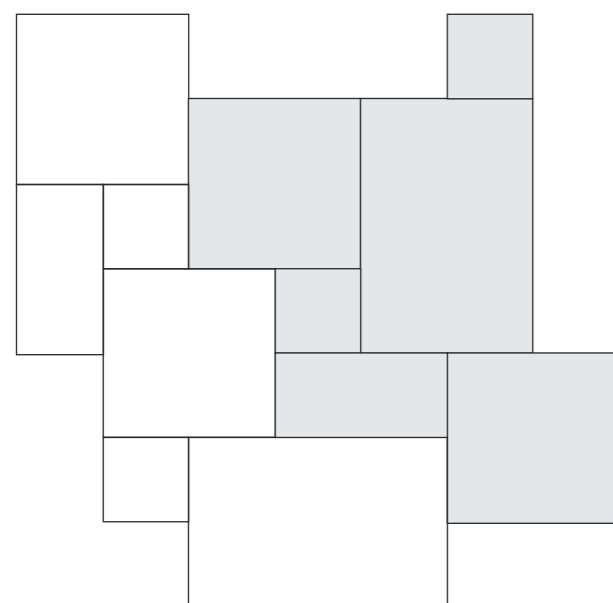

**600167**  
LA RÉSERVE BEIGE RETTIFICATO  
COMPO  
60x90 - 60x60 - 30x60 - 30x30  
Cod. **96** □

**600169**  
LA RÉSERVE IVOIRE RETTIFICATO  
COMPO  
60x90 - 60x60 - 30x60 - 30x30  
Cod. **96** □

**600168**  
LA RÉSERVE GREIGE RETTIFICATO  
COMPO  
60x90 - 60x60 - 30x60 - 30x30  
Cod. **96** □

60 x 90 .....33,33 %      30 x 60 .....11,11 %  
60 x 60 .....44,44 %      30 x 30 .....11,11 %

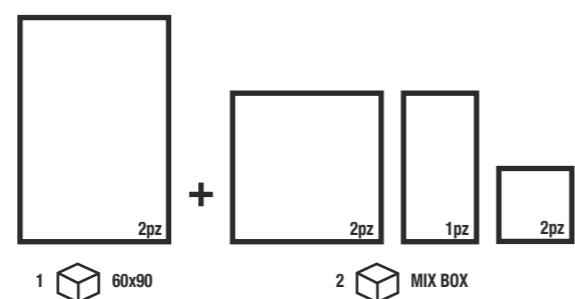

Pezzi speciali • Special trims • Pièces spéciales • Formstücke

Battiscopa



**290831**  
LA RÉSERVE BEIGE RETTIFICATO  
BATTISCOPA 5x60  
Cod. **121** △

**290832**  
LA RÉSERVE GREIGE RETTIFICATO  
BATTISCOPA 5x60  
Cod. **121** △

**290833**  
LA RÉSERVE IVOIRE RETTIFICATO  
BATTISCOPA 5x60  
Cod. **121** △

CARATTERISTICHE DI QUALITÀ Quality characteristics Caractéristiques de qualité Qualitätseigenschaften	NORMA Norm Norme Norme	REQUISITO NORMA Required standards Valeur prescrite selon la norme Normvorgabe	RISULTATO Result Résultat Ergebniss
Assorbimento d'acqua Water absorption of the body Absorption d'eau de support Wasseraufnahme des Scherbens	ISO 10545-3	≤ 0,5	Conforme Conformity Conforme Gemäss
Resistenza a flessione Breaking strenght Résistance à la flexion Biegefestigkeit	ISO 10545-4	≥ 35 N/mm <sup>2</sup>	Conforme Conformity Conforme Gemäss
Resistenza all'abrasione Abrasion resistance Resistance a l'abrasion Abriebbeständigkeit	EN ISO 10545-7		PEI V
Resistenza al gelo Frost resistance Résistance au gel Frostbeständigkeit	ISO 10545-12	Nessun campione deve presentare rotture o alterazioni apprezzabili alla superficie No samples must show ruptures or noticeable surface alteration Aucuns enchantions doit présenter ruptures ou altérations appréciables de la surface Keines der Muster sollte Risse oder sichtbare Fehler der Oberflaeche zeigen	Conforme Conformity Conforme Gemäss
Resistenza all'attacco chimico Chemical resistance Résistance à l'attaque chimique Beständigkeit gegen chemikalien	ISO 10545-13		GA GLA
Resistenza agli sbalzi termici Thermal shock resistance Resistance aux ecart de température Temperaturwechselbeständigkeit	ISO 10545-5		Conforme Conformity Conforme Gemäss
Resistenza scivolosità Sliding resistance Resistance au glissement Rutschfestigkeit	DIN 51130 R	La Réserve La Réserve R11 - La Réserve 20 mm	R10 R11
Resistenza scivolosità Sliding resistance Resistance au glissement Rutschfestigkeit	DIN 51097 (A+B+C)	La Réserve La Réserve R11 - La Réserve 20 mm	A+B A+B+C
Coefficiente d'attrito dinamico Wet dynamic coefficient of friction Coefficient de friction dynamique Reibungskoeffizient Schliüprigkeit (in Bewegung)	Bot 3000 E	DCOF ≥ 0,42	> 0,42
Significativa variazione Significant variation Variation important Bedeutsam Abweichung			V3

V1 Aspetto uniforme Uniform appearance Aspect uniforme Einheitliches Aussehen	V2 Lieve variazione Slight variation Légère variation Geringe Abweichung	V3 Significativa variazione Significant variation Variation important Bedeutsam Abweichung	V4 Forte stonizzazione Substantial variation Effet dénuancé très accentué Akzentuierte Variation
---	--	--	--

PER UNA POSA OTTIMALE DEL PRODOTTO CONSIGLIAMO SEMPRE DI MESCOLARE ALMENO TRE SCATOLE DI MATERIALE.

For the best product laying results, material from at least three boxes should be mixed.

Pour une pose excellente, nous recommandons toujours de mélanger le contenu d'au moins trois boîtes.

Für eine optimale Verlegung des Erzeugnisses empfehlen wir stets, mindestens drei Packungen Material anzumischen.



Tipologia  
Type  
Typologie  
Typ  
Gres porcellanato smaltato  
Glazed porcelain  
Grès cérame emaille  
Feinsteinzeug glasiert

Formati R10  
Sizes  
Formats  
Formate  
90x90  
60x90  
60x60  
30x60  
40x60  
40x40  
20x40  
20x20  
7,5x30  
MIX BOX

Spessore  
Thickness  
Épaisseur  
Stärke  
10 mm

Resistenza scivolosità  
Sliding resistance  
Resistance au glissement  
Rutschfestigkeit  
R10 / A+B  
R11 / A+B+C

Grado di variazione cromatica  
Degree of colour change  
Degré de variation chromatique  
Grad der Farbabweichung  
V3



**909075**  
LAVA STONE SHADOW  
RETTIFICATO 90x90  
Cod. **97** □



**609033**  
LAVA STONE SHADOW  
RETTIFICATO 60x90  
Cod. **83** □



**406072**  
LAVA STONE SHADOW  
RETTIFICATO 40x60  
Cod. **70** □



**404022**  
LAVA STONE SHADOW  
RETTIFICATO 40x40  
Cod. **71** □



**130096**  
LAVA STONE SHADOW  
RETTIFICATO 20x20  
Cod. **96** □



**753022**  
LAVA STONE SHADOW  
RETTIFICATO 7,5x30  
Cod. **81** □



**606312**  
LAVA STONE SHADOW  
RETTIFICATO 60x60  
Cod. **79** □



**490898**  
LAVA STONE SHADOW  
RETTIFICATO 30x60  
Cod. **76** □



**204017**  
LAVA STONE SHADOW  
RETTIFICATO 20x40  
Cod. **78** □



**130092**  
LAVA STONE SHADOW  
DECORATO RETTIFICATO 20x20  
Cod. **104** □



**041618**  
LAVA STONE SHADOW  
MOSAICO 5x5 SU RETE 30x30  
Cod. **27** ○



9,12 kg



**041622**  
LAVA STONE SHADOW  
MOSAICO ESAGONO SU RETE 34,7x30  
Cod. **43** ○



12,20 kg

IMBALLI • PACKAGES • EMBALLAGES • FORMATE

	SCATOLA • BOX • BOITE • KARTON			PALLET • PALLETS • PALETTS • PALETTE		
	pz	mq	kg	box	mq	kg
<b>90x90</b>	2	1,62	31,90	20	32,40	638,00
<b>60x90</b>	2	1,08	21,70	48	51,84	1.042,00
<b>60x60</b>	3	1,08	20,60	40	43,20	824,00
<b>30x60</b>	6	1,08	20,00	40	43,20	800,00
<b>40x60</b>	4	0,96	19,20	48	46,08	921,00
<b>40x40</b>	6	0,96	19,20	60	57,60	1.152,00
<b>20x40</b>	8	0,64	13,70	72	46,08	986,00
<b>20x20</b>	16	0,64	13,70	72	46,08	986,00
<b>7,5x30</b>	32	0,72	15,00	68	48,96	1.020,00



**909076**  
LAVA STONE IVORY  
RETTIFICATO 90x90  
Cod. **97** □



**609034**  
LAVA STONE IVORY  
RETTIFICATO 60x90  
Cod. **83** □



**406073**  
LAVA STONE IVORY  
RETTIFICATO 40x60  
Cod. **70** □



**404023**  
LAVA STONE IVORY  
RETTIFICATO 40x40  
Cod. **71** □

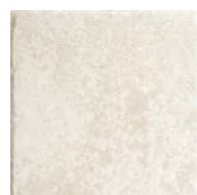

**130097**  
LAVA STONE IVORY  
RETTIFICATO 20x20  
Cod. **96** □



**753023**  
LAVA STONE IVORY  
RETTIFICATO 7,5x30  
Cod. **81** □



**606313**  
LAVA STONE IVORY  
RETTIFICATO 60x60  
Cod. **79** □



**490899**  
LAVA STONE IVORY  
RETTIFICATO 30x60  
Cod. **76** □



**204018**  
LAVA STONE IVORY  
RETTIFICATO 20x40  
Cod. **78** □



**130093**  
LAVA STONE IVORY  
DECORATO RETTIFICATO 20x20  
Cod. **104** □



6  
9,12 kg

**041619**  
LAVA STONE IVORY  
MOSAICO 5x5 SU RETE 30x30  
Cod. **27** ○



6  
12,20 kg

**041623**  
LAVA STONE IVORY  
MOSAICO ESAGONO SU RETE 34,7x30  
Cod. **43** ○

IMBALLI • PACKAGES • EMBALLAGES • FORMATE

	SCATOLA • BOX • BOITE • KARTON			PALLET • PALLETS • PALETTS • PALETTE		
	pz	m <sup>q</sup>	kg	box	m <sup>q</sup>	kg
<b>90x90</b>	2	1,62	31,90	20	32,40	638,00
<b>60x90</b>	2	1,08	21,70	48	51,84	1.042,00
<b>60x60</b>	3	1,08	20,60	40	43,20	824,00
<b>30x60</b>	6	1,08	20,00	40	43,20	800,00
<b>40x60</b>	4	0,96	19,20	48	46,08	921,00
<b>40x40</b>	6	0,96	19,20	60	57,60	1.152,00
<b>20x40</b>	8	0,64	13,70	72	46,08	986,00
<b>20x20</b>	16	0,64	13,70	72	46,08	986,00
<b>7,5x30</b>	32	0,72	15,00	68	48,96	1.020,00



**909077**  
LAVA STONE BLACK  
RETTIFICATO 90x90  
Cod. **97** □



**609035**  
LAVA STONE BLACK  
RETTIFICATO 60x90  
Cod. **83** □



**406074**  
LAVA STONE BLACK  
RETTIFICATO 40x60  
Cod. **70** □



**404024**  
LAVA STONE BLACK  
RETTIFICATO 40x40  
Cod. **71** □



**130098**  
LAVA STONE BLACK  
RETTIFICATO 20x20  
Cod. **96** □



**753024**  
LAVA STONE BLACK  
RETTIFICATO 7,5x30  
Cod. **81** □



**606314**  
LAVA STONE BLACK  
RETTIFICATO 60x60  
Cod. **79** □



**490900**  
LAVA STONE BLACK  
RETTIFICATO 30x60  
Cod. **76** □



**204019**  
LAVA STONE BLACK  
RETTIFICATO 20x40  
Cod. **78** □

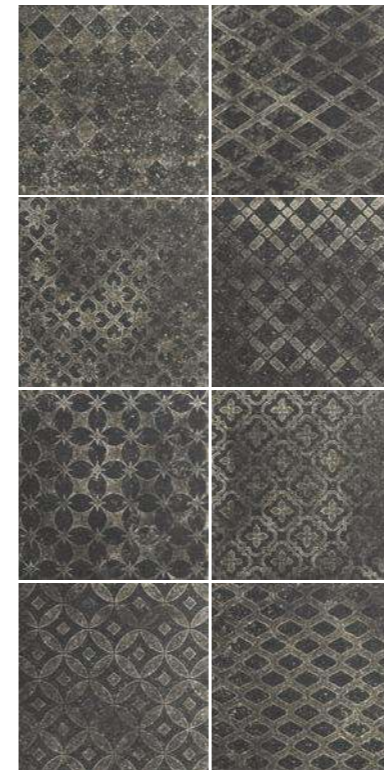

**130094**  
LAVA STONE BLACK  
DECORATO RETTIFICATO 20x20  
Cod. **104** □



**041620**  
LAVA STONE BLACK  
MOSAICO 5x5 SU RETE 30x30  
Cod. **27** ○



**041624**  
LAVA STONE BLACK  
MOSAICO ESAGONO SU RETE 34,7x30  
Cod. **43** ○

IMBALLI • PACKAGES • EMBALLAGES • FORMATE

	SCATOLA • BOX • BOITE • KARTON			PALLET • PALLETS • PALETTS • PALETTE		
	pz	mq	kg	box	mq	kg
<b>90x90</b>	2	1,62	31,90	20	32,40	638,00
<b>60x90</b>	2	1,08	21,70	48	51,84	1.042,00
<b>60x60</b>	3	1,08	20,60	40	43,20	824,00
<b>30x60</b>	6	1,08	20,00	40	43,20	800,00
<b>40x60</b>	4	0,96	19,20	48	46,08	921,00
<b>40x40</b>	6	0,96	19,20	60	57,60	1.152,00
<b>20x40</b>	8	0,64	13,70	72	46,08	986,00
<b>20x20</b>	16	0,64	13,70	72	46,08	986,00
<b>7,5x30</b>	32	0,72	15,00	68	48,96	1.020,00



**909078**  
LAVA STONE TAUPE  
RETTIFICATO 90x90  
Cod. **97** □



**609036**  
LAVA STONE TAUPE  
RETTIFICATO 60x90  
Cod. **83** □



**406075**  
LAVA STONE TAUPE  
RETTIFICATO 40x60  
Cod. **70** □



**404025**  
LAVA STONE TAUPE  
RETTIFICATO 40x40  
Cod. **71** □



**130099**  
LAVA STONE TAUPE  
RETTIFICATO 20x20  
Cod. **96** □



**753025**  
LAVA STONE TAUPE  
RETTIFICATO 7,5x30  
Cod. **81** □



**606315**  
LAVA STONE TAUPE  
RETTIFICATO 60x60  
Cod. **79** □



**490901**  
LAVA STONE TAUPE  
RETTIFICATO 30x60  
Cod. **76** □



**204020**  
LAVA STONE TAUPE  
RETTIFICATO 20x40  
Cod. **78** □



**130095**  
LAVA STONE TAUPE  
DECORATO RETTIFICATO 20x20  
Cod. **104** □



**041621**  
LAVA STONE TAUPE  
MOSAICO 5x5 SU RETE 30x30  
Cod. **27** ○

6  
9,12 kg

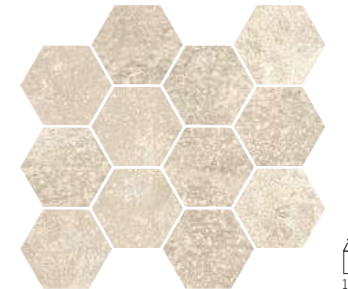

**041625**  
LAVA STONE TAUPE  
MOSAICO ESAGONO SU RETE 34,7x30  
Cod. **43** ○

6  
12,20 kg

IMBALLI • PACKAGES • EMBALLAGES • FORMATE

	SCATOLA • BOX • BOITE • KARTON			PALLET • PALLETS • PALETTS • PALETTE		
	pz	m <sup>q</sup>	kg	box	m <sup>q</sup>	kg
<b>90x90</b>	2	1,62	31,90	20	32,40	638,00
<b>60x90</b>	2	1,08	21,70	48	51,84	1.042,00
<b>60x60</b>	3	1,08	20,60	40	43,20	824,00
<b>30x60</b>	6	1,08	20,00	40	43,20	800,00
<b>40x60</b>	4	0,96	19,20	48	46,08	921,00
<b>40x40</b>	6	0,96	19,20	60	57,60	1.152,00
<b>20x40</b>	8	0,64	13,70	72	46,08	986,00
<b>20x20</b>	16	0,64	13,70	72	46,08	986,00
<b>7,5x30</b>	32	0,72	15,00	68	48,96	1.020,00



Suggerimenti di posa • Laying proposals • Solutions de pose • Verlegevorschläge

## COMPO 1 MIX BOX

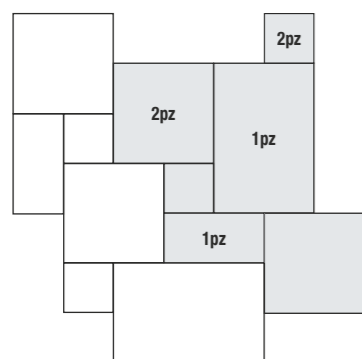

**406068**  
LAVA STONE SHADOW RETTIFICATO  
MIX BOX 40x60 - 40x40 - 20x40 - 20x20  
Cod. **120** □

**406069**  
LAVA STONE IVORY RETTIFICATO  
MIX BOX 40x60 - 40x40 - 20x40 - 20x20  
Cod. **120** □

**406070**  
LAVA STONE BLACK RETTIFICATO  
MIX BOX 40x60 - 40x40 - 20x40 - 20x20  
Cod. **120** □

**406071**  
LAVA STONE TAUPE RETTIFICATO  
MIX BOX 40x60 - 40x40 - 20x40 - 20x20  
Cod. **120** □

**609042**  
LAVA STONE SHADOW RETTIFICATO **R11**  
MIX BOX 40x60 - 40x40 - 20x40 - 20x20  
Cod. **79** □

**609043**  
LAVA STONE IVORY RETTIFICATO **R11**  
MIX BOX 40x60 - 40x40 - 20x40 - 20x20  
Cod. **79** □

**609044**  
LAVA STONE BLACK RETTIFICATO **R11**  
MIX BOX 40x60 - 40x40 - 20x40 - 20x20  
Cod. **79** □

**609045**  
LAVA STONE TAUPE RETTIFICATO **R11**  
MIX BOX 40x60 - 40x40 - 20x40 - 20x20  
Cod. **79** □

### IMBALLI • PACKAGES • EMBALLAGES • FORMATE

	SCATOLA • BOX • BOITE • KARTON			PALLET • PALLETS • PALETTS • PALETTE		
	pz	mq	kg	box	mq	kg
<b>MIX BOX</b>	6	0,72	15,30	40	28,80	613,00

## COMPO 1

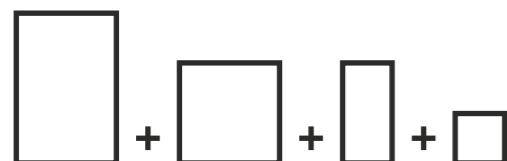

**406076**  
LAVA STONE SHADOW RETTIFICATO  
COMPO 40x60 - 40x40 - 20x40 - 20x20  
Cod. **117** □

**406077**  
LAVA STONE IVORY RETTIFICATO  
COMPO 40x60 - 40x40 - 20x40 - 20x20  
Cod. **117** □

40 x 60 .....33,46 %    20 x 40 .....11,06 %  
40 x 40 .....44,47 %    20 x 20 .....11,01 %

**406078**  
LAVA STONE BLACK RETTIFICATO  
COMPO 40x60 - 40x40 - 20x40 - 20x20  
Cod. **117** □

**406079**  
LAVA STONE TAUPE RETTIFICATO  
COMPO 40x60 - 40x40 - 20x40 - 20x20  
Cod. **117** □

## COMPO 2

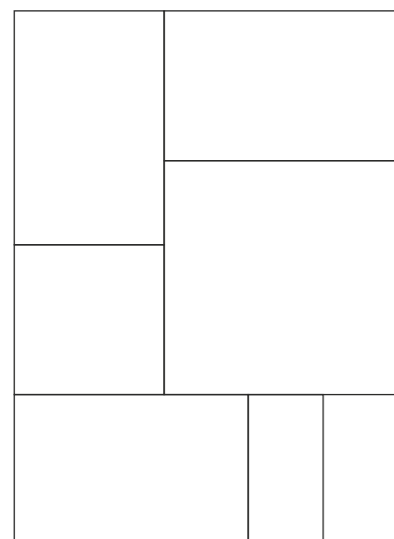

**406080**  
LAVA STONE SHADOW  
COMPO 2 90x90 - 60x90 - 60x60 - 30x60  
Cod. **87** □

**406081**  
LAVA STONE IVORY  
COMPO 2 90x90 - 60x90 - 60x60 - 30x60  
Cod. **87** □

90 x 90 .....27,27 %    60 x 60 .....12,12 %  
60 x 90 .....54,55 %    30 x 60 .....6,06 %

**406082**  
LAVA STONE BLACK  
COMPO 2 90x90 - 60x90 - 60x60 - 30x60  
Cod. **87** □

**406083**  
LAVA STONE TAUPE  
COMPO 2 90x90 - 60x90 - 60x60 - 30x60  
Cod. **87** □

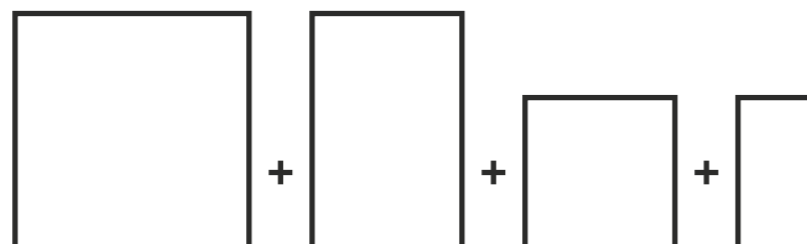

Pezzi speciali • Special trims • Pièces spéciales • Formstücke

## Battiscopa



10,90 kg

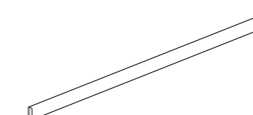

**290926**  
LAVA STONE SHADOW RETTIFICATO  
BATTISCOPA 5x60  
Cod. **121** △

**290927**  
LAVA STONE IVORY RETTIFICATO  
BATTISCOPA 5x60  
Cod. **121** △

**290928**  
LAVA STONE BLACK RETTIFICATO  
BATTISCOPA 5x60  
Cod. **121** △

**290929**  
LAVA STONE TAUPE RETTIFICATO  
BATTISCOPA 5x60  
Cod. **121** △





CARATTERISTICHE DI QUALITÀ Quality characteristics Caractéristiques de qualité Qualitätseigenschaften	NORMA Norm Norme Norme	REQUISITO NORMA Required standards Valeur prescrite selon la norme Normvorgabe	RISULTATO Result Résultat Ergebniss
Assorbimento d'acqua Water absorption of the body Absorption d'eau de support Wasseraufnahme des Scherbens	ISO 10545-3	≤ 0,5	Conforme Conformity Conforme Gemäss
Resistenza a flessione Breaking strenght Résistance à la flexion Biegefestigkeit	ISO 10545-4	≥ 35 N/mm²	Conforme Conformity Conforme Gemäss
Resistenza all'abrasione Abrasion resistance Resistance a l'abrasion Abriebbeständigkeit	EN ISO 10545-7	IVORY - TAUPE - SHADOW	PEI V
		BLACK	PEI IV
Resistenza al gelo Frost resistance Résistance au gel Frostbeständigkeit	ISO 10545-12	Nessun campione deve presentare rotture o alterazioni apprezzabili alla superficie No samples must show ruptures or noticeable surface alteration Aucuns enchantions doit présenter ruptures ou altérations appréciables de la surface Keines der Muster sollte Risse oder sichtbare Fehler der Oberfläche zeigen	Conforme Conformity Conforme Gemäss
Resistenza all'attacco chimico Chemical resistance Résistance à l'attaque chimique Beständigkeit gegen chemikalien	ISO 10545-13		GA GLA
Resistenza agli sbalzi termici Thermal shock resistance Resistance aux ecarts de température Temperaturwechselbeständigkeit	ISO 10545-5		Conforme Conformity Conforme Gemäss
Resistenza scivolosità Sliding resistance Resistance au glissement Rutschfestigkeit	DIN 51130 R	LAVA STONE	R10
		LAVA STONE R11	R11
Resistenza scivolosità Sliding resistance Resistance au glissement Rutschfestigkeit	DIN 51097 (A+B+C)	LAVA STONE	A+B
		LAVA STONE R11	A+B+C
Coefficiente d'attrito dinamico Wet dynamic coefficient of friction Coefficient de friction dynamique Reibungskoeffizient Schlupfrigkeit (in Bewegung)	Bot 3000 E	DCOF ≥ 0,42	> 0,42
Significativa variazione Significant variation Variation important Bedeutsam Abweichung			V3

V1  
Aspetto uniforme  
Uniform appearance  
Aspect uniforme  
Einheitliches Aussehen

V2  
Lieve variazione  
Slight variation  
Légère variation  
Geringe Abweichung

V3  
Significativa variazione  
Significant variation  
Variation important  
Bedeutsam Abweichung

V4  
Forte stonizzazione  
Substantial variation  
Effet dénuancé très accentué  
Akzentuierte Variation

**PER UNA POSA OTTIMALE DEL PRODOTTO CONSIGLIAMO SEMPRE DI MESCOLORE ALMENO TRE SCATOLE DI MATERIALE.**

For the best product laying results, material from at least three boxes should be mixed.

Pour une pose excellente, nous recommandons toujours de mélanger le contenu d'au moins trois boîtes.

Für eine optimale Verlegung des Erzeugnisses empfehlen wir stets, mindestens drei Packungen Material anzumischen.



Tipologia  
Type  
Typologie  
Typ  
Gres porcellanato smaltato  
Glazed porcelain  
Grès cérame emaille  
Feinsteinzeug glasiert

Formati  
Sizes  
Formats  
Formate  
26,5x180  
30x120  
20x120  
10x60  
10x53,7

Spessore  
Thickness  
Épaisseur  
Stärke  
9 mm  
20 mm

Resistenza scivolosità  
Sliding resistance  
Resistance au glissement  
Rutschfestigkeit  
R10 / A+B  
R11 / A+B+C

Grado di variazione cromatica  
Degree of colour change  
Degré de variation chromatique  
Grad der Farbabweichung  
V2



**201225**  
ST. TROPEZ RETTIFICATO 26,5x180  
Cod. 111 □



**301257**  
ST. TROPEZ RETTIFICATO 30x120  
Cod. 92 □



**201228**  
ST. TROPEZ RETTIFICATO 20x120  
Cod. 92 □

**201231**  
ST. TROPEZ RETTIFICATO R11 20x120  
Cod. 95 □



**106037**  
ST. TROPEZ RETTIFICATO 10x60  
Cod. 83 □



**490734**  
ST. TROPEZ MOSAICO MURETTO  
2x10 SU RETE 20x40  
Cod. 125 ○



9,10 kg



**106030**  
ST. TROPEZ CHEVRON  
RETTIFICATO 10x53,7  
Cod. 112 □



**201226**  
ANTIBES RETTIFICATO 26,5x180  
Cod. 111 □



**301258**  
ANTIBES RETTIFICATO 30x120  
Cod. 92 □



**201229**  
ANTIBES RETTIFICATO 20x120  
Cod. 92 □

**201232**  
ANTIBES RETTIFICATO R11 20x120  
Cod. 95 □



**106038**  
ANTIBES RETTIFICATO 10x60  
Cod. 83 □



**490735**  
ANTIBES MOSAICO MURETTO  
2x10 SU RETE 20x40  
Cod. 125 ○



9,10 kg



**106031**  
ANTIBES CHEVRON  
RETTIFICATO 10x53,7  
Cod. 112 □

**IMBALLI • PACKAGES • EMBALLAGES • FORMATE**

	SCATOLA • BOX • BOITE • KARTON			PALLET • PALLETS • PALETTS • PALETTE		
	pz	m <sup>q</sup>	kg	box	m <sup>q</sup>	kg
<b>26,5x180</b>	3	1,43	32,00	36	51,48	1.152,00
<b>30x120</b>	4	1,44	28,50	24	34,56	684,00
<b>20x120</b>	6	1,44	28,50	24	34,56	684,00
<b>10x60</b>	12	0,72	14,30	60	43,20	858,00
<b>10x53,7</b>	12	0,65	12,90	60	39,00	774,00

**IMBALLI • PACKAGES • EMBALLAGES • FORMATE**

	SCATOLA • BOX • BOITE • KARTON			PALLET • PALLETS • PALETTS • PALETTE		
	pz	m <sup>q</sup>	kg	box	m <sup>q</sup>	kg
<b>26,5x180</b>	3	1,43	32,00	36	51,48	1.152,00
<b>30x120</b>	4	1,44	28,50	24	34,56	684,00
<b>20x120</b>	6	1,44	28,50	24	34,56	684,00
<b>10x60</b>	12	0,72	14,30	60	43,20	858,00
<b>10x53,7</b>	12	0,65	12,90	60	39,00	774,00



**201224**  
BIARRITZ RETTIFICATO 26,5x180  
Cod. 111 □



**301256**  
BIARRITZ RETTIFICATO 30x120  
Cod. 92 □



**201227**  
BIARRITZ RETTIFICATO 20x120  
Cod. 92 □

**201230**  
BIARRITZ RETTIFICATO R11 20x120  
Cod. 95 □



**106036**  
BIARRITZ RETTIFICATO 10x60  
Cod. 83 □



**490733**  
BIARRITZ MOSAICO MURETTO  
2x10 SU RETE 20x40  
Cod. 125 ○



9,10 kg



**106029**  
BIARRITZ CHEVRON  
RETTIFICATO 10x53,7  
Cod. 112 □



**301260**  
ST. TROPEZ 2CM RETTIFICATO 30x120  
Cod. 139 □



**301261**  
ANTIBES 2CM RETTIFICATO 30x120  
Cod. 139 □



**301259**  
BIARRITZ 2CM RETTIFICATO 30x120  
Cod. 139 □

IMBALLI • PACKAGES • EMBALLAGES • FORMATE

	SCATOLA • BOX • BOITE • KARTON			PALLET • PALLETS • PALETTS • PALETTE		
	pz	mq	kg	box	mq	kg
26,5x180	3	1,43	32,00	36	51,48	1.152,00
30x120	4	1,44	28,50	24	34,56	684,00
20x120	6	1,44	28,50	24	34,56	684,00
10x60	12	0,72	14,30	60	43,20	858,00
10x53,7	12	0,65	12,90	60	39,00	774,00

IMBALLI • PACKAGES • EMBALLAGES • FORMATE

	SCATOLA • BOX • BOITE • KARTON			PALLET • PALLETS • PALETTS • PALETTE		
	pz	mq	kg	box	mq	kg
30x120 (20mm)	2	0,72	29,80	30	21,60	895,00

Pezzi speciali • Special trims • Pièces spéciales • Formstücke

## Battiscopa



11,40 kg

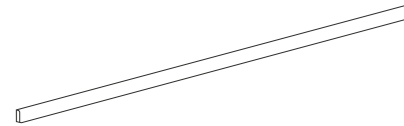

**290789**  
ST. TROPEZ BATTISCOPA RETTIFICATO  
5x120  
Cod. **33** △

**290790**  
ANTIBES BATTISCOPA RETTIFICATO  
5x120  
Cod. **33** △

**290788**  
BIARRITZ BATTISCOPA RETTIFICATO  
5x120  
Cod. **33** △

## Gradino



14,40 kg

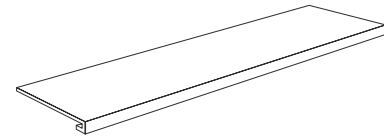

**490737**  
ST. TROPEZ GRADINO  
RETTIFICATO 30x120  
Cod. **114** ○

**490738**  
ANTIBES GRADINO  
RETTIFICATO 30x120  
Cod. **114** ○

**490736**  
BIARRITZ GRADINO  
RETTIFICATO 30x120  
Cod. **114** ○

## Angolare



16,00 kg

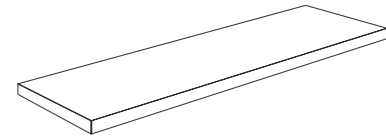

**490740**  
ST. TROPEZ ANGOLARE  
RETTIFICATO 30x120  
Cod. **110** ○

**490741**  
ANTIBES ANGOLARE  
RETTIFICATO 30x120  
Cod. **110** ○

**490739**  
BIARRITZ ANGOLARE  
RETTIFICATO 30x120  
Cod. **110** ○

CARATTERISTICHE DI QUALITÀ Quality characteristics Caractéristiques de qualité Qualitätseigenschaften	NORMA Norm Norme Norme	REQUISITO NORMA Required standards Valeur prescrite selon la norme Normvorgabe	RISULTATO Result Résultat Ergebniss
Assorbimento d'acqua Water absorption of the body Absorption d'eau de support Wasseraufnahme des Scherbens	ISO 10545-3	≤ 0,5	Conforme Conformity Conforme Gemäss
Resistenza a flessione Breaking strenght Résistance à la flexion Biegefestigkeit	ISO 10545-4	≥ 35 N/mm <sup>2</sup>	Conforme Conformity Conforme Gemäss
Resistenza all'abrasione Abrasion resistance Resistance a l'abrasion Abriebbeständigkeit	EN ISO 10545-7		PEI IV
Resistenza al gelo Frost resistance Résistance au gel Frostbeständigkeit	ISO 10545-12	Nessun campione deve presentare rotture o alterazioni apprezzabili alla superficie No samples must show ruptures or noticeable surface alteration Aucuns enchantions doit présenter ruptures ou altérations appréciables de la surface Keines der Muster sollte Risse oder sichtbare Fehler der Oberfläche zeigen	Conforme Conformity Conforme Gemäss
Resistenza all'attacco chimico Chemical resistance Résistance à l'attaque chimique Beständigkeit gegen chemikalien	ISO 10545-13	Nessun campione deve presentare alterazioni visibili all'attacco chimico No samples must show visible signs of chemical attack Aucuns enchantions doit présenter des altérations visibles à l'attaque chimique Keines der Muster sollte sehenswerte Aenderungen nach Behandlung mit Chemikalien zeigen	Conforme Conformity Conforme Gemäss
Resistenza agli sbalzi termici Thermal shock resistance Resistance aux ecart de température Temperaturwechselbeständigkeit	ISO 10545-5		Conforme Conformity Conforme Gemäss
Resistenza scivolosità Sliding resistance Resistance au glissement Rutschfestigkeit	DIN 51130 R	Versione 9 mm 30x120cm 20mm   20x120cm 9 mm R11	R10 R11
Resistenza scivolosità Sliding resistance Resistance au glissement Rutschfestigkeit	DIN 51097 (A+B+C)	Versione 9 mm 30x120cm 20mm   20x120cm 9 mm R11	A+B A+B+C
Coefficiente d'attrito dinamico Wet dynamic coefficient of friction Coefficient de friction dynamique Reibungskoeffizient Schlipfrigkeit (in Bewegung)	Bot 3000 E	DCOF ≥ 0,42	> 0,42
Lieve variazione Slight variation Légère variation Geringe Abweichung			V2

**V1**  
Aspetto uniforme  
Uniform appearance  
Aspect uniforme  
Einheitliches Aussehen

**V2**  
Lieve variazione  
Slight variation  
Légère variation  
Geringe Abweichung

**V3**  
Significativa variazione  
Significant variation  
Variation important  
Bedeutsam Abweichung

**V4**  
Forte stonalizzazione  
Substantial variation  
Effet dénuancé très accentué  
Akzentuierte Variation



Tipologia  
Type  
Typologie  
Typ  
Gres porcellanato smaltato  
Glazed porcelain  
Grès cérame émaille  
Feinsteinzeug glasiert

Formati  
Sizes  
Formats  
Formate  
60x120  
60x60  
30x60  
30x30  
10x30

Spessore  
Thickness  
Épaisseur  
Stärke  
9 mm

Resistenza scivolosità  
Sliding resistance  
Resistance au glissement  
Rutschfestigkeit  
R9

Grado di variazione cromatica  
Degree of colour change  
Degré de variation chromatique  
Grad der Farbabweichung  
V3



**601264**  
LUXURY GREY NATURALE  
RETTIFICATO 60x120  
Cod. **94** □

**601265**  
LUXURY GREY LAPPATO  
RETTIFICATO 60x120  
Cod. **103** □

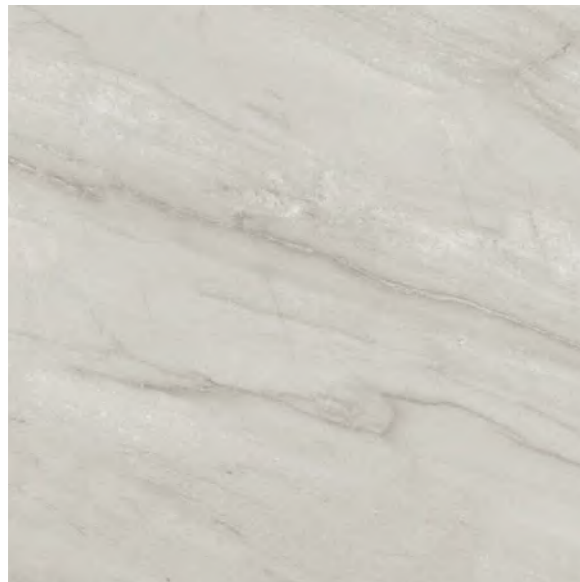

**606201**  
LUXURY GREY NATURALE  
RETTIFICATO 60x60  
Cod. **79** □

**606203**  
LUXURY GREY LAPPATO  
RETTIFICATO 60x60  
Cod. **93** □

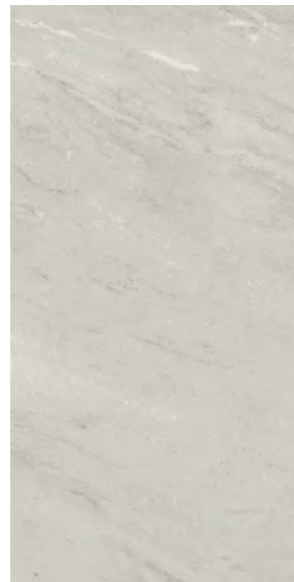

**490559**  
LUXURY GREY NATURALE  
RETTIFICATO 30x60  
Cod. **76** □

**490561**  
LUXURY GREY LAPPATO  
RETTIFICATO 30x60  
Cod. **85** □

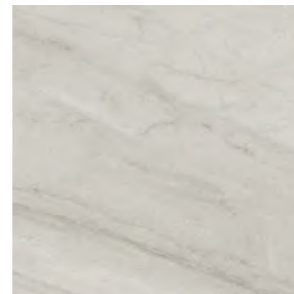

**040918**  
LUXURY GREY NATURALE RETTIFICATO 30x30  
Cod. **78** □

**040922**  
LUXURY GREY LAPPATO RETTIFICATO 30x30  
Cod. **90** □

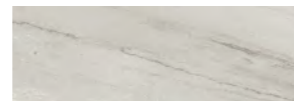

**103102**  
LUXURY GREY NATURALE  
RETTIFICATO 10x30  
Cod. **77** □

**103105**  
LUXURY GREY LAPPATO  
RETTIFICATO 10x30  
Cod. **93** □

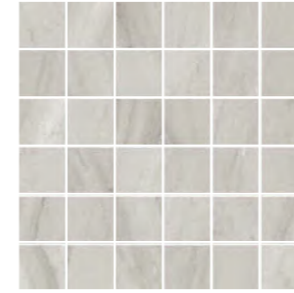

**041119**  
LUXURY GREY NATURALE  
MOSAICO 5x5 SU RETE 30x30  
Cod. **24** ○

**041130**  
LUXURY GREY LAPPATO  
MOSAICO 5x5 SU RETE 30x30  
Cod. **31** ○

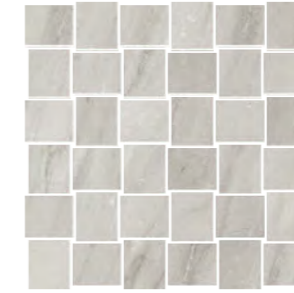

**041122**  
LUXURY GREY NATURALE MOSAICO  
INTARSIO SU RETE 30x30  
Cod. **31** ○

**041133**  
LUXURY GREY LAPPATO  
MOSAICO INTARSIO SU RETE 30x30  
Cod. **35** ○



**041124**  
LUXURY GREY NATURALE  
MOSAICO HB SU RETE 28x32  
Cod. **45** ○

**041132**  
LUXURY GREY LAPPATO  
MOSAICO HB SU RETE 28x32  
Cod. **48** ○

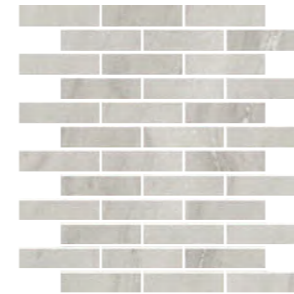

**041120**  
LUXURY GREY NATURALE  
MOSAICO MURETTO 2,4x10 SU RETE 30x30  
Cod. **46** ○

**041131**  
LUXURY GREY LAPPATO  
MOSAICO MURETTO 2,4x10 SU RETE 30x30  
Cod. **58** ○



**041121**  
LUXURY GREY NATURALE  
MOSAICO ESAGONO SU RETE 27x28  
Cod. **136** ○

**041129**  
LUXURY GREY LAPPATO  
MOSAICO ESAGONO SU RETE 27x28  
Cod. **49** ○



**041171**  
LUXURY GREY NATURALE  
MOSAICO ARABESQUE SU RETE 30x30  
Cod. **57** ○

**041172**  
LUXURY GREY LAPPATO  
MOSAICO ARABESQUE SU RETE 30x30  
Cod. **72** ○



IMBALLI • PACKAGES • EMBALLAGES • FORMATE

	SCATOLA • BOX • BOITE • KARTON			PALLET • PALLETS • PALETTS • PALETTE		
	pz	mq	kg	box	mq	kg
<b>60x120</b>	2	1,44	30,20	30	43,20	906,00
<b>60x60</b>	3	1,08	22,60	40	43,20	904,00
<b>30x60</b>	6	1,08	22,60	40	43,20	904,00
<b>30x30</b>	11	0,99	21,20	46	45,54	975,00
<b>10x30</b>	20	0,60	12,90	60	36,00	774,00



**380266**  
LUXURY GREY NATURALE  
LONDON 5x30  
Cod. **33** ○



**380267**  
LUXURY GREY LUCIDO  
LONDON 5x30  
Cod. **33** ○





## luxury grey RETT. LAPPATO

La finitura lappata è consigliata per uso rivestimento o per pavimenti da bagno in ambito residenziale. Nello specifico il tipo di pavimentazione deve essere non soggetta ad eccessive sollecitazioni e mai a diretto contatto con aree esterne. Come si verifica comunemente nelle pietre naturali l'eventuale presenza di puntini sulla superficie o di qualche disuniformità della lucentezza sono da considerare caratteristiche del prodotto derivanti dalla lavorazione a cui viene sottoposto.

The polished finish is recommended for wall coverings or for the floors of residential bathrooms. Specifically, floor coverings in this material must not be subjected to excessively heavy traffic and must never be in direct contact with outdoor areas. As is often the case with natural stones, any spots on the surface or any unevenness in shine are typical characteristics of the product, deriving from the process used.

La finition polie est recommandée pour le revêtement sol et mur des salles de bains résidentielles. Notamment, ce type de carreau au sol ne doit pas être exposé à des contraintes excessives, et il ne doit jamais être en contact direct avec des zones extérieures. Comme cela est souvent le cas pour les pierres naturelles, les micro trous éventuellement présents à la surface du produit ou l'hétérogénéité de son éclat forment des caractéristiques propres au façonnage.

Die polierte Oberfläche wird für Wandverkleidungen und Bodenbeläge in Privatbädern empfohlen. Der Bodenbelag darf keinen starken Beanspruchungen ausgesetzt sein und keinen direkten Kontakt zu Außenbereichen haben. Wie bei Natursteinen üblich, kann die Oberfläche Körnungen oder einen unregelmäßigen Glanz aufweisen. Diese Merkmale sind typische, beabsichtigte Produkteigenschaften, die durch das Bearbeitungsverfahren hervorgerufen werden.

Pezzi speciali • Special trims • Pièces spéciales • Formstücke

Battiscopa	44 22,40 kg	18 17,10 kg	
	<b>290709</b> LUXURY GREY NATURALE BATTISCOPA 7x30 Cod. <b>116</b> △		<b>290739</b> LUXURY GREY NATURALE BATTISCOPA 7x60 Cod. <b>121</b> △
	<b>290710</b> LUXURY GREY LAPPATO BATTISCOPA 7x30 Cod. <b>22</b> △		<b>290740</b> LUXURY GREY LAPPATO BATTISCOPA 7x60 Cod. <b>26</b> △

CARATTERISTICHE DI QUALITÀ Quality characteristics Caractéristiques de qualité Qualitätseigenschaften	NORMA Norm Norme	REQUISITO NORMA Required standards Valeur prescrite selon la norme Normvorgabe	RISULTATO Result Résultat Ergebniss
Assorbimento d'acqua Water absorption of the body Absorption d'eau de support Wasseraufnahme des Scherbens	ISO 10545-3	≤ 0,5	Conforme Conformity Conforme Gemäss
Resistenza a flessione Breaking strenght Résistance à la flexion Biegefestigkeit	ISO 10545-4	≥ 35 N/mm <sup>2</sup>	Conforme Conformity Conforme Gemäss
Resistenza all'abrasione Abrasion resistance Résistance à l'abrasion Abriebbeständigkeit	ISO 10545-7	Luxury Grey Rettificato  Luxury Grey Lappato	PEI IV
Resistenza al gelo Frost resistance Résistance au gel Frostbeständigkeit	ISO 10545-12	Nessun campione deve presentare rotture o alterazioni apprezzabili alla superficie No samples must show ruptures or noticeable surface alteration Aucuns enchantions doit présenter ruptures ou altérations appréciables de la surface Keines der Muster sollte Risse oder sichtbare Fehler der Oberfläche zeigen	Conforme Conformity Conforme Gemäss
Resistenza all'attacco chimico Chemical resistance Résistance à l'attaque chimique Beständigkeit gegen chemikalien	ISO 10545-13	Luxury Grey Rettificato  Luxury Grey Lappato	GA GLA  GA GLB
Resistenza agli sbalzi termici Thermal shock resistance Résistance aux écarts de température Temperaturwechselbeständigkeit	ISO 10545-5		Conforme Conformity Conforme Gemäss
Resistenza scivolosità Sliding resistance Résistance au glissement Rutschfestigkeit	DIN 51130 R	Luxury Grey Rettificato  Luxury Grey Lappato	R9
Significativa variazione Significant variation Variation important Bedeutsam Abweichung			V3

V1	Aspetto uniforme Uniform appearance Aspect uniforme Einheitliches Aussehen	V2	Lieve variazione Slight variation Légère variation Geringe Abweichung	V3	Significativa variazione Significant variation Variation important Bedeutsam Abweichung	V4	Forte stonalizzazione Substantial variation Effet dénuancé très accentué Akzentuierte Variation
----	---	----	--	----	--	----	--

**PER UNA POSA OTTIMALE DEL PRODOTTO CONSIGLIAMO SEMPRE DI MESCOLARE ALMENO TRE SCATOLE DI MATERIALE.**  
For the best product laying results, material from at least three boxes should be mixed.  
Pour une pose excellente, nous recommandons toujours de mélanger le contenu d'au moins trois boîtes.  
Für eine optimale Verlegung des Erzeugnisses empfehlen wir stets, mindestens drei Packungen Material anzumischen.



Tipologia  
Type  
Typologie  
Typ  
Gres porcellanato smaltato  
Glazed porcelain  
Grès cérame emaille  
Feinsteinzeug glasiert

Formati  
Sizes  
Formats  
Formate  
60x120  
60x60  
30x60  
10x30

Spessore  
Thickness  
Épaisseur  
Stärke  
9 mm

Resistenza scivolosità  
Sliding resistance  
Resistance au glissement  
Rutschfestigkeit  
R9

Grado di variazione cromatica  
Degree of colour change  
Degré de variation chromatique  
Grad der Farbabweichung  
V3



**601337**  
MACCHIA ANTICA NATURALE  
RETTIFICATO 60x120  
Cod. **94** □

**601338**  
MACCHIA ANTICA LAPPATO  
RETTIFICATO 60x120  
Cod. **103** □



**606296**  
MACCHIA ANTICA NATURALE  
RETTIFICATO 60x60  
Cod. **79** □

**606297**  
MACCHIA ANTICA LAPPATO  
RETTIFICATO 60x60  
Cod. **93** □



**490869**  
MACCHIA ANTICA NATURALE  
RETTIFICATO 30x60  
Cod. **76** □

**490870**  
MACCHIA ANTICA LAPPATO  
RETTIFICATO 30x60  
Cod. **85** □



**103163**  
MACCHIA ANTICA NATURALE  
RETTIFICATO 10x30  
Cod. **77** □

**103164**  
MACCHIA ANTICA LAPPATO  
RETTIFICATO 10x30  
Cod. **93** □



9,30 kg

**041630**  
MACCHIA ANTICA NATURALE  
MOSAICO 5x5 SU RETE 30x30  
Cod. **24** ○

**041626**  
MACCHIA ANTICA LAPPATO  
MOSAICO 5x5 SU RETE 30x30  
Cod. **31** ○



8,90 kg

**041543**  
MACCHIA ANTICA NATURALE  
MOSAICO ESAGONO SU RETE 27x28  
Cod. **136** ○

**041544**  
MACCHIA ANTICA LAPPATO  
MOSAICO ESAGONO SU RETE 27x28  
Cod. **49** ○



10,20 kg

**041511**  
MACCHIA ANTICA NATURALE  
MOSAICO HB SU RETE 28x32  
Cod. **45** ○

**041512**  
MACCHIA ANTICA LAPPATO  
MOSAICO HB SU RETE 28x32  
Cod. **48** ○



6,50 kg

**041575**  
MACCHIA ANTICA NATURALE  
MOSAICO ESAGONO INTARSIO SU RETE 20,7x27  
Cod. **57** ○

**041576**  
MACCHIA ANTICA LAPPATO  
MOSAICO ESAGONO INTARSIO SU RETE 20,7x27  
Cod. **72** ○



8,90 kg

**041559**  
MACCHIA ANTICA NATURALE  
MOSAICO FANCY SU RETE 24x30  
Cod. **51** ○

**041560**  
MACCHIA ANTICA LAPPATO  
MOSAICO FANCY SU RETE 24x30  
Cod. **71** ○

**IMBALLI • PACKAGES • EMBALLAGES • FORMATE**

	SCATOLA • BOX • BOITE • KARTON			PALLET • PALLETS • PALETTS • PALETTE		
	pz	mq	kg	box	mq	kg
<b>60x120</b>	2	1,44	30,20	30	43,20	906,00
<b>60x60</b>	3	1,08	22,60	40	43,20	904,00
<b>30x60</b>	6	1,08	22,60	40	43,20	975,00
<b>10x30</b>	20	0,60	12,90	60	36,00	774,00



## macchia antica RETT. LAPPATO

La finitura lappata è consigliata per uso rivestimento o per pavimenti da bagno in ambito residenziale. Nello specifico il tipo di pavimentazione deve essere non soggetta ad eccessive sollecitazioni e mai a diretto contatto con aree esterne. Come si verifica comunemente nelle pietre naturali l'eventuale presenza di puntini sulla superficie o di qualche disuniformità della lucentezza sono da considerare caratteristiche del prodotto derivanti dalla lavorazione a cui viene sottoposto.

The polished finish is recommended for wall coverings or for the floors of residential bathrooms. Specifically, floor coverings in this material must not be subjected to excessively heavy traffic and must never be in direct contact with outdoor areas. As is often the case with natural stones, any spots on the surface or any unevenness in shine are typical characteristics of the product, deriving from the process used.

La finitura polie est recommandée pour le revêtement sol et mur des salles de bains résidentielles. Notamment, ce type de carreau au sol ne doit pas être exposé à des contraintes excessives, et il ne doit jamais être en contact direct avec des zones extérieures. Comme cela est souvent le cas pour les pierres naturelles, les micro trous éventuellement présents à la surface du produit ou l'hétérogénéité de son éclat forment des caractéristiques propres au façonnage.

Die polierte Oberfläche wird für Wandverkleidungen und Bodenbeläge in Privatbädern empfohlen. Der Bodenbelag darf keinen starken Beanspruchungen ausgesetzt sein und keinen direkten Kontakt zu Außenbereichen haben. Wie bei Natursteinen üblich, kann die Oberfläche Körnungen oder einen unregelmäßigen Glanz aufweisen. Diese Merkmale sind typische, beabsichtigte Produkteigenschaften, die durch das Bearbeitungsverfahren hervorgerufen werden.

Pezzi speciali • Special trims • Pièces spéciales • Formstücke

Battiscopa

44  
22,40 kg

18  
17,10 kg

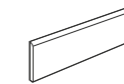

**290880**  
MACCHIA ANTICA NATURALE  
BATTISCOPA 7x30  
Cod. **116** △

**290881**  
MACCHIA ANTICA LAPPATO  
BATTISCOPA 7x30  
Cod. **22** △

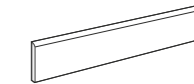

**290896**  
MACCHIA ANTICA NATURALE  
BATTISCOPA 7x60  
Cod. **121** △

**290897**  
MACCHIA ANTICA LAPPATO  
BATTISCOPA 7x60  
Cod. **26** △

CARATTERISTICHE DI QUALITÀ Quality characteristics Caractéristiques de qualité Qualitätseigenschaften	NORMA Norm Norme Norme	REQUISITO NORMA Required standards Valeur prescrite selon la norme Normvorgabe	RISULTATO Result Résultat Ergebniss
Assorbimento d'acqua Water absorption of the body Absorption d'eau de support Wasseraufnahme des Scherbens	ISO 10545-3	≤ 0,5	Conforme Conformity Conforme Gemäss
Resistenza a flessione Breaking strenght Résistance à la flexion Biegefestigkeit	ISO 10545-4	≥ 35 N/mm <sup>2</sup>	Conforme Conformity Conforme Gemäss
Resistenza all'abrasione Abrasion resistance Résistance à l'abrasion Abriebbeständigkeit	ISO 10545-7	MACCHIA ANTICA Rettificato	PEI IV
Resistenza al gelo Frost resistance Résistance au gel Frostbeständigkeit	ISO 10545-12	Nessun campione deve presentare rotture o alterazioni apprezzabili alla superficie No samples must show ruptures or noticeable surface alteration Aucuns enchantions doit présenter ruptures ou altérations appréciables de la surface Keines der Muster sollte Risse oder sichtbare Fehler der Oberfläche zeigen	Conforme Conformity Conforme Gemäss
Resistenza all'attacco chimico Chemical resistance Résistance à l'attaque chimique Beständigkeit gegen chemikalien	ISO 10545-13	MACCHIA ANTICA Naturale MACCHIA ANTICA Lappato	GA GLA GA GLB
Resistenza agli sbalzi termici Thermal shock resistance Résistance aux écarts de température Temperaturwechselbeständigkeit	ISO 10545-5		Conforme Conformity Conforme Gemäss
Resistenza scivolosità Sliding resistance Résistance au glissement Rutschfestigkeit	DIN 51130 R		R9
Significativa variazione Significant variation Variation important Bedeutsam Abweichung		MACCHIA ANTICA Rettificato	V3

Aspetto uniforme  
Uniform appearance  
Aspect uniforme  
Einheitliches Aussehen  
**V1**

Lieve variazione  
Slight variation  
Légère variation  
Geringe Abweichung  
**V2**

Significativa variazione  
Significant variation  
Variation important  
Bedeutsam Abweichung  
**V3**

Forte stonalizzazione  
Substantial variation  
Effet dénuancé très accentué  
Akzentuierte Variation  
**V4**

**PER UNA POSA OTTIMALE DEL PRODOTTO CONSIGLIAMO SEMPRE DI MESCOLARE ALMENO TRE SCATOLE DI MATERIALE.**

For the best product laying results, material from at least three boxes should be mixed.

Pour une pose excellente, nous recommandons toujours de mélanger le contenu d'au moins trois boîtes.

Für eine optimale Verlegung des Erzeugnisses empfehlen wir stets, mindestens drei Packungen Material anzumischen.



Tipologia  
Type  
Typologie  
Typ  
Gres porcellanato smaltato  
Glazed porcelain  
Grès cérame emaille  
Feinsteinzeug glasiert

Formati  
Sizes  
Formats  
Formate  
30x60  
15x60  
30x30  
10x30  
15x15  
7,5x15  
10x10

Spessore  
Thickness  
Épaisseur  
Stärke  
9 mm

Resistenza scivolosità  
Sliding resistance  
Resistance au glissement  
Rutschfestigkeit  
R9

Grado di variazione cromatica  
Degree of colour change  
Degré de variation chromatique  
Grad der Farbabweichung  
V3



**490364**  
MARMOBIANCO NATURALE RETTIFICATO 30x60  
Cod. **76** □

**490365**  
MARMOBIANCO LAPPATO RETTIFICATO 30x60  
Cod. **85** □

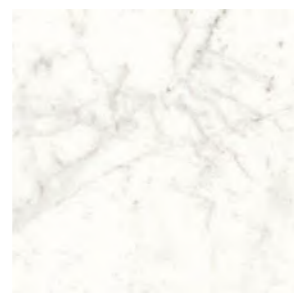

**040832**  
MARMOBIANCO NATURALE RETTIFICATO 30x30  
Cod. **78** □

**040833**  
MARMOBIANCO LAPPATO RETTIFICATO 30x30  
Cod. **90** □



**550098**  
MARMOBIANCO NATURALE RETTIFICATO 15x60  
Cod. **76** □

**550099**  
MARMOBIANCO LAPPATO RETTIFICATO 15x60  
Cod. **85** □



**230234**  
MARMOBIANCO NATURALE RETTIFICATO 15x15  
Cod. **78** □

**230235**  
MARMOBIANCO LAPPATO RETTIFICATO 15x15  
Cod. **90** □



**103048**  
MARMOBIANCO NATURALE RETTIFICATO 10x30  
Cod. **77** □

**103049**  
MARMOBIANCO LAPPATO RETTIFICATO 10x30  
Cod. **93** □



**450360**  
MARMOBIANCO NATURALE SFUSO 10x10  
Cod. **90** □

**450361**  
MARMOBIANCO LAPPATO SFUSO 10x10  
Cod. **106** □



**040834**  
MARMOBIANCO NATURALE SFUSO 7,5x15  
Cod. **95** □

**040835**  
MARMOBIANCO LAPPATO SFUSO 7,5x15  
Cod. **111** □



**040836**  
MARMOBIANCO NATURALE MOSAICO 5x5 SU RETE 30x30  
Cod. **24** ○

**040837**  
MARMOBIANCO LAPPATO MOSAICO 5x5 SU RETE 30x30  
Cod. **31** ○



**040840**  
MARMOBIANCO NATURALE MOSAICO BASKETWAVE SU RETE 30x30  
Cod. **47** ○

**040841**  
MARMOBIANCO LAPPATO MOSAICO BASKETWAVE SU RETE 30x30  
Cod. **60** ○



**040838**  
MARMOBIANCO NATURALE MOSAICO MOSAICO MURETTO 2,4x10 SU RETE 30x30  
Cod. **46** ○

**040839**  
MARMOBIANCO LAPPATO MOSAICO MOSAICO MURETTO 2,4x10 SU RETE 30x30  
Cod. **58** ○



**040883**  
MARMOBIANCO NATURALE MOSAICO MOSAICO ESAGONO SU RETE 27x28  
Cod. **136** ○

**040884**  
MARMOBIANCO LAPPATO MOSAICO MOSAICO ESAGONO SU RETE 27x28  
Cod. **49** ○



**380172**  
MARMOBIANCO NATURALE NATURALE LONDON 5x30  
Cod. **33** ○

**380173**  
MARMOBIANCO LUCIDO LONDON 5x30  
Cod. **33** ○



**380171**  
MARMOBIANCO NATURALE BORDURA MURETTO RETTIFICATO 7x30 SU RETE  
Cod. **28** ○

**380174**  
MARMOBIANCO LAPPATO BORDURA MURETTO 7x30 SU RETE  
Cod. **28** ○



**380170**  
MARMOBIANCO NATURALE BORDURA HYDRO 7x30 SU RETE  
Cod. **123** ○

**380175**  
MARMOBIANCO LAPPATO BORDURA HYDRO 7x30 SU RETE  
Cod. **123** ○

IMBALLI • PACKAGES • EMBALLAGES • FORMATE

	SCATOLA • BOX • BOITE • KARTON			PALLET • PALLETS • PALETTS • PALETTE		
	pz	mq	kg	box	mq	kg
<b>30x60</b>	6	1,08	22,60	40	43,20	904,00
<b>15x60</b>	10	0,90	21,30	48	42,20	1.022,00
<b>30x30</b>	11	0,99	21,90	46	45,54	1.007,00
<b>10x30</b>	20	0,60	12,90	60	36,00	774,00
<b>15x15</b>	46	1,035	22,00	33	34,15	726,00
<b>10x10</b>	50	0,50	12,10	36	18,00	432,00
<b>7,5x15</b>	50	0,56	12,70	76	42,56	965,00



## marmobianco RETT. LAPPATO

La finitura lappata è consigliata per uso rivestimento o per pavimenti da bagno in ambito residenziale. Nello specifico il tipo di pavimentazione deve essere non soggetta ad eccessive sollecitazioni e mai a diretto contatto con aree esterne. Come si verifica comunemente nelle pietre naturali l'eventuale presenza di puntini sulla superficie o di qualche disuniformità della lucentezza sono da considerare caratteristiche del prodotto derivanti dalla lavorazione a cui viene sottoposto.

The polished finish is recommended for wall coverings or for the floors of residential bathrooms. Specifically, floor coverings in this material must not be subjected to excessively heavy traffic and must never be in direct contact with outdoor areas. As is often the case with natural stones, any spots on the surface or any unevenness in shine are typical characteristics of the product, deriving from the process used.

La finitura polie est recommandée pour le revêtement sol et mur des salles de bains résidentielles. Notamment, ce type de carreau au sol ne doit pas être exposé à des contraintes excessives, et il ne doit jamais être en contact direct avec des zones extérieures. Comme cela est souvent le cas pour les pierres naturelles, les micro trous éventuellement présents à la surface du produit ou l'hétérogénéité de son éclat forment des caractéristiques propres au façonnage.

Die polierte Oberfläche wird für Wandverkleidungen und Bodenbeläge in Privatbädern empfohlen. Der Bodenbelag darf keinen starken Beanspruchungen ausgesetzt sein und keinen direkten Kontakt zu Außenbereichen haben. Wie bei Natursteinen üblich, kann die Oberfläche Körnungen oder einen unregelmäßigen Glanz aufweisen. Diese Merkmale sind typische, beabsichtigte Produkteigenschaften, die durch das Bearbeitungsverfahren hervorgerufen werden.

Pezzi speciali • Special trims • Pièces spéciales • Formstücke

Battiscopa  22,40 kg

 17,10 kg

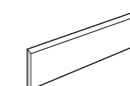





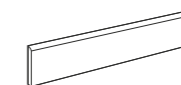







**290557**  
MARMOBIANCO NATURALE  
BATTISCOPA 7x30  
Cod. **116** △

**290558**  
MARMOBIANCO LAPPATO  
BATTISCOPA 7x30  
Cod. **22** △



**290582**  
MARMOBIANCO NATURALE  
BATTISCOPA 7x60  
Cod. **121** △

**290583**  
MARMOBIANCO LAPPATO  
BATTISCOPA 7x60  
Cod. **26** △

CARATTERISTICHE DI QUALITÀ Quality characteristics Caractéristiques de qualité Qualitätseigenschaften	NORMA Norm Norme Norme	REQUISITO NORMA Required standards Valeur prescrite selon la norme Normvorgabe	RISULTATO Result Résultat Ergebniss
 Assorbimento d'acqua Water absorption of the body Absorption d'eau de support Wasseraufnahme des Scherbens	ISO 10545-3	≤ 0,5	Conforme Conformity Conforme Gemäss
 Resistenza a flessione Breaking strenght Résistance à la flexion Biegefestigkeit	ISO 10545-4	≥ 35 N/mm <sup>2</sup>	Conforme Conformity Conforme Gemäss
 Resistenza all'abrasione Abrasion resistance Résistance à l'abrasion Abriebbeständigkeit	ISO 10545-7	Marmobianco Rettificato Marmobianco Lappato	PEI IV
 Resistenza al gelo Frost resistance Résistance au gel Frostbeständigkeit	ISO 10545-12	Nessun campione deve presentare rotture o alterazioni apprezzabili alla superficie No samples must show ruptures or noticeable surface alteration Aucuns enchantions doit présenter ruptures ou altérations appréciables de la surface Keines der Muster sollte Risse oder sichtbare Fehler der Oberfläche zeigen	Conforme Conformity Conforme Gemäss
 Resistenza all'attacco chimico Chemical resistance Résistance à l'attaque chimique Beständigkeit gegen chemikalien	ISO 10545-13	Marmobianco Rettificato Marmobianco Lappato	GA GLA GA GLB
 Resistenza agli sbalzi termici Thermal shock resistance Résistance aux écarts de température Temperaturwechselbeständigkeit	ISO 10545-5		Conforme Conformity Conforme Gemäss
 Resistenza scivolosità Sliding resistance Résistance au glissement Rutschfestigkeit	DIN 51130 R	Marmobianco Rettificato Marmobianco Lappato	R9
 Significativa variazione Significant variation Variation important Bedeutsam Abweichung			V3
 Aspetto uniforme Uniform appearance Aspect uniforme Einheitliches Aussehen	V1		
 Lieve variazione Slight variation Légère variation Geringe Abweichung	V2		
 Significativa variazione Significant variation Variation important Bedeutsam Abweichung	V3		
 Forte stonizzazione Substantial variation Effet dénuancé très accentué Akzentuierte Variation	V4		

**PER UNA POSA OTTIMALE DEL PRODOTTO CONSIGLIAMO SEMPRE DI MESCOLARE ALMENO TRE SCATOLE DI MATERIALE.**

For the best product laying results, material from at least three boxes should be mixed.

Pour une pose excellente, nous recommandons toujours de mélanger le contenu d'au moins trois boîtes.

Für eine optimale Verlegung des Erzeugnisses empfehlen wir stets, mindestens drei Packungen Material anzumischen.



Tipologia  
Type  
Typologie  
Typ  
Gres porcellanato tutta massa  
Through-body porcelain  
Grès cérame dans la masse  
Vollmassiges Feinsteinzeug

Formati  
Sizes  
Formats  
Formate  
60x120  
60x60  
30x60  
30x30  
10x30

Spessore  
Thickness  
Épaisseur  
Stärke  
9 mm

Resistenza scivolosità  
Sliding resistance  
Resistance au glissement  
Rutschfestigkeit  
R9

Grado di variazione cromatica  
Degree of colour change  
Degré de variation chromatique  
Grad der Farbabweichung  
V2



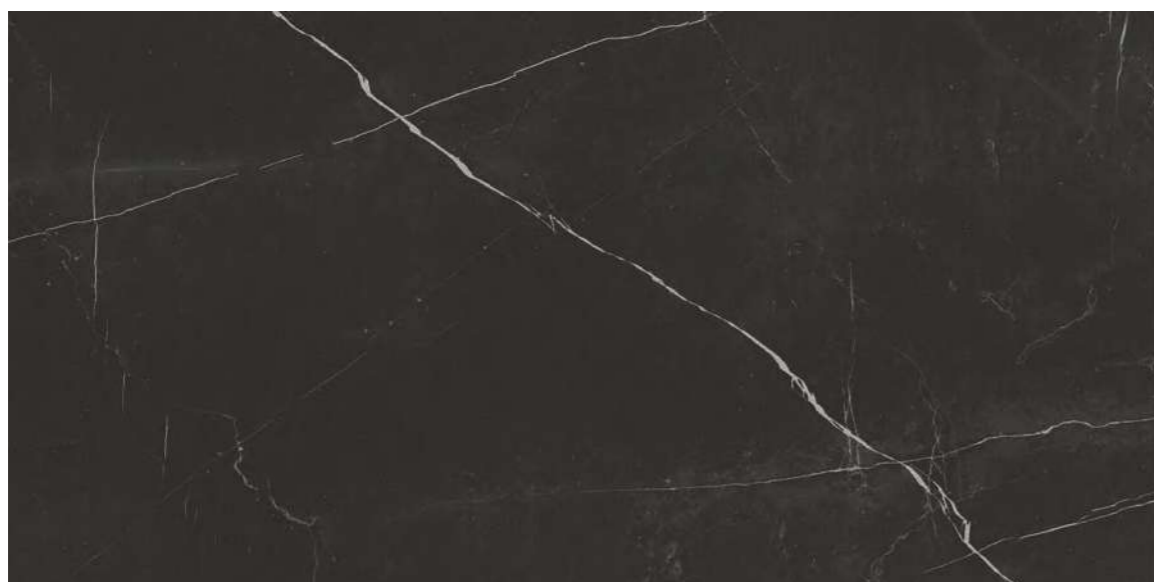

**601258**  
MARQUINIA BLACK NATURALE  
RETTIFICATO 60x120  
Cod. **104** □

**601259**  
MARQUINIA BLACK LAPPATO  
RETTIFICATO 60x120  
Cod. **111** □



**606179**  
MARQUINIA BLACK NATURALE  
RETTIFICATO 60x60  
Cod. **93** □

**606178**  
MARQUINIA BLACK LAPPATO  
RETTIFICATO 60x60  
Cod. **106** □



**490572**  
MARQUINIA BLACK NATURALE  
RETTIFICATO 30x60  
Cod. **85** □

**490573**  
MARQUINIA BLACK LAPPATO  
RETTIFICATO 30x60  
Cod. **100** □

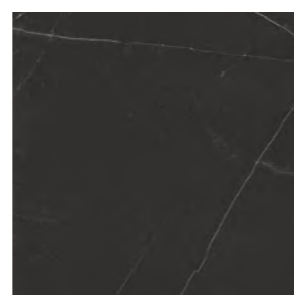

**041054**  
MARQUINIA BLACK NATURALE RETTIFICATO 30x30  
Cod. **91** □

**041055**  
MARQUINIA BLACK LAPPATO RETTIFICATO 30x30  
Cod. **104** □



**103092**  
MARQUINIA BLACK NATURALE  
RETTIFICATO 10x30  
Cod. **111** □

**103093**  
MARQUINIA BLACK LAPPATO  
RETTIFICATO 10x30  
Cod. **139** □

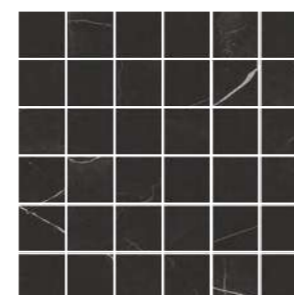

9,30 kg

**041056**  
MARQUINIA BLACK NATURALE  
MOSAICO 5x5 SU RETE 30x30  
Cod. **25** ○

**041057**  
MARQUINIA BLACK LAPPATO  
MOSAICO 5x5 SU RETE 30x30  
Cod. **34** ○

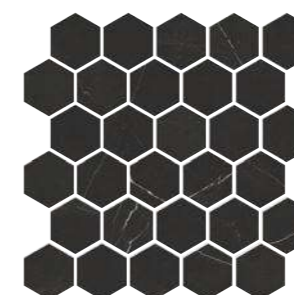

8,90 kg

**041064**  
MARQUINIA BLACK NATURALE  
MOSAICO ESAGONO SU RETE 27x28  
Cod. **47** ○

**041065**  
MARQUINIA BLACK LAPPATO  
MOSAICO ESAGONO SU RETE 27x28  
Cod. **63** ○



6,11 kg

**380252**  
MARQUINIA BLACK NATURALE  
LONDON 5x30  
Cod. **127** ○

**380253**  
MARQUINIA BLACK LUCIDO  
LONDON 5x30  
Cod. **127** ○

#### IMBALLI • PACKAGES • EMBALLAGES • FORMATE

	SCATOLA • BOX • BOITE • KARTON			PALLET • PALLETS • PALETTS • PALETTE		
	pz	mq	kg	box	mq	kg
<b>60x120</b>	2	1,44	30,20	30	43,20	906,00
<b>60x60</b>	3	1,08	22,60	40	43,20	904,00
<b>30x60</b>	6	1,08	22,60	40	43,20	904,00
<b>30x30</b>	11	0,99	21,20	46	45,54	975,00
<b>10x30</b>	20	0,60	12,90	60	36,00	774,00



## marquinia black RETT. LAPPATO

La finitura lappata è consigliata per uso rivestimento o per pavimenti da bagno in ambito residenziale. Nello specifico il tipo di pavimentazione deve essere non soggetta ad eccessive sollecitazioni e mai a diretto contatto con aree esterne. Come si verifica comunemente nelle pietre naturali l'eventuale presenza di puntini sulla superficie o di qualche disuniformità della lucentezza sono da considerare caratteristiche del prodotto derivanti dalla lavorazione a cui viene sottoposto.

The polished finish is recommended for wall coverings or for the floors of residential bathrooms. Specifically, floor coverings in this material must not be subjected to excessively heavy traffic and must never be in direct contact with outdoor areas. As is often the case with natural stones, any spots on the surface or any unevenness in shine are typical characteristics of the product, deriving from the process used.

La finition polie est recommandée pour le revêtement sol et mur des salles de bains résidentielles. Notamment, ce type de carreau au sol ne doit pas être exposé à des contraintes excessives, et il ne doit jamais être en contact direct avec des zones extérieures. Comme cela est souvent le cas pour les pierres naturelles, les micro trous éventuellement présents à la surface du produit ou l'hétérogénéité de son éclat forment des caractéristiques propres au façonnage.

Die polierte Oberfläche wird für Wandverkleidungen und Bodenbeläge in Privatbädern empfohlen. Der Bodenbelag darf keinen starken Beanspruchungen ausgesetzt sein und keinen direkten Kontakt zu Außenbereichen haben. Wie bei Natursteinen üblich, kann die Oberfläche Körnungen oder einen unregelmäßigen Glanz aufweisen. Diese Merkmale sind typische, beabsichtigte Produkteigenschaften, die durch das Bearbeitungsverfahren hervorgerufen werden.

Pezzi speciali • Special trims • Pièces spéciales • Formstücke

Battiscopa

44  
22,40 kg

18  
17,10 kg

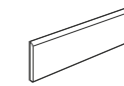

**290673**  
MARQUINIA BLACK NATURALE  
BATTISCOPA 7x30  
Cod. **23** △

**290674**  
MARQUINIA BLACK LAPPATO  
BATTISCOPA 7x30  
Cod. **21** △

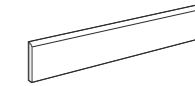

**0290735**  
MARQUINIA BLACK NATURALE  
BATTISCOPA 7x60  
Cod. **121** △

**0290736**  
MARQUINIA BLACK LAPPATO  
BATTISCOPA 7x60  
Cod. **26** △

CARATTERISTICHE DI QUALITÀ Quality characteristics Caractéristiques de qualité Qualitätseigenschaften	NORMA Norm Norme Norme	REQUISITO NORMA Required standards Valeur prescrite selon la norme Normvorgabe	RISULTATO Result Résultat Ergebniss
Assorbimento d'acqua Water absorption of the body Absorption d'eau de support Wasseraufnahme des Scherbens	ISO 10545-3	≤ 0,5	Conforme Conformity Conforme Gemäss
Resistenza a flessione Breaking strenght Résistance à la flexion Biegefestigkeit	ISO 10545-4	≥ 35 N/mm <sup>2</sup>	Conforme Conformity Conforme Gemäss
Resistenza all'abrasione Abrasion resistance Resistance a l'abrasion Abriebbeständigkeit	EN ISO 10545-6	≤ 175 mm <sup>3</sup>	Conforme
Resistenza al gelo Frost resistance Résistance au gel Frostbeständigkeit	ISO 10545-12	Nessun campione deve presentare rotture o alterazioni apprezzabili alla superficie No samples must show ruptures or noticeable surface alteration Aucuns enchantions doit présenter ruptures ou altérations appréciables de la surface Keines der Muster sollte Risse oder sichtbare Fehler der Oberfläche zeigen	Conforme Conformity Conforme Gemäss
Resistenza all'attacco chimico Chemical resistance Résistance à l'attaque chimique Beständigkeit gegen chemikalien	ISO 10545-13	Marquinia Black Rettificato Marquinia Black Lappato	GA GLB GA GLB
Resistenza agli sbalzi termici Thermal shock resistance Resistance aux écarts de température Temperaturwechselbeständigkeit	ISO 10545-5		Conforme Conformity Conforme Gemäss
Resistenza scivolosità Sliding resistance Resistance au glissement Rutschfestigkeit	DIN 51130 R	Marquinia Black Rettificato Marquinia Black Lappato	R9
Lieve variazione Slight variation Légère variation Geringe Abweichung			V2

Aspetto uniforme  
Uniform appearance  
Aspect uniforme  
Einheitliches Aussehen  
**V1**

Lieve variazione  
Slight variation  
Légère variation  
Geringe Abweichung  
**V2**

Significativa variazione  
Significant variation  
Variation important  
Bedeutsam Abweichung  
**V3**

Forte stonizzazione  
Substantial variation  
Effet dénuancé très accentué  
Akzentuierte Variation  
**V4**

**PER UNA POSA OTTIMALE DEL PRODOTTO CONSIGLIAMO SEMPRE DI MESCOLARE ALMENO TRE SCATOLE DI MATERIALE.**

For the best product laying results, material from at least three boxes should be mixed.

Pour une pose excellente, nous recommandons toujours de mélanger le contenu d'au moins trois boîtes.

Für eine optimale Verlegung des Erzeugnisses empfehlen wir stets, mindestens drei Packungen Material anzumischen.



Tipologia  
Type  
Typologie  
Typ  
Gres porcellanato smaltato  
Glazed porcelain  
Grès cérame emaille  
Feinsteinzeug glasiert

Formati  
Sizes  
Formats  
Formate  
30x60  
30x30  
10x30  
5x20

Spessore  
Thickness  
Épaisseur  
Stärke  
10 mm

Resistenza scivolosità  
Sliding resistance  
Resistance au glissement  
Rutschfestigkeit  
R9

Grado di variazione cromatica  
Degree of colour change  
Degré de variation chromatique  
Grad der Farbabweichung  
V2



**490498**  
MET ANTRACITE NAT. 30x60  
Cod. **69** □

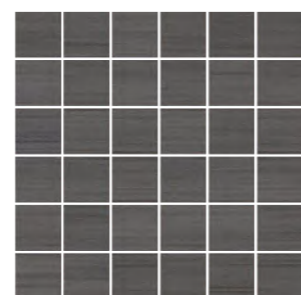

**041014**  
MET ANTRACITE MOSAICO 5x5 SU RETE 30x30  
Cod. **24** ○



12,00 kg



**490499**  
MET BROWN NAT. 30x60  
Cod. **69** □

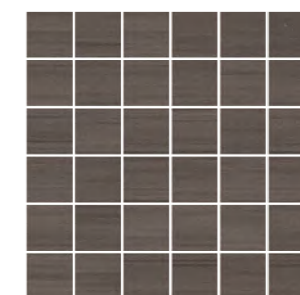

**041010**  
MET BROWN MOSAICO 5x5 SU RETE 30x30  
Cod. **24** ○



12,00 kg

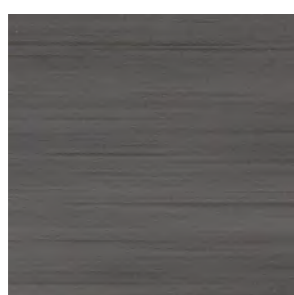

**041008**  
MET ANTRACITE RETTIFICATO 30x30  
Cod. **74** □

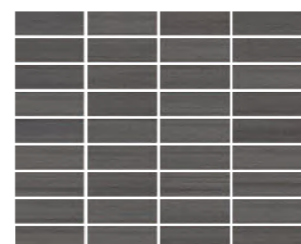

**390477**  
MET ANTRACITE MOSAICO FLOOR SU RETE 25x30  
Cod. **116** ○



10,00 kg



**041004**  
MET BROWN RETTIFICATO 30x30  
Cod. **74** □



**390473**  
MET BROWN MOSAICO FLOOR SU RETE 25x30  
Cod. **116** ○



10,00 kg

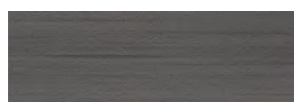

**103084**  
MET ANTRACITE RETTIFICATO 10x30  
Cod. **77** □



**380237**  
MET LISTELLO GREY / ANTRACITE 5x30  
Cod. **123** ○



6,50 kg

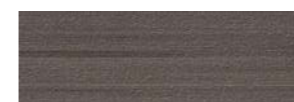

**103080**  
MET BROWN RETTIFICATO 10x30  
Cod. **77** □



**380236**  
MET LISTELLO BROWN / SMOKE 5x30  
Cod. **123** ○



6,50 kg



**050213**  
MET ANTRACITE 5x20  
Cod. **93** □



**050209**  
MET BROWN 5x20  
Cod. **93** □

**IMBALLI • PACKAGES • EMBALLAGES • FORMATE**

	SCATOLA • BOX • BOITE • KARTON			PALLET • PALLETS • PALETTS • PALETTE		
	<i>pz</i>	<i>mq</i>	<i>kg</i>	<i>box</i>	<i>mq</i>	<i>kg</i>
<b>30x60</b>	6	1,08	24,00	40	43,20	960,00
<b>30x30</b>	11	0,99	22,40	46	45,54	1.050,00
<b>10x30</b>	20	0,60	15,00	60	36,00	920,00
<b>5x20</b>	56	0,56	12,30	60	33,60	760,00

**IMBALLI • PACKAGES • EMBALLAGES • FORMATE**

	SCATOLA • BOX • BOITE • KARTON			PALLET • PALLETS • PALETTS • PALETTE		
	<i>pz</i>	<i>mq</i>	<i>kg</i>	<i>box</i>	<i>mq</i>	<i>kg</i>
<b>30x60</b>	6	1,08	24,00	40	43,20	960,00
<b>30x30</b>	11	0,99	22,40	46	45,54	1.050,00
<b>10x30</b>	20	0,60	15,00	60	36,00	920,00
<b>5x20</b>	56	0,56	12,30	60	33,60	760,00



**490496**  
MET GREY NAT. 30x60  
Cod. **69** □

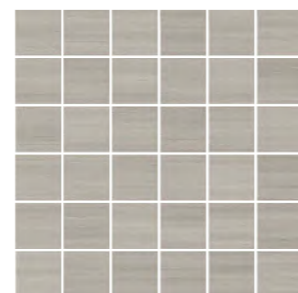

**041011**  
MET GREY MOSAICO 5x5SU RETE 30x30  
Cod. **24** ○



**490497**  
MET SMOKE NAT. 30x60  
Cod. **69** □

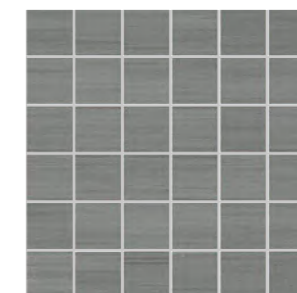

**041013**  
MET SMOKE MOSAICO 5x5 SU RETE 30x30  
Cod. **24** ○



**041005**  
MET GREY RETTIFICATO 30x30  
Cod. **74** □

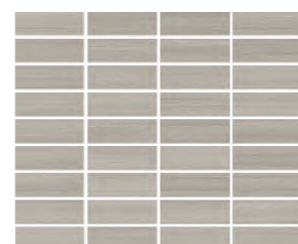

**390474**  
MET GREY MOSAICO FLOOR SU RETE 25x30  
Cod. **116** ○



**041007**  
MET SMOKE RETTIFICATO 30x30  
Cod. **74** □

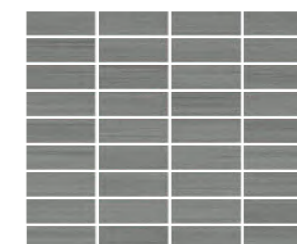

**390476**  
MET SMOKE MOSAICO FLOOR SU RETE 25x30  
Cod. **116** ○

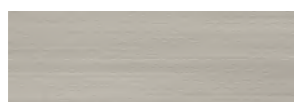

**103081**  
MET GREY RETTIFICATO 10x30  
Cod. **77** □



**380237**  
MET LISTELLO GREY / ANTRACITE 5x30  
Cod. **123** ○

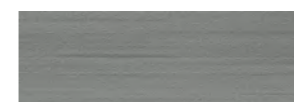

**103083**  
MET SMOKE RETTIFICATO 10x30  
Cod. **77** □



**380236**  
MET LISTELLO BROWN / SMOKE 5x30  
Cod. **123** ○



**050210**  
MET GREY 5x20  
Cod. **93** □



**050212**  
MET SMOKE 5x20  
Cod. **93** □

IMBALLI • PACKAGES • EMBALLAGES • FORMATE

	SCATOLA • BOX • BOITE • KARTON			PALLET • PALLETS • PALETTS • PALETTE		
	<i>pz</i>	<i>mq</i>	<i>kg</i>	<i>box</i>	<i>mq</i>	<i>kg</i>
<b>30x60</b>	6	1,08	24,00	40	43,20	960,00
<b>30x30</b>	11	0,99	25,00	40	39,60	1.020,00
<b>10x30</b>	20	0,60	15,00	60	36,00	920,00
<b>5x20</b>	56	0,56	12,30	60	33,60	760,00

IMBALLI • PACKAGES • EMBALLAGES • FORMATE

	SCATOLA • BOX • BOITE • KARTON			PALLET • PALLETS • PALETTS • PALETTE		
	<i>pz</i>	<i>mq</i>	<i>kg</i>	<i>box</i>	<i>mq</i>	<i>kg</i>
<b>30x60</b>	6	1,08	24,00	40	43,20	960,00
<b>30x30</b>	11	0,99	25,00	40	39,60	1.020,00
<b>10x30</b>	20	0,60	15,00	60	36,00	920,00
<b>5x20</b>	56	0,56	12,30	60	33,60	760,00



**490495**  
MET WHITE NAT. 30x60  
Cod. **69** □



**041006**  
MET WHITE RETTIFICATO 30x30  
Cod. **74** □



**103082**  
MET WHITE RETTIFICATO 10x30  
Cod. **77** □



**050211**  
MET WHITE 5x20  
Cod. **93** □



**041012**  
MET WHITE MOSAICO 5x5 SU RETE 30x30  
Cod. **24** ○

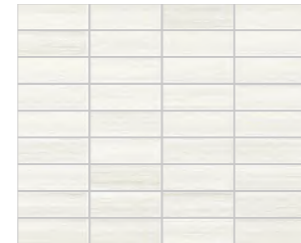

**390475**  
MET WHITE MOSAICO FLOOR SU RETE 25x30  
Cod. **116** ○



**380237**  
MET LISTELLO GREY / ANTRACITE 5x30  
Cod. **123** ○

**IMBALLI • PACKAGES • EMBALLAGES • FORMATE**

	SCATOLA • BOX • BOITE • KARTON			PALLET • PALLETS • PALETTS • PALETTE		
	pz	mq	kg	box	mq	kg
<b>30x60</b>	6	1,08	24,00	40	43,20	960,00
<b>30x30</b>	11	0,99	22,40	46	45,54	1.050,00
<b>10x30</b>	20	0,60	15,00	60	36,00	920,00
<b>5x20</b>	56	0,56	12,30	60	33,60	760,00

Pezzi speciali • Special trims • Pièces spéciales • Formstücke

Battiscopa	40 9,00 kg	20 9,00 kg
------------	---------------	---------------

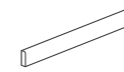

**290638**  
MET ANTRACITE BATTISCOPA 5x30  
Cod. **116** △

**290634**  
MET BROWN BATTISCOPA 5x30  
Cod. **116** △

**290635**  
MET GREY BATTISCOPA 5x30  
Cod. **116** △

**290637**  
MET SMOKE BATTISCOPA 5x30  
Cod. **116** △

**290636**  
MET WHITE BATTISCOPA 5x30  
Cod. **116** △

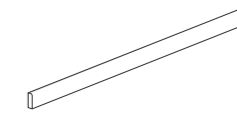

**290643**  
MET ANTRACITE BATTISCOPA 5x60  
Cod. **121** △

**290639**  
MET BROWN BATTISCOPA 5x60  
Cod. **121** △

**290640**  
MET GREY BATTISCOPA 5x60  
Cod. **121** △

**290642**  
MET SMOKE BATTISCOPA 5x60  
Cod. **121** △

**290641**  
MET WHITE BATTISCOPA 5x60  
Cod. **121** △

CARATTERISTICHE DI QUALITÀ Quality characteristics Caractéristiques de qualité Qualitätseigenschaften	NORMA Norm Norme Norme	REQUISITO NORMA Required standards Valeur prescrite selon la norme Normvorgabe	RISULTATO Result Résultat Ergebniss
Assorbimento d'acqua Water absorption of the body Absorption d'eau de support Wasseraufnahme des Scherbens	ISO 10545-3	≤ 0,5	Conforme Conformity Conforme Gemäss
Resistenza a flessione Breaking strength Résistance à la flexion Biegefestigkeit	ISO 10545-4	≥ 35 N/mm <sup>2</sup>	Conforme Conformity Conforme Gemäss
Resistenza all'abrasione Abrasion resistance Résistance à l'abrasion Abriebbeständigkeit	EN ISO 10545-7	White - Grey	PEI IV
		Smoke - Brown - Antracite	PEI III
Resistenza al gelo Frost resistance Résistance au gel Frostbeständigkeit	ISO 10545-12	Nessun campione deve presentare rotture o alterazioni apprezzabili alla superficie No samples must show ruptures or noticeable surface alteration Aucuns enchantions doit présenter ruptures ou altérations appréciables de la surface Keines der Muster sollte Risse oder sichtbare Fehler der Oberfläche zeigen	Conforme Conformity Conforme Gemäss
Resistenza all'attacco chimico Chemical resistance Résistance à l'attaque chimique Beständigkeit gegen chemikalien	ISO 10545-13		GA GLA
Resistenza agli sbalzi termici Thermal shock resistance Resistance aux écarts de température Temperaturwechselbeständigkeit	ISO 10545-5		Conforme Conformity Conforme Gemäss
Resistenza scivolosità Sliding resistance Resistance au glissement Rutschfestigkeit	DIN 51130 R		R9
Coefficiente d'attrito dinamico Wet dynamic coefficient of friction Coefficient de friction dynamique Reibungskoeffizient Schlupfrigkeit (in Bewegung)	Bot 3000 E	DCOF ≥ 0,42	> 0,42
Lieve variazione Slight variation Légère variation Geringe Abweichung			V2

<b>V1</b> Aspetto uniforme Uniform appearance Aspect uniforme Einheitliches Aussehen	<b>V2</b> Lieve variazione Slight variation Légère variation Geringe Abweichung	<b>V3</b> Significativa variazione Significant variation Variation important Bedeutsam Abweichung	<b>V4</b> Forte stonalizzazione Substantial variation Effet dénuancé très accentué Akzentuierte Variation
--	---	---	---

**PER UNA POSA OTTIMALE DEL PRODOTTO CONSIGLIAMO SEMPRE DI MESCOLARE ALMENO TRE SCATOLE DI MATERIALE.**

For the best product laying results, material from at least three boxes should be mixed.  
Pour une pose excellente, nous recommandons toujours de mélanger le contenu d'au moins trois boîtes.  
Für eine optimale Verlegung des Erzeugnisses empfehlen wir stets, mindestens drei Packungen Material anzumischen.



Tipologia  
Type  
Typologie  
Typ  
Gres porcellanato smaltato  
Glazed porcelain  
Grès cérame emaille  
Feinsteinzeug glasiert

Formati  
Sizes  
Formats  
Formate  
60x120  
60x60  
30x60  
10x30

Spessore  
Thickness  
Épaisseur  
Stärke  
9 mm

Resistenza scivolosità  
Sliding resistance  
Resistance au glissement  
Rutschfestigkeit  
R9

Grado di variazione cromatica  
Degree of colour change  
Degré de variation chromatique  
Grad der Farbabweichung  
V3



**601343**  
MIDNIGHT BLUE NATURALE  
RETTIFICATO 60x120  
Cod. **94** □

**601344**  
MIDNIGHT BLUE LAPPATO  
RETTIFICATO 60x120  
Cod. **103** □



**606298**  
MIDNIGHT BLUE NATURALE  
RETTIFICATO 60x60  
Cod. **79** □

**606299**  
MIDNIGHT BLUE LAPPATO  
RETTIFICATO 60x60  
Cod. **93** □



**490875**  
MIDNIGHT BLUE NATURALE  
RETTIFICATO 30x60  
Cod. **76** □

**490876**  
MIDNIGHT BLUE LAPPATO  
RETTIFICATO 30x60  
Cod. **85** □



**103169**  
MIDNIGHT BLUE NATURALE  
RETTIFICATO 10x30  
Cod. **77** □

**103170**  
MIDNIGHT BLUE LAPPATO  
RETTIFICATO 10x30  
Cod. **93** □

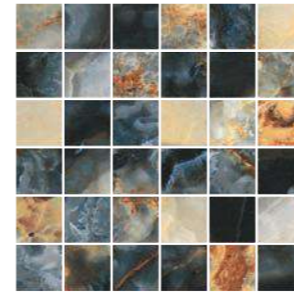

**041633**  
MIDNIGHT BLUE NATURALE  
MOSAICO 5x5 SU RETE 30x30  
Cod. **24** ○

**041634**  
MIDNIGHT BLUE LAPPATO  
MOSAICO 5x5 SU RETE 30x30  
Cod. **31** ○



9,30 kg



**041549**  
MIDNIGHT BLUE NATURALE  
MOSAICO ESAGONO SU RETE 27x28  
Cod. **136** ○

**041550**  
MIDNIGHT BLUE LAPPATO  
MOSAICO ESAGONO SU RETE 27x28  
Cod. **49** ○



8,90 kg



**041517**  
MIDNIGHT BLUE NATURALE  
MOSAICO HB SU RETE 28x32  
Cod. **45** ○

**041518**  
MIDNIGHT BLUE LAPPATO  
MOSAICO HB SU RETE 28x32  
Cod. **48** ○



10,20 kg



**041581**  
MIDNIGHT BLUE NATURALE  
MOSAICO ESAGONO INTARSIO SU RETE 20,7x27  
Cod. **57** ○

**041582**  
MIDNIGHT BLUE LAPPATO  
MOSAICO ESAGONO INTARSIO SU RETE 20,7x27  
Cod. **72** ○



6,50 kg



**041565**  
MIDNIGHT BLUE NATURALE  
MOSAICO FANCY SU RETE 24x30  
Cod. **51** ○

**041566**  
MIDNIGHT BLUE LAPPATO  
MOSAICO FANCY SU RETE 24x30  
Cod. **71** ○



8,90 kg

IMBALLI • PACKAGES • EMBALLAGES • FORMATE

	SCATOLA • BOX • BOITE • KARTON			PALLET • PALLETS • PALETTS • PALETTE		
	pz	mq	kg	box	mq	kg
<b>60x120</b>	2	1,44	30,20	30	43,20	906,00
<b>60x60</b>	3	1,08	22,60	40	43,20	904,00
<b>30x60</b>	6	1,08	22,60	40	43,20	975,00
<b>10x30</b>	20	0,60	12,90	60	36,00	774,00



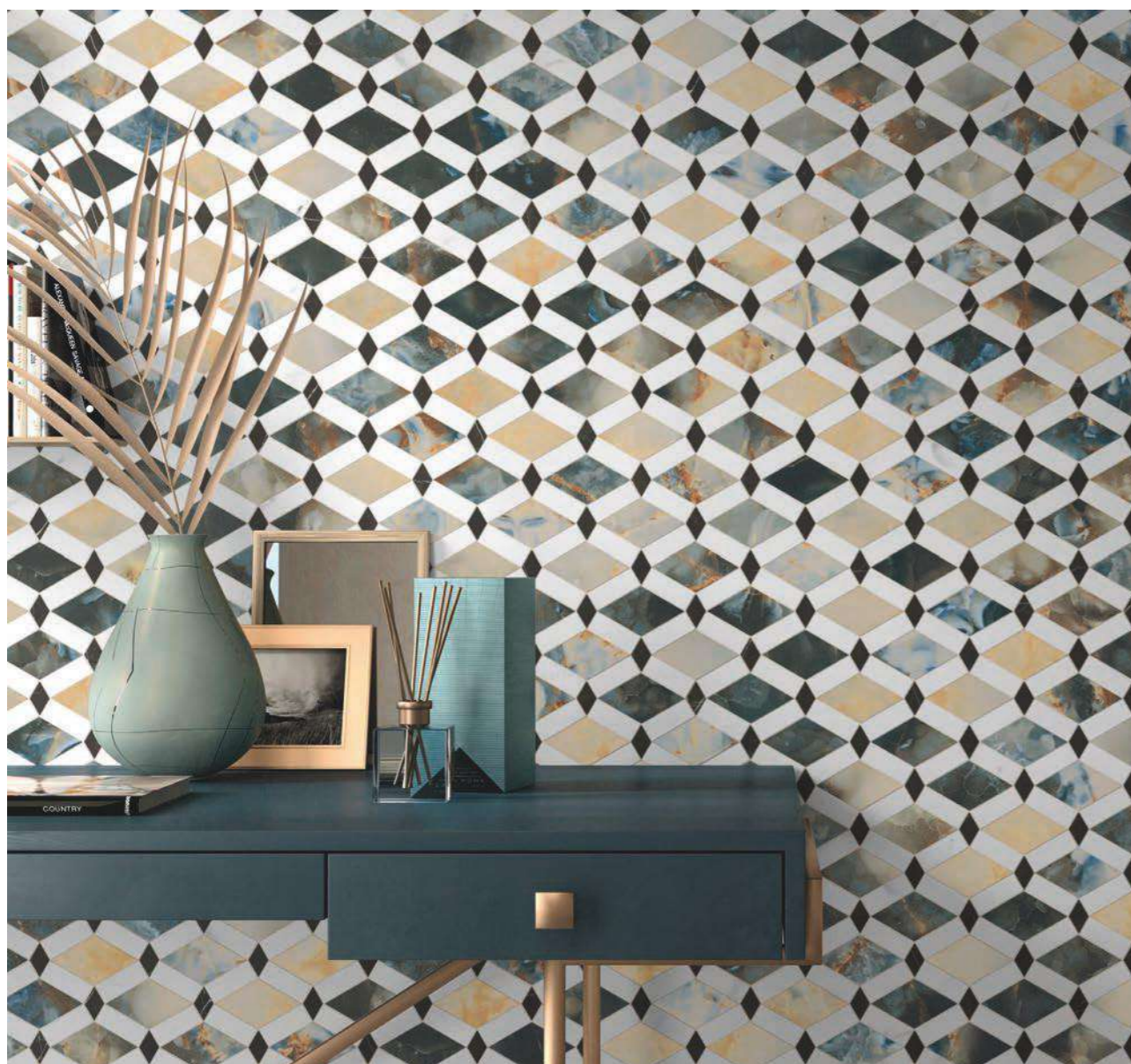

## midnight blue RETT. LAPPATO

La finitura lappata è consigliata per uso rivestimento o per pavimenti da bagno in ambito residenziale. Nello specifico il tipo di pavimentazione deve essere non soggetta ad eccessive sollecitazioni e mai a diretto contatto con aree esterne. Come si verifica comunemente nelle pietre naturali l'eventuale presenza di puntini sulla superficie o di qualche disuniformità della lucentezza sono da considerare caratteristiche del prodotto derivanti dalla lavorazione a cui viene sottoposto.

The polished finish is recommended for wall coverings or for the floors of residential bathrooms. Specifically, floor coverings in this material must not be subjected to excessively heavy traffic and must never be in direct contact with outdoor areas. As is often the case with natural stones, any spots on the surface or any unevenness in shine are typical characteristics of the product, deriving from the process used.

La finition polie est recommandée pour le revêtement sol et mur des salles de bains résidentielles. Notamment, ce type de carreau au sol ne doit pas être exposé à des contraintes excessives, et il ne doit jamais être en contact direct avec des zones extérieures. Comme cela est souvent le cas pour les pierres naturelles, les micro trous éventuellement présents à la surface du produit ou l'hétérogénéité de son éclat forment des caractéristiques propres au façonnage.

Die polierte Oberfläche wird für Wandverkleidungen und Bodenbeläge in Privatbädern empfohlen. Der Bodenbelag darf keinen starken Beanspruchungen ausgesetzt sein und keinen direkten Kontakt zu Außenbereichen haben. Wie bei Natursteinen üblich, kann die Oberfläche Körnungen oder einen unregelmäßigen Glanz aufweisen. Diese Merkmale sind typische, beabsichtigte Produkteigenschaften, die durch das Bearbeitungsverfahren hervorgerufen werden.

Pezzi speciali • Special trims • Pièces spéciales • Formstücke

Battiscopa	44 22,40 kg	18 17,10 kg
	<b>290886</b> MIDNIGHT BLUE NATURALE BATTISCOPA 7x30 Cod. <b>116</b> △	<b>290902</b> MIDNIGHT BLUE NATURALE BATTISCOPA 7x60 Cod. <b>121</b> △
	<b>290887</b> MIDNIGHT BLUE LAPPATO BATTISCOPA 7x30 Cod. <b>22</b> △	<b>290903</b> MIDNIGHT BLUE LAPPATO BATTISCOPA 7x60 Cod. <b>26</b> △

CARATTERISTICHE DI QUALITÀ Quality characteristics Caractéristiques de qualité Qualitätseigenschaften	NORMA Norm Norme Norme	REQUISITO NORMA Required standards Valeur prescrite selon la norme Normvorgabe	RISULTATO Result Résultat Ergebniss
Assorbimento d'acqua Water absorption of the body Absorption d'eau de support Wasseraufnahme des Scherbens	ISO 10545-3	≤ 0,5	Conforme Conformity Conforme Gemäss
Resistenza a flessione Breaking strenght Résistance à la flexion Biegefestigkeit	ISO 10545-4	≥ 35 N/mm <sup>2</sup>	Conforme Conformity Conforme Gemäss
Resistenza all'abrasione Abrasion resistance Résistance à l'abrasion Abriebbeständigkeit	ISO 10545-7	MIDNIGHT BLUE Rettificato	PEI IV
Resistenza al gelo Frost resistance Résistance au gel Frostbeständigkeit	ISO 10545-12	Nessun campione deve presentare rotture o alterazioni apprezzabili alla superficie No samples must show ruptures or noticeable surface alteration Aucuns enchantions doit présenter ruptures ou altérations appréciables de la surface Keines der Muster sollte Risse oder sichtbare Fehler der Oberfläche zeigen	Conforme Conformity Conforme Gemäss
Resistenza all'attacco chimico Chemical resistance Résistance à l'attaque chimique Beständigkeit gegen chemikalien	ISO 10545-13	MIDNIGHT BLUE Naturale MIDNIGHT BLUE Lappato	GA GLA GA GLB
Resistenza agli sbalzi termici Thermal shock resistance Résistance aux écarts de température Temperaturwechselbeständigkeit	ISO 10545-5		Conforme Conformity Conforme Gemäss
Resistenza scivolosità Sliding resistance Résistance au glissement Rutschfestigkeit	DIN 51130 R		R9
Significativa variazione Significant variation Variation important Bedeutsam Abweichung		MIDNIGHT BLUE Rettificato	V3

**V1**  
Aspetto uniforme  
Uniform appearance  
Aspect uniforme  
Einheitliches Aussehen

**V2**  
Lieve variazione  
Slight variation  
Légère variation  
Geringe Abweichung

**V3**  
Significativa variazione  
Significant variation  
Variation important  
Bedeutsam Abweichung

**V4**  
Forte stonazione  
Substantial variation  
Effet dénuancé très accentué  
Akzentuierte Variation

**PER UNA POSA OTTIMALE DEL PRODOTTO CONSIGLIAMO SEMPRE DI MESCOLARE ALMENO TRE SCATOLE DI MATERIALE.**

For the best product laying results, material from at least three boxes should be mixed.

Pour une pose excellente, nous recommandons toujours de mélanger le contenu d'au moins trois boîtes.

Für eine optimale Verlegung des Erzeugnisses empfehlen wir stets, mindestens drei Packungen Material anzumischen.



Tipologia  
Type  
Typologie  
Typ  
Gres porcellanato smaltato  
Glazed porcelain  
Grès cérame emaille  
Feinsteinzeug glasiert

Formati R10 A+B  
Sizes  
Formats  
Formate  
60x120  
20x120  
90x90 (10 mm)  
60x60  
30x60  
10x30  
5x20  
15x17 Esagona

Spessore  
Thickness  
Épaisseur  
Stärke  
9 mm  
10 mm (90x90)  
20 mm

Resistenza scivolosità  
Sliding resistance  
Resistance au glissement  
Rutschfestigkeit  
R10 / A+B  
R11 / A+B+C

Grado di variazione cromatica  
Degree of colour change  
Degré de variation chromatique  
Grad der Farbabweichung  
V3

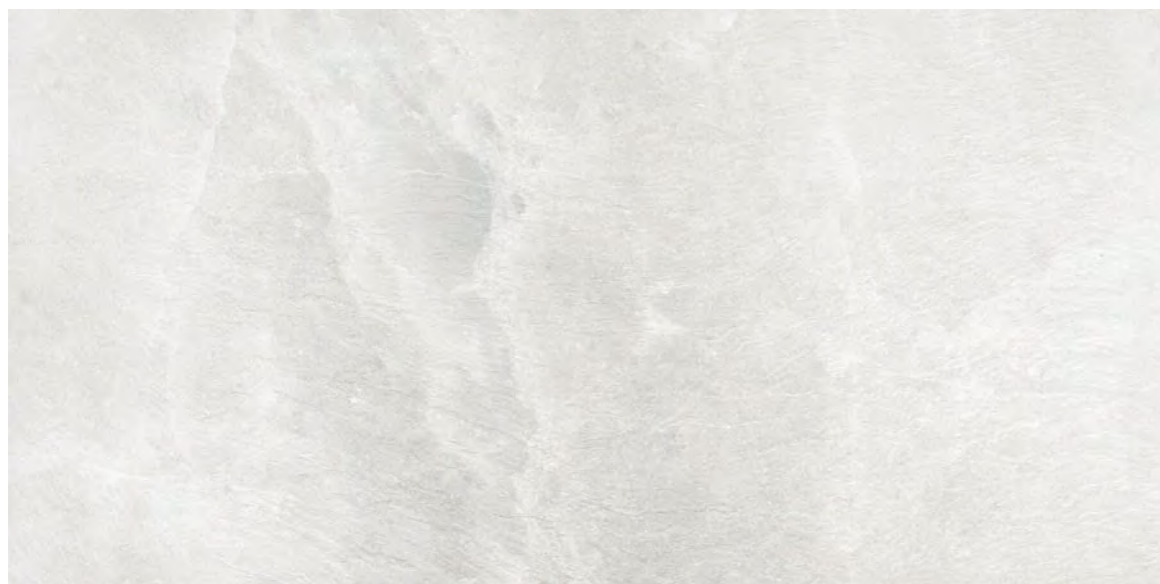

**601305**  
MONOLITH WHITE RETTIFICATO 60x120  
Cod. **94** □



**201237**  
MONOLITH WHITE RETTIFICATO 20x120  
Cod. **111** □

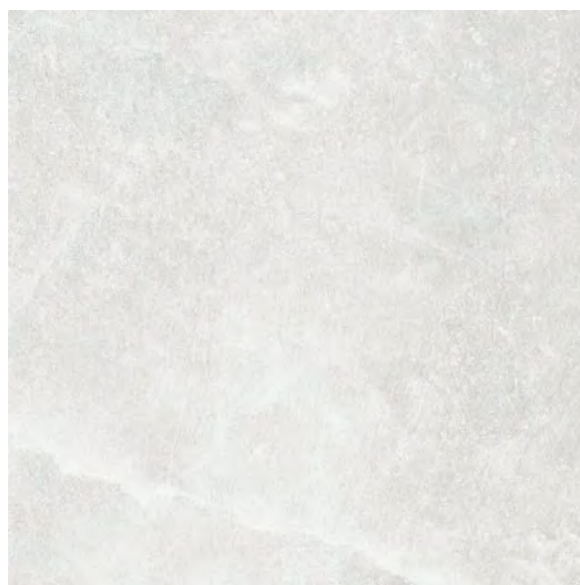

**606253**  
MONOLITH WHITE RETTIFICATO 60x60  
Cod. **79** □

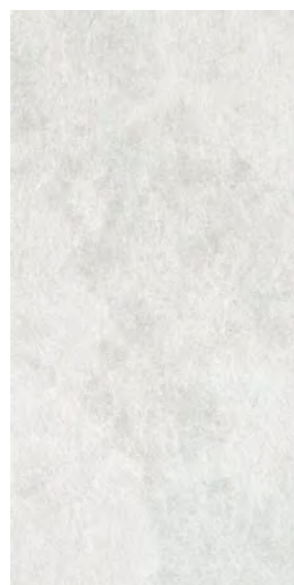

**490782**  
MONOLITH WHITE RETTIFICATO 30x60  
Cod. **76** □



**103141**  
MONOLITH WHITE RETTIFICATO 10x30  
Cod. **77** □



**050235**  
MONOLITH WHITE 5x20  
Cod. **93** □

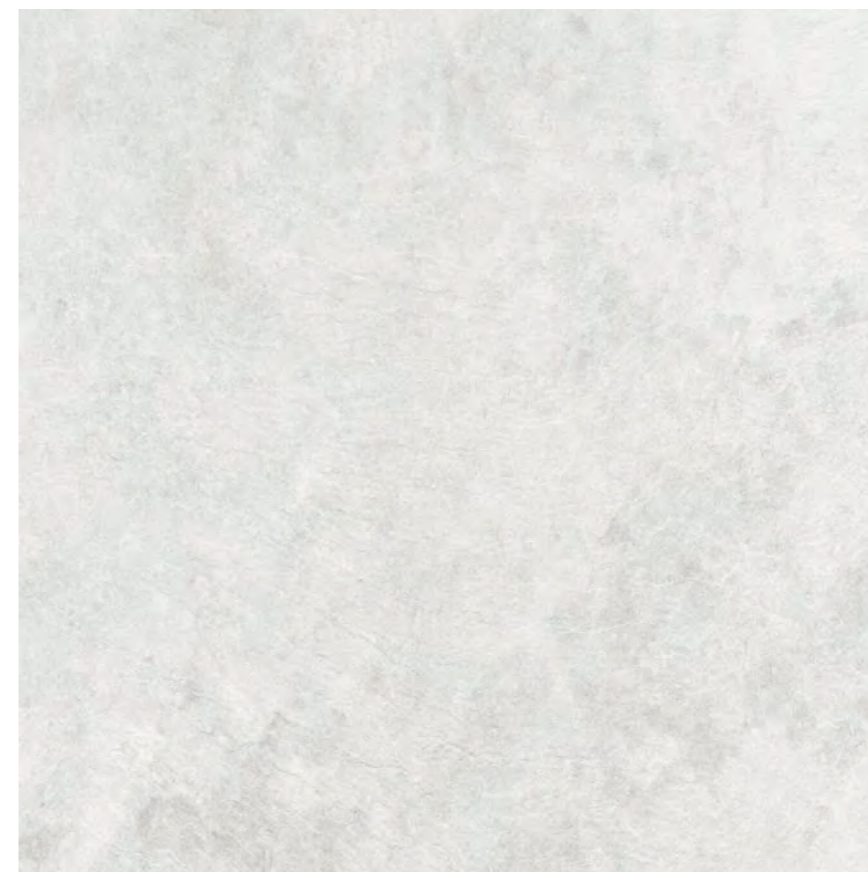

**909051**  
MONOLITH WHITE RETTIFICATO 90x90  
Cod. **97** □



**230334**  
MONOLITH WHITE RETTIFICATO  
ESAGONA 15x17  
Cod. **113** □

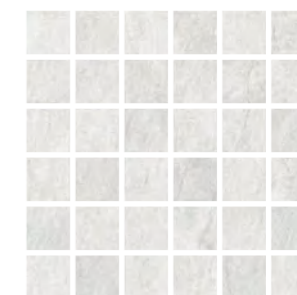

9,12 kg

**041384**  
MONOLITH WHITE  
MOSAICO 5x5 SU RETE 30x30  
Cod. **24** ○



7,00 kg

**041389**  
MONOLITH WHITE  
MOSAICO 3D SQUARE SU RETE 30,6x28,4  
Cod. **43** ○

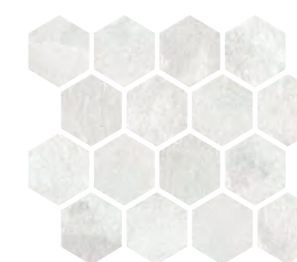

7,90 kg

**041397**  
MONOLITH WHITE  
MOSAICO ESAGONO SU RETE 30x26  
Cod. **128** ○



10,30 kg

**041415**  
MONOLITH WHITE  
MOSAICO ARABESQUE SU RETE 30x30  
Cod. **57** ○

**IMBALLI • PACKAGES • EMBALLAGES • FORMATE**

	SCATOLA • BOX • BOITE • KARTON			PALLET • PALLETS • PALETTS • PALETTE		
	<i>pz</i>	<i>mq</i>	<i>kg</i>	<i>box</i>	<i>mq</i>	<i>kg</i>
<b>60x120</b>	2	1,44	28,70	30	43,20	861,00
<b>20x120</b>	4	0,96	19,10	30	28,80	574,00
<b>90x90</b>	2	1,62	33,50	20	32,40	670,00
<b>60x60</b>	3	1,08	21,30	40	43,20	850,00
<b>30x60</b>	6	1,08	21,20	40	43,20	850,00
<b>10x30</b>	20	0,60	12,50	60	36,00	750,00
<b>5x20</b>	56	0,56	11,70	60	33,60	700,00
<b>15x17 Esagona</b>	30	0,57	12,10	56	31,92	678,00



**601309**  
MONOLITH TAUPE RETTIFICATO 60x120  
Cod. **94** □



**201241**  
MONOLITH TAUPE RETTIFICATO 20x120  
Cod. **111** □



**606257**  
MONOLITH TAUPE RETTIFICATO 60x60  
Cod. **79** □



**490786**  
MONOLITH TAUPE RETTIFICATO 30x60  
Cod. **76** □



**103145**  
MONOLITH TAUPE RETTIFICATO 10x30  
Cod. **77** □



**050239**  
MONOLITH TAUPE 5x20  
Cod. **93** □



**909055**  
MONOLITH TAUPE RETTIFICATO 90x90  
Cod. **97** □



**230338**  
MONOLITH TAUPE RETTIFICATO  
ESAGONA 15x17  
Cod. **113** □



9,12 kg

**041388**  
MONOLITH TAUPE  
MOSAICO 5x5 SU RETE 30x30  
Cod. **24** ○



7,00 kg

**041393**  
MONOLITH TAUPE  
MOSAICO 3D SQUARE SU RETE 30,6x28,4  
Cod. **43** ○



7,90 kg

**041401**  
MONOLITH TAUPE  
MOSAICO ESAGONO SU RETE 30x26  
Cod. **128** ○



10,30 kg

**041408**  
MONOLITH TAUPE  
MOSAICO ARABESQUE SU RETE 30x30  
Cod. **57** ○

**IMBALLI • PACKAGES • EMBALLAGES • FORMATE**

	SCATOLA • BOX • BOITE • KARTON			PALLET • PALLETS • PALETTS • PALETTE		
	<i>pz</i>	<i>mq</i>	<i>kg</i>	<i>box</i>	<i>mq</i>	<i>kg</i>
<b>60x120</b>	2	1,44	28,70	30	43,20	861,00
<b>20x120</b>	4	0,96	19,10	30	28,80	574,00
<b>90x90</b>	2	1,62	33,50	20	32,40	670,00
<b>60x60</b>	3	1,08	21,30	40	43,20	850,00
<b>30x60</b>	6	1,08	21,20	40	43,20	850,00
<b>10x30</b>	20	0,60	12,50	60	36,00	750,00
<b>5x20</b>	56	0,56	11,70	60	33,60	700,00
<b>15x17 Esagona</b>	30	0,57	12,10	56	31,92	678,00



**601308**  
MONOLITH GREY RETTIFICATO 60x120  
Cod. **94** □



**201240**  
MONOLITH GREY RETTIFICATO 20x120  
Cod. **111** □



**606256**  
MONOLITH GREY RETTIFICATO 60x60  
Cod. **79** □



**490785**  
MONOLITH GREY RETTIFICATO 30x60  
Cod. **76** □



**103144**  
MONOLITH GREY RETTIFICATO 10x30  
Cod. **77** □



**050238**  
MONOLITH GREY 5x20  
Cod. **93** □



**909054**  
MONOLITH GREY RETTIFICATO 90x90  
Cod. **97** □

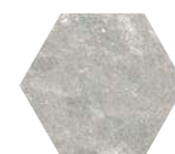

**230337**  
MONOLITH GREY RETTIFICATO  
ESAGONA 15x17  
Cod. **113** □



**041387**  
MONOLITH GREY  
MOSAICO 5x5 SU RETE 30x30  
Cod. **24** ○



9,12 kg



**041392**  
MONOLITH GREY  
MOSAICO 3D SQUARE SU RETE 30,6x28,4  
Cod. **43** ○



7,00 kg



**041400**  
MONOLITH GREY  
MOSAICO ESAGONO SU RETE 30x26  
Cod. **128** ○



7,90 kg



**041407**  
MONOLITH GREY  
MOSAICO ARABESQUE SU RETE 30x30  
Cod. **57** ○



10,30 kg

**IMBALLI • PACKAGES • EMBALLAGES • FORMATE**

	SCATOLA • BOX • BOITE • KARTON			PALLET • PALLETS • PALETTS • PALETTE		
	<i>pz</i>	<i>mq</i>	<i>kg</i>	<i>box</i>	<i>mq</i>	<i>kg</i>
<b>60x120</b>	2	1,44	28,70	30	43,20	861,00
<b>20x120</b>	4	0,96	19,10	30	28,80	574,00
<b>90x90</b>	2	1,62	33,50	20	32,40	670,00
<b>60x60</b>	3	1,08	21,30	40	43,20	850,00
<b>30x60</b>	6	1,08	21,20	40	43,20	850,00
<b>10x30</b>	20	0,60	12,50	60	36,00	750,00
<b>5x20</b>	56	0,56	11,70	60	33,60	700,00
<b>15x17 Esagona</b>	30	0,57	12,10	56	31,92	678,00



**601306**  
MONOLITH MUD RETTIFICATO 60x120  
Cod. **94** □



**201238**  
MONOLITH MUD RETTIFICATO 20x120  
Cod. **111** □



**606254**  
MONOLITH MUD RETTIFICATO 60x60  
Cod. **79** □



**490783**  
MONOLITH MUD RETTIFICATO 30x60  
Cod. **76** □



**103142**  
MONOLITH MUD RETTIFICATO 10x30  
Cod. **77** □



**050236**  
MONOLITH MUD 5x20  
Cod. **93** □



**909052**  
MONOLITH MUD RETTIFICATO 90x90  
Cod. **97** □

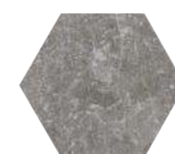

**230335**  
MONOLITH MUD RETTIFICATO  
ESAGONA 15x17  
Cod. **113** □

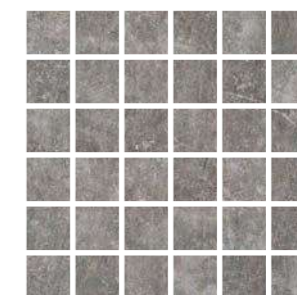

**041385**  
MONOLITH MUD  
MOSAICO 5x5 SU RETE 30x30  
Cod. **24** ○



9,12 kg



**041390**  
MONOLITH MUD  
MOSAICO 3D SQUARE SU RETE 30,6x28,4  
Cod. **43** ○



7,00 kg



**041398**  
MONOLITH MUD  
MOSAICO ESAGONO SU RETE 30x26  
Cod. **128** ○



7,90 kg



**041405**  
MONOLITH MUD  
MOSAICO ARABESQUE SU RETE 30x30  
Cod. **57** ○



10,30 kg

**IMBALLI • PACKAGES • EMBALLAGES • FORMATE**

	SCATOLA • BOX • BOITE • KARTON			PALLET • PALLETS • PALETTS • PALETTE		
	<i>pz</i>	<i>mq</i>	<i>kg</i>	<i>box</i>	<i>mq</i>	<i>kg</i>
<b>60x120</b>	2	1,44	28,70	30	43,20	861,00
<b>20x120</b>	4	0,96	19,10	30	28,80	574,00
<b>90x90</b>	2	1,62	33,50	20	32,40	670,00
<b>60x60</b>	3	1,08	21,30	40	43,20	850,00
<b>30x60</b>	6	1,08	21,20	40	43,20	850,00
<b>10x30</b>	20	0,60	12,50	60	36,00	750,00
<b>5x20</b>	56	0,56	11,70	60	33,60	700,00
<b>15x17 Esagona</b>	30	0,57	12,10	56	31,92	678,00



**601307**  
MONOLITH BLACK RETTIFICATO 60x120  
Cod. **94** □



**201239**  
MONOLITH BLACK RETTIFICATO 20x120  
Cod. **111** □



**606255**  
MONOLITH BLACK RETTIFICATO 60x60  
Cod. **79** □



**490784**  
MONOLITH BLACK RETTIFICATO 30x60  
Cod. **76** □



**103143**  
MONOLITH BLACK RETTIFICATO 10x30  
Cod. **77** □



**050237**  
MONOLITH BLACK 5x20  
Cod. **93** □



**909053**  
MONOLITH BLACK RETTIFICATO 90x90  
Cod. **97** □

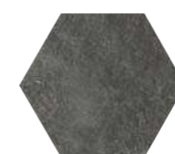

**230336**  
MONOLITH BLACK RETTIFICATO  
ESAGONA 15x17  
Cod. **113** □

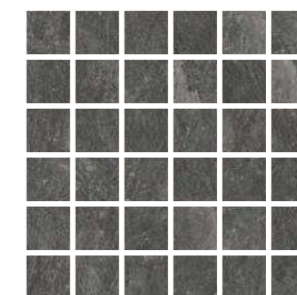

**041386**  
MONOLITH BLACK  
MOSAICO 5x5 SU RETE 30x30  
Cod. **24** ○



9,12 kg



**041391**  
MONOLITH BLACK  
MOSAICO 3D SQUARE SU RETE 30,6x28,4  
Cod. **43** ○



7,00 kg



**041399**  
MONOLITH BLACK  
MOSAICO ESAGONO SU RETE 30x26  
Cod. **128** ○



7,90 kg



**041406**  
MONOLITH BLACK  
MOSAICO ARABESQUE SU RETE 30x30  
Cod. **57** ○



10,30 kg

**IMBALLI • PACKAGES • EMBALLAGES • FORMATE**

	SCATOLA • BOX • BOITE • KARTON			PALLET • PALLETS • PALETTS • PALETTE		
	<i>pz</i>	<i>mq</i>	<i>kg</i>	<i>box</i>	<i>mq</i>	<i>kg</i>
<b>60x120</b>	2	1,44	28,70	30	43,20	861,00
<b>20x120</b>	4	0,96	19,10	30	28,80	574,00
<b>90x90</b>	2	1,62	33,50	20	32,40	670,00
<b>60x60</b>	3	1,08	21,30	40	43,20	850,00
<b>30x60</b>	6	1,08	21,20	40	43,20	850,00
<b>10x30</b>	20	0,60	12,50	60	36,00	750,00
<b>5x20</b>	56	0,56	11,70	60	33,60	700,00
<b>15x17 Esagona</b>	30	0,57	12,10	56	31,92	678,00



20 mm

601310  
MONOLITH WHITE 2 CM RETTIFICATO 60x120  
Cod. 141 □



20 mm

601314  
MONOLITH TAUPE 2 CM RETTIFICATO 60x120  
Cod. 141 □



20 mm

601313  
MONOLITH GREY 2 CM RETTIFICATO 60x120  
Cod. 141 □



20 mm

601311  
MONOLITH MUD 2 CM RETTIFICATO 60x120  
Cod. 141 □



20 mm

601312  
MONOLITH BLACK 2 CM RETTIFICATO 60x120  
Cod. 141 □

IMBALLI • PACKAGES • EMBALLAGES • FORMATE









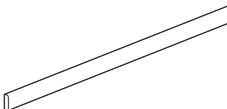
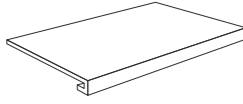
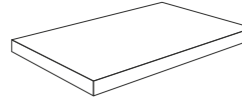
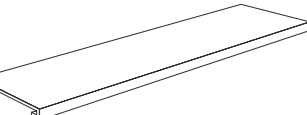
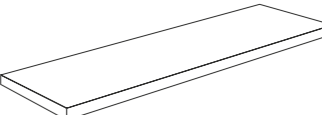

	SCATOLA • BOX • BOITE • KARTON			PALLET • PALLETS • PALETTS • PALETTE		
	pz	mq	kg	box	mq	kg
60x120 (20mm)	1	0,72	30,60	36	25,92	1.125,00





Pezzi speciali • Special trims • Pièces spéciales • Formstücke

Battiscopa	40 8,55 kg	20 8,55 kg	10 8,55 kg
	<b>290815</b> MONOLITH WHITE BATTISCOPIA 5x30 Cod. <b>116</b> △	<b>290820</b> MONOLITH WHITE BATTISCOPIA 5x60 Cod. <b>121</b> △	<b>290827</b> MONOLITH WHITE BATTISCOPIA 5x120 Cod. <b>33</b> △
	<b>290819</b> MONOLITH TAUPE BATTISCOPIA 5x30 Cod. <b>116</b> △	<b>290824</b> MONOLITH TAUPE BATTISCOPIA 5x60 Cod. <b>121</b> △	<b>290826</b> MONOLITH TAUPE BATTISCOPIA 5x120 Cod. <b>33</b> △
	<b>290818</b> MONOLITH GREY BATTISCOPIA 5x30 Cod. <b>116</b> △	<b>290823</b> MONOLITH GREY BATTISCOPIA 5x60 Cod. <b>121</b> △	<b>290830</b> MONOLITH GREY BATTISCOPIA 5x120 Cod. <b>33</b> △
	<b>290816</b> MONOLITH MUD BATTISCOPIA 5x30 Cod. <b>116</b> △	<b>290821</b> MONOLITH MUD BATTISCOPIA 5x60 Cod. <b>121</b> △	<b>290828</b> MONOLITH MUD BATTISCOPIA 5x120 Cod. <b>33</b> △
	<b>290817</b> MONOLITH BLACK BATTISCOPIA 5x30 Cod. <b>116</b> △	<b>290822</b> MONOLITH BLACK BATTISCOPIA 5x60 Cod. <b>121</b> △	<b>290829</b> MONOLITH BLACK BATTISCOPIA 5x120 Cod. <b>33</b> △
Gradino	2 8,00 kg	Angolare	2 10,00 kg
	<b>490787</b> MONOLITH WHITE GRADINO 33x60 Cod. <b>112</b> ○		<b>490792</b> MONOLITH WHITE ANGOLARE 33x60 Cod. <b>107</b> ○
	<b>490791</b> MONOLITH TAUPE GRADINO 33x60 Cod. <b>112</b> ○		<b>490796</b> MONOLITH TAUPE ANGOLARE 33x60 Cod. <b>107</b> ○
	<b>490790</b> MONOLITH GREY GRADINO 33x60 Cod. <b>112</b> ○		<b>490795</b> MONOLITH GREY ANGOLARE 33x60 Cod. <b>107</b> ○
	<b>490788</b> MONOLITH MUD GRADINO 33x60 Cod. <b>112</b> ○		<b>490793</b> MONOLITH MUD ANGOLARE 33x60 Cod. <b>107</b> ○
	<b>490789</b> MONOLITH BLACK GRADINO 33x60 Cod. <b>112</b> ○		<b>490794</b> MONOLITH BLACK ANGOLARE 33x60 Cod. <b>107</b> ○
	2 16,00 kg		2 20,00 kg
	<b>490797</b> MONOLITH WHITE GRADINO 33x120 Cod. <b>114</b> ○		<b>490802</b> MONOLITH WHITE ANGOLARE 33x120 Cod. <b>110</b> ○
	<b>490801</b> MONOLITH TAUPE GRADINO 33x120 Cod. <b>114</b> ○		<b>490806</b> MONOLITH TAUPE ANGOLARE 33x120 Cod. <b>110</b> ○
	<b>490800</b> MONOLITH GREY GRADINO 33x120 Cod. <b>114</b> ○		<b>490805</b> MONOLITH GREY ANGOLARE 33x120 Cod. <b>110</b> ○
	<b>490798</b> MONOLITH MUD GRADINO 33x120 Cod. <b>114</b> ○		<b>490803</b> MONOLITH MUD ANGOLARE 33x120 Cod. <b>110</b> ○
	<b>490799</b> MONOLITH BLACK GRADINO 33x120 Cod. <b>114</b> ○		<b>490804</b> MONOLITH BLACK ANGOLARE 33x120 Cod. <b>110</b> ○

CARATTERISTICHE DI QUALITÀ Quality characteristics Caractéristiques de qualité Qualitätseigenschaften	NORMA Norm Norme Norme	REQUISITO NORMA Required standards Valeur prescrite selon la norme Normvorgabe	RISULTATO Result Résultat Ergebniss
 Assorbimento d'acqua Water absorption of the body Absorption d'eau de support Wasseraufnahme des Scherbens	ISO 10545-3	≤ 0,5	Conforme Conformity Conforme Gemäss
 Resistenza a flessione Breaking strength Résistance à la flexion Biegefestigkeit	ISO 10545-4	≥ 35 N/mm <sup>2</sup>	Conforme Conformity Conforme Gemäss
 Resistenza all'abrasione Abrasion resistance Résistance à l'abrasion Abriebbeständigkeit	EN ISO 10545-7	Mud Black	PEI IV
		White Grey Taupe	PEI V
 Resistenza al gelo Frost resistance Résistance au gel Frostbeständigkeit	ISO 10545-12	Nessun campione deve presentare rotture o alterazioni apprezzabili alla superficie No samples must show ruptures or noticeable surface alteration Aucuns enchantions doit présenter ruptures ou altérations appréciables de la surface Keines der Muster sollte Risse oder sichtbare Fehler der Oberfläche zeigen	Conforme Conformity Conforme Gemäss
 Resistenza all'attacco chimico Chemical resistance Résistance à l'attaque chimique Beständigkeit gegen chemikalien	ISO 10545-13		GA GLA
 Resistenza agli sbalzi termici Thermal shock resistance Résistance aux écarts de température Temperaturwechselbeständigkeit	ISO 10545-5		Conforme Conformity Conforme Gemäss
 Resistenza scivolosità Sliding resistance Résistance au glissement Rutschfestigkeit	DIN 51130 R	Versioni 9 mm / 10 mm	R10
		Versione 20 mm	R11
 Resistenza scivolosità Sliding resistance Résistance au glissement Rutschfestigkeit	DIN 51097 (A+B+C)	Versioni 9 mm / 10 mm	A+B
		Versione 20 mm	A+B+C
 Coefficiente d'attrito dinamico Wet dynamic coefficient of friction Coefficient de friction dynamique Reibungskoeffizient Schlipfgrigkeit (in Bewegung)	Bot 3000 E	DCOF ≥ 0,42	> 0,42
 Significativa variazione Significant variation Variation important Bedeutsam Abweichung			V3

 V1 Aspetto uniforme Uniform appearance Aspect uniforme Einheitliches Aussehen	 V2 Lieve variazione Slight variation Légère variation Geringe Abweichung	 V3 Significativa variazione Significant variation Variation important Bedeutsam Abweichung	 V4 Forte stonalizzazione Substantial variation Effet dénuancé très accentué Akzentuierte Variation
---	--	--	--

**PER UNA POSA OTTIMALE DEL PRODOTTO CONSIGLIAMO SEMPRE DI MESCOLARE ALMENO TRE SCATOLE DI MATERIALE.**  
For the best product laying results, material from at least three boxes should be mixed.  
Pour une pose excellente, nous recommandons toujours de mélanger le contenu d'au moins trois boîtes.  
Für eine optimale Verlegung des Erzeugnisses empfehlen wir stets, mindestens drei Packungen Material anzumischen.



Tipologia  
Type  
Typologie  
Typ  
Gres porcellanato smaltato  
Glazed porcelain  
Grès cérame emaille  
Feinsteinzeug glasiert

Formati R10 A- B- C  
Sizes  
Formats  
Formate  
40x80  
20x80  
60x60  
30x60  
15x60  
30x30  
10x30  
15x15  
7,5x15

Spessore  
Thickness  
Épaisseur  
Stärke  
9 mm

Resistenza scivolosità  
Sliding resistance  
Resistance au glissement  
Rutschfestigkeit  
R10 / A+B+C

Grado di variazione cromatica  
Degree of colour change  
Degré de variation chromatique  
Grad der Farbabweichung  
V3



**606105**  
MOVE BLACK RETTIFICATO 60x60  
Cod. **79** □



**490321**  
MOVE BLACK RETTIFICATO 30x60  
Cod. **76** □



**550090**  
MOVE BLACK RETTIFICATO 15x60  
Cod. **95** □

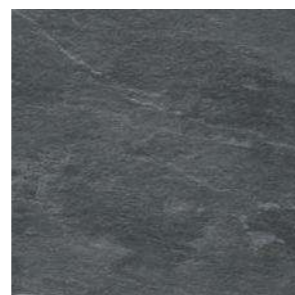

**040789**  
MOVE BLACK RETTIFICATO 30x30  
Cod. **78** □



**103037**  
MOVE BLACK RETTIFICATO 10x30  
Cod. **77** □



**040799**  
MOVE BLACK SFUSO 7,5x15  
Cod. **95** □

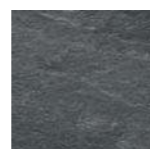

**230222**  
MOVE BLACK RETTIFICATO 15x15  
Cod. **78** □



**310183**  
MOVE BLACK LONDON 4x30  
Cod. **33** ○



2,80 kg



**408042**  
MOVE BLACK RETTIFICATO 40x80  
Cod. **79** □



**208033**  
MOVE BLACK RETTIFICATO 20x80  
Cod. **89** □

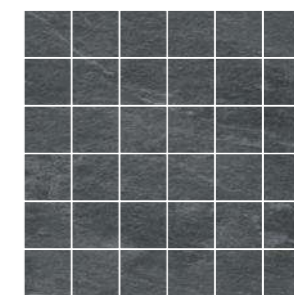

**040794**  
MOVE BLACK  
MOSAICO 5x5 SU RETE 30x30  
Cod. **24** ○



9,12 kg

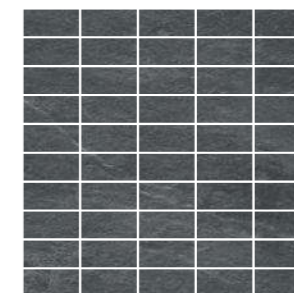

**501118**  
MOVE BLACK  
MOSAICO FRAME 2,8x5,8 SU RETE 30x30  
Cod. **28** ○



9,00 kg



**380153**  
MOVE BLACK BORDURA 5x30  
Cod. **21** ○



6,25 kg

SOLO RIVESTIMENTO  
Wall application only  
Pose mur seulement  
Ausschliesslich Wandbordüre



**123004**  
MOVE BLACK MOSAICO ONDA 12x30  
Cod. **28** ○



4,90 kg

IMBALLI • PACKAGES • EMBALLAGES • FORMATE

	SCATOLA • BOX • BOITE • KARTON			PALLET • PALLETS • PALETTS • PALETTE		
	pz	m <sup>q</sup>	kg	box	m <sup>q</sup>	kg
<b>40x80</b>	3	0,96	18,90	56	53,76	1.058,00
<b>20x80</b>	6	0,96	18,90	42	40,32	794,00
<b>60x60</b>	3	1,08	21,30	40	43,20	850,00
<b>30x60</b>	6	1,08	21,20	40	43,20	850,00
<b>30x30</b>	11	0,99	19,10	46	45,54	879,00
<b>10x30</b>	20	0,60	12,50	60	36,00	750,00
<b>7,5x15</b>	50	0,56	11,00	60	33,60	660,00
<b>15x15</b>	46	1,035	20,30	33	34,15	670,00
<b>15x60</b>	10	0,90	17,70	48	43,20	850,00



**606104**  
MOVE BEIGE RETTIFICATO 60x60  
Cod. **79** □



**490320**  
MOVE BEIGE RETTIFICATO 30x60  
Cod. **76** □



**550089**  
MOVE BEIGE RETTIFICATO 15x60  
Cod. **95** □



**040787**  
MOVE BEIGE RETTIFICATO 30x30  
Cod. **78** □



**103035**  
MOVE BEIGE RETTIFICATO 10x30  
Cod. **77** □



**040797**  
MOVE BEIGE SFUSO 7,5x15  
Cod. **95** □

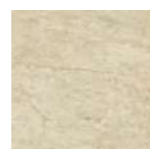

**230220**  
MOVE BEIGE RETTIFICATO 15x15  
Cod. **78** □



**24**  
2,80 kg

**310181**  
MOVE BEIGE LONDON 4x30  
Cod. **33** ○



**408040**  
MOVE BEIGE RETTIFICATO 40x80  
Cod. **79** □



**208031**  
MOVE BEIGE RETTIFICATO 20x80  
Cod. **89** □



**6**  
9,12 kg

**040792**  
MOVE BEIGE  
MOSAICO 5x5 SU RETE 30x30  
Cod. **24** ○

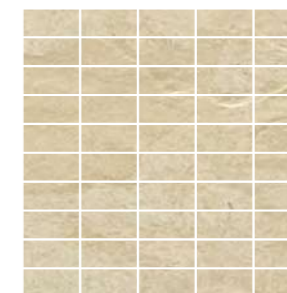

**6**  
9,00 kg

**501116**  
MOVE BEIGE  
MOSAICO FRAME 2,8x5,8 SU RETE 30x30  
Cod. **28** ○



**25**  
6,25 kg

**380151**  
MOVE BEIGE BORDURA 5x30  
Cod. **21** ○

SOLO RIVESTIMENTO  
Wall application only  
Pose mur seulement  
Ausschliesslich Wandbordüre



**8**  
4,90 kg

**123002**  
MOVE BEIGE MOSAICO ONDA 12x30  
Cod. **28** ○

IMBALLI • PACKAGES • EMBALLAGES • FORMATE

	SCATOLA • BOX • BOITE • KARTON			PALLET • PALLETS • PALETTS • PALETTE		
	pz	m <sup>q</sup>	kg	box	m <sup>q</sup>	kg
<b>40x80</b>	3	0,96	18,90	56	53,76	1.058,00
<b>20x80</b>	6	0,96	18,90	42	40,32	794,00
<b>60x60</b>	3	1,08	21,30	40	43,20	850,00
<b>30x60</b>	6	1,08	21,20	40	43,20	850,00
<b>30x30</b>	11	0,99	19,10	46	45,54	879,00
<b>10x30</b>	20	0,60	12,50	60	36,00	750,00
<b>7,5x15</b>	50	0,56	11,00	60	33,60	660,00
<b>15x15</b>	46	1,035	20,30	33	34,15	670,00
<b>15x60</b>	10	0,90	17,70	48	43,20	850,00



**606106**  
MOVE GREY RETTIFICATO 60x60  
Cod. **79** □



**490322**  
MOVE GREY RETTIFICATO 30x60  
Cod. **76** □



**550091**  
MOVE GREY RETTIFICATO 15x60  
Cod. **95** □



**040788**  
MOVE GREY RETTIFICATO 30x30  
Cod. **78** □



**103036**  
MOVE GREY RETTIFICATO 10x30  
Cod. **77** □



**040798**  
MOVE GREY SFUSO 7,5x15  
Cod. **95** □



**230221**  
MOVE GREY RETTIFICATO 15x15  
Cod. **78** □



**310182**  
MOVE GREY LONDON 4x30  
Cod. **33** ○



2,80 kg



**408041**  
MOVE GREY RETTIFICATO 40x80  
Cod. **79** □



**208032**  
MOVE GREY RETTIFICATO 20x80  
Cod. **89** □



**040793**  
MOVE GREY  
MOSAICO 5x5 SU RETE 30x30  
Cod. **24** ○



9,12 kg

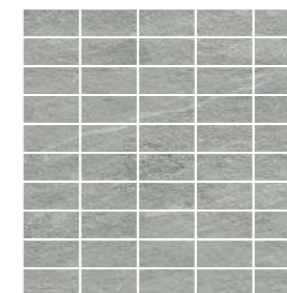

**501117**  
MOVE GREY  
MOSAICO FRAME 2,8x5,8 SU RETE 30x30  
Cod. **28** ○



9,00 kg



**380152**  
MOVE GREY BORDURA 5x30  
Cod. **21** ○



6,25 kg

SOLO RIVESTIMENTO  
Wall application only  
Pose mur seulement  
Ausschliesslich Wandbordure



**123003**  
MOVE GREY MOSAICO ONDA 12x30  
Cod. **28** ○



4,90 kg

IMBALLI • PACKAGES • EMBALLAGES • FORMATE

	SCATOLA • BOX • BOITE • KARTON			PALLET • PALLETS • PALETTS • PALETTE		
	pz	m <sup>q</sup>	kg	box	m <sup>q</sup>	kg
<b>40x80</b>	3	0,96	18,90	56	53,76	1.058,00
<b>20x80</b>	6	0,96	18,90	42	40,32	794,00
<b>60x60</b>	3	1,08	21,30	40	43,20	850,00
<b>30x60</b>	6	1,08	21,20	40	43,20	850,00
<b>30x30</b>	11	0,99	19,10	46	45,54	879,00
<b>10x30</b>	20	0,60	12,50	60	36,00	750,00
<b>7,5x15</b>	50	0,56	11,00	60	33,60	660,00
<b>15x15</b>	46	1,035	20,30	33	34,15	670,00
<b>15x60</b>	10	0,90	17,70	48	43,20	850,00



**606107**  
MOVE IVORY RETTIFICATO 60x60  
Cod. **79** □



**490323**  
MOVE IVORY RETTIFICATO 30x60  
Cod. **76** □

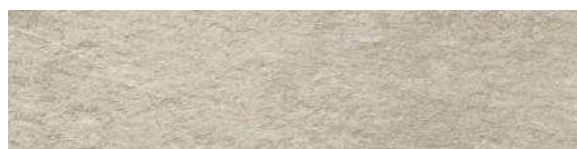

**550092**  
MOVE IVORY RETTIFICATO 15x60  
Cod. **95** □



**040786**  
MOVE IVORY RETTIFICATO 30x30  
Cod. **78** □



**103034**  
MOVE IVORY RETTIFICATO 10x30  
Cod. **77** □



**040796**  
MOVE IVORY SFUSO 7,5x15  
Cod. **95** □

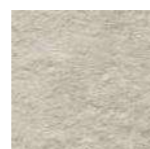

**230219**  
MOVE IVORY RETTIFICATO 15x15  
Cod. **78** □



**310180**  
MOVE IVORY LONDON 4x30  
Cod. **33** ○



2,80 kg



**408039**  
MOVE IVORY RETTIFICATO 40x80  
Cod. **79** □



**208030**  
MOVE IVORY RETTIFICATO 20x80  
Cod. **89** □



**040791**  
MOVE IVORY  
MOSAICO 5x5 SU RETE 30x30  
Cod. **24** ○



9,12 kg



**501115**  
MOVE IVORY  
MOSAICO FRAME 2,8x5,8 SU RETE 30x30  
Cod. **28** ○



9,00 kg



**380150**  
MOVE IVORY BORDURA 5x30  
Cod. **21** ○



6,25 kg

SOLO RIVESTIMENTO  
Wall application only  
Pose mur seulement  
Ausschliesslich Wandbordüre



**123001**  
MOVE IVORY MOSAICO ONDA 12x30  
Cod. **28** ○



4,90 kg

IMBALLI • PACKAGES • EMBALLAGES • FORMATE

	SCATOLA • BOX • BOITE • KARTON			PALLET • PALLETS • PALETTS • PALETTE		
	pz	mq	kg	box	mq	kg
40x80	3	0,96	18,90	56	53,76	1.058,00
20x80	6	0,96	18,90	42	40,32	794,00
60x60	3	1,08	21,30	40	43,20	850,00
30x60	6	1,08	21,20	40	43,20	850,00
30x30	11	0,99	19,10	46	45,54	879,00
10x30	20	0,60	12,50	60	36,00	750,00
7,5x15	50	0,56	11,00	60	33,60	660,00
15x15	46	1,035	20,30	33	34,15	670,00
15x60	10	0,90	17,70	48	43,20	850,00



**606108**  
MOVE MUD RETTIFICATO 60x60  
Cod. **79** □



**490324**  
MOVE MUD RETTIFICATO 30x60  
Cod. **76** □



**550093**  
MOVE MUD RETTIFICATO 15x60  
Cod. **95** □



**040790**  
MOVE MUD RETTIFICATO 30x30  
Cod. **78** □



**103038**  
MOVE MUD RETTIFICATO 10x30  
Cod. **77** □



**040800**  
MOVE MUD SFUSO 7,5x15  
Cod. **95** □



**230223**  
MOVE MUD RETTIFICATO 15x15  
Cod. **78** □



**24**  
2,80 kg

**310184**  
MOVE MUD LONDON 4x30  
Cod. **33** ○



**408043**  
MOVE MUD RETTIFICATO 40x80  
Cod. **79** □



**208034**  
MOVE MUD RETTIFICATO 20x80  
Cod. **89** □

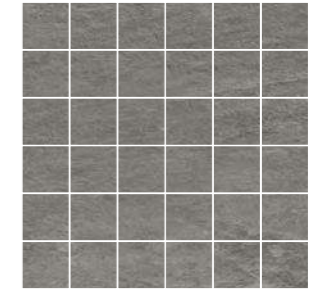

**6**  
9,12 kg

**040795**  
MOVE MUD  
MOSAICO 5x5 SU RETE 30x30  
Cod. **24** ○

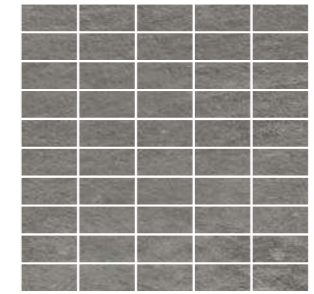

**6**  
9,00 kg

**501119**  
MOVE MUD  
MOSAICO FRAME 2,8x5,8 SU RETE 30x30  
Cod. **28** ○



**25**  
6,25 kg

**380154**  
MOVE MUD BORDURA 5x30  
Cod. **21** ○

SOLO RIVESTIMENTO  
Wall application only  
Pose mur seulement  
Ausschliesslich Wandbordure

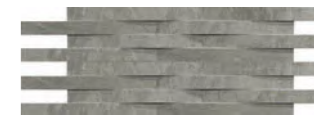



**8**  
4,90 kg



**123005**  
MOVE MUD MOSAICO ONDA 12x30  
Cod. **28** ○



IMBALLI • PACKAGES • EMBALLAGES • FORMATE

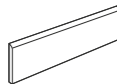



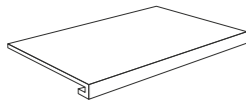
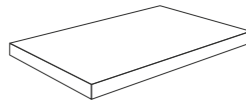



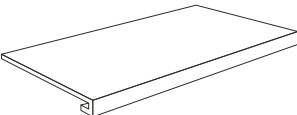
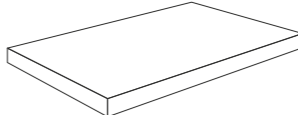

	SCATOLA • BOX • BOITE • KARTON			PALLET • PALLETS • PALETTS • PALETTE		
	pz	m <sup>q</sup>	kg	box	m <sup>q</sup>	kg
<b>40x80</b>	3	0,96	18,90	56	53,76	1.058,00
<b>20x80</b>	6	0,96	18,90	42	40,32	794,00
<b>60x60</b>	3	1,08	21,30	40	43,20	850,00
<b>30x60</b>	6	1,08	21,20	40	43,20	850,00
<b>30x30</b>	11	0,99	19,10	46	45,54	879,00
<b>10x30</b>	20	0,60	12,50	60	36,00	750,00
<b>7,5x15</b>	50	0,56	11,00	60	33,60	660,00
<b>15x15</b>	46	1,035	20,30	33	34,15	670,00
<b>15x60</b>	10	0,90	17,70	48	43,20	850,00

Pezzi speciali • Special trims • Pièces spéciales • Formstücke

Battiscopa	 22,40 kg	 17,10 kg
	<b>290527</b> MOVE IVORY BATTISCOPA 7x30 Cod. <b>116</b> △	<b>290532</b> MOVE IVORY BATTISCOPA 7x60 Cod. <b>121</b> △
	<b>290528</b> MOVE BEIGE BATTISCOPA 7x30 Cod. <b>116</b> △	<b>290533</b> MOVE BEIGE BATTISCOPA 7x60 Cod. <b>121</b> △
	<b>290529</b> MOVE GREY BATTISCOPA 7x30 Cod. <b>116</b> △	<b>290534</b> MOVE GREY BATTISCOPA 7x60 Cod. <b>121</b> △
	<b>290530</b> MOVE BLACK BATTISCOPA 7x30 Cod. <b>116</b> △	<b>290535</b> MOVE BLACK BATTISCOPA 7x60 Cod. <b>121</b> △
	<b>290531</b> MOVE MUD BATTISCOPA 7x30 Cod. <b>116</b> △	<b>290536</b> MOVE MUD BATTISCOPA 7x60 Cod. <b>121</b> △

Gradino	 8,00 kg	Angolare	 10,00 kg
	<b>490349</b> MOVE IVORY RETTIFICATO GRADINO 33x60 Cod. <b>112</b> ○		<b>490354</b> MOVE IVORY RETTIFICATO ANGOLARE 33x60 Cod. <b>107</b> ○
	<b>490346</b> MOVE BEIGE RETTIFICATO GRADINO 33x60 Cod. <b>112</b> ○		<b>490351</b> MOVE BEIGE RETTIFICATO ANGOLARE 33x60 Cod. <b>107</b> ○
	<b>490348</b> MOVE GREY RETTIFICATO GRADINO 33x60 Cod. <b>112</b> ○		<b>490353</b> MOVE GREY RETTIFICATO ANGOLARE 33x60 Cod. <b>107</b> ○
	<b>490347</b> MOVE BLACK RETTIFICATO GRADINO 33x60 Cod. <b>112</b> ○		<b>490352</b> MOVE BLACK RETTIFICATO ANGOLARE 33x60 Cod. <b>107</b> ○
	<b>490350</b> MOVE MUD RETTIFICATO GRADINO 33x60 Cod. <b>112</b> ○		<b>490355</b> MOVE MUD RETTIFICATO ANGOLARE 33x60 Cod. <b>107</b> ○

Gradino	 14,50 kg	Angolare	 17,00 kg
	<b>408044</b> MOVE IVORY RETTIFICATO GRADINO 40x80 Cod. <b>109</b> ○		<b>408049</b> MOVE IVORY RETTIFICATO ANGOLARE 40x80 Cod. <b>114</b> ○
	<b>408045</b> MOVE BEIGE RETTIFICATO GRADINO 40x80 Cod. <b>109</b> ○		<b>408050</b> MOVE BEIGE RETTIFICATO ANGOLARE 40x80 Cod. <b>114</b> ○
	<b>408046</b> MOVE GREY RETTIFICATO GRADINO 40x80 Cod. <b>109</b> ○		<b>408051</b> MOVE GREY RETTIFICATO ANGOLARE 40x80 Cod. <b>114</b> ○
	<b>408047</b> MOVE BLACK RETTIFICATO GRADINO 40x80 Cod. <b>109</b> ○		<b>408052</b> MOVE BLACK RETTIFICATO ANGOLARE 40x80 Cod. <b>114</b> ○
	<b>408048</b> MOVE MUD RETTIFICATO GRADINO 40x80 Cod. <b>109</b> ○		<b>408053</b> MOVE MUD RETTIFICATO ANGOLARE 40x80 Cod. <b>114</b> ○

CARATTERISTICHE DI QUALITÀ Quality characteristics Caractéristiques de qualité Qualitätseigenschaften	NORMA Norm Norme Norme	REQUISITO NORMA Required standards Valeur prescrite selon la norme Normvorgabe	RISULTATO Result Résultat Ergebniss
 Assorbimento d'acqua Water absorption of the body Absorption d'eau de support Wasseraufnahme des Scherbens	ISO 10545-3	≤ 0,5	Conforme Conformity Conforme Gemäss
 Resistenza a flessione Breaking strenght Résistance à la flexion Biegefestigkeit	ISO 10545-4	≥ 35 N/mm <sup>2</sup>	Conforme Conformity Conforme Gemäss
 Resistenza all'abrasione Abrasion resistance Resistance a l'abrasion Abriebbeständigkeit	EN ISO 10545-7	IVORY - BEIGE - GREY	PEI V
		MUD - BLACK	PEI IV
 Resistenza al gelo Frost resistance Résistance au gel Frostbeständigkeit	ISO 10545-12	Nessun campione deve presentare rotture o alterazioni apprezzabili alla superficie No samples must show ruptures or noticeable surface alteration Aucuns enchantions doit présenter ruptures ou altérations appréciables de la surface Keines der Muster sollte Risse oder sichtbare Fehler der Oberfläche zeigen	Conforme Conformity Conforme Gemäss
 Resistenza all'attacco chimico Chemical resistance Résistance à l'attaque chimique Beständigkeit gegen chemikalien	ISO 10545-13		GA GLA
 Resistenza agli sbalzi termici Thermal shock resistance Resistance aux ecarts de température Temperaturwechselbeständigkeit	ISO 10545-5		Conforme Conformity Conforme Gemäss
 Resistenza scivolosità Sliding resistance Resistance au glissement Rutschfestigkeit	DIN 51130 R	Move Rettificato e Naturale	R10
 Resistenza scivolosità Sliding resistance Resistance au glissement Rutschfestigkeit	DIN 51097 (A+B+C)		A+B
 Coefficiente d'attrito dinamico Wet dynamic coefficient of friction Coefficient de friction dynamique Reibungskoeffizient Schlüpfriegerkeit (in Bewegung)	Bot 3000 E	DCOF ≥ 0,42	> 0,42
 Significativa variazione Significant variation Variation important Bedeutung Abweichung			V3

 **V1**  
Aspetto uniforme  
Uniform appearance  
Aspect uniforme  
Einheitliches Aussehen

 **V2**  
Lieve variazione  
Slight variation  
Légère variation  
Geringe Abweichung

 **V3**  
Significativa variazione  
Significant variation  
Variation important  
Bedeutung Abweichung

 **V4**  
Forte stonalizzazione  
Substantial variation  
Effet dénuancé très accentué  
Akzentuierte Variation

**PER UNA POSA OTTIMALE DEL PRODOTTO CONSIGLIAMO SEMPRE DI MESCOLARE ALMENO TRE SCATOLE DI MATERIALE.**

For the best product laying results, material from at least three boxes should be mixed.

Pour une pose excellente, nous recommandons toujours de mélanger le contenu d'au moins trois boîtes.

Für eine optimale Verlegung des Erzeugnisses empfehlen wir stets, mindestens drei Packungen Material anzumischen.





Tipologia  
Type  
Typologie  
Typ  
Gres porcellanato smaltato  
Glazed porcelain  
Grès cérame emaille  
Feinsteinzeug glasiert

Formati  
Sizes  
Formats  
Formate  
6x25

Spessore  
Thickness  
Épaisseur  
Stärke  
10 mm

Resistenza scivolosità  
Sliding resistance  
Resistance au glissement  
Rutschfestigkeit  
R10 (Matt)

Grado di variazione cromatica  
Degree of colour change  
Degré de variation chromatique  
Grad der Farbabweichung  
V2 - V3



**296015**  
MY ART BIANCO GLOSSY  
6x25  
Cod. 90 □



**420421**  
MY ART BIANCO GLOSSY  
Q-ROUND 1x25  
Cod. 15 ○



0,20 kg

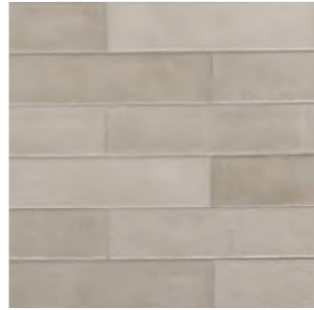

**296019**  
MY ART TORTORA GLOSSY  
6x25  
Cod. 90 □



**420425**  
MY ART TORTORA GLOSSY  
Q-ROUND 1x25  
Cod. 15 ○



0,20 kg



**296014**  
MY ART BIANCO MATT  
6x25  
Cod. 90 □



**420420**  
MY ART BIANCO MATT  
Q-ROUND 1x25  
Cod. 15 ○



0,20 kg

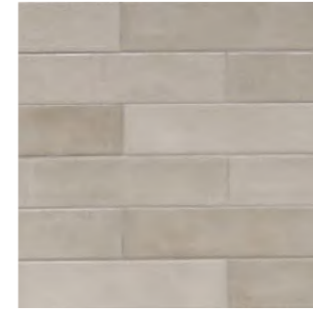

**296018**  
MY ART TORTORA MATT  
6x25  
Cod. 90 □



**420424**  
MY ART TORTORA MATT  
Q-ROUND 1x25  
Cod. 15 ○



0,20 kg



**296017**  
MY ART FANGO GLOSSY  
6x25  
Cod. 90 □



**420423**  
MY ART FANGO GLOSSY  
Q-ROUND 1x25  
Cod. 15 ○



0,20 kg



**296013**  
MY ART NERO GLOSSY  
6x25  
Cod. 90 □



**420419**  
MY ART NERO GLOSSY  
Q-ROUND 1x25  
Cod. 15 ○



0,20 kg



**296016**  
MY ART FANGO MATT  
6x25  
Cod. 90 □



**420422**  
MY ART FANGO MATT  
Q-ROUND 1x25  
Cod. 15 ○



0,20 kg

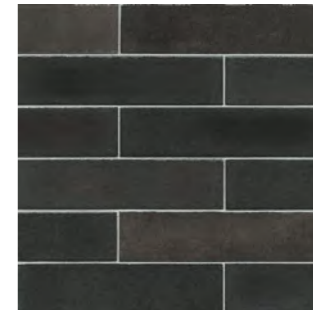

**296012**  
MY ART NERO MATT  
6x25  
Cod. 90 □



**420418**  
MY ART NERO MATT  
Q-ROUND 1x25  
Cod. 15 ○



0,20 kg

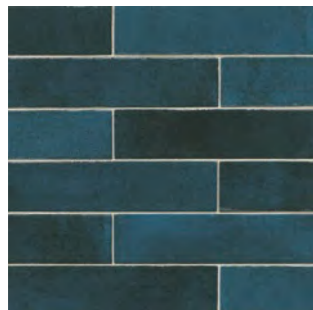

**296021**  
MY ART BLU GLOSSY  
6x25  
Cod. 90 □



**420427**  
MY ART BLU GLOSSY  
Q-ROUND 1x25  
Cod. 15 ○



0,20 kg

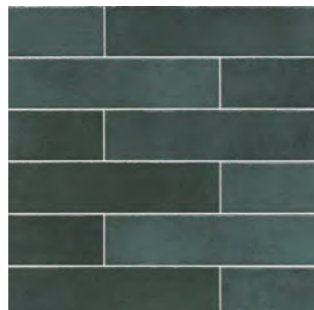

**296020**  
MY ART VERDE GLOSSY  
6x25  
Cod. 90 □



**420426**  
MY ART VERDE GLOSSY  
Q-ROUND 1x25  
Cod. 15 ○



0,20 kg

IMBALLI • PACKAGES • EMBALLAGES • FORMATE

6x25	SCATOLA • BOX • BOITE • KARTON			PALLET • PALLETS • PALETTS • PALETTE		
	pz	mq	kg	box	mq	kg
	32	0,48	9,60	100	48,00	960,00



CARATTERISTICHE DI QUALITÀ Quality characteristics Caractéristiques de qualité Qualitätseigenschaften	NORMA Norm Norme Norme	REQUISITO NORMA Required standards Valeur prescrite selon la norme Normvorgabe	RISULTATO Result Résultat Ergebniss
Assorbimento d'acqua Water absorption of the body Absorption d'eau de support Wasseraufnahme des Scherbens	ISO 10545-3	≤ 0,5	Conforme Conformity Conforme Gemäss
Resistenza a flessione Breaking strenght Résistance à la flexion Biegefestigkeit	ISO 10545-4	≥ 35 N/mm <sup>2</sup>	Conforme Conformity Conforme Gemäss
Resistenza all'abrasione Abrasion resistance Resistance a l'abrasion Abriebbeständigkeit	ISO 10545-7	MATT: Bianco - Fango - Tortora - Nero	PEI IV
		GLOSSY: Nero - Blu - Verde GLOSSY: Bianco - Fango - Tortora	PEI II PEI III
Resistenza al gelo Frost resistance Résistance au gel Frostbeständigkeit	ISO 10545-12	Nessun campione deve presentare rotture o alterazioni apprezzabili alla superficie No samples must show ruptures or noticeable surface alteration Aucuns enchantions doit présenter ruptures ou altérations appréciables de la surface Keines der Muster sollte Risse oder sichtbare Fehler der Oberfläche zeigen	Conforme Conformity Conforme Gemäss
Resistenza all'attacco chimico Chemical resistance Résistance à l'attaque chimique Beständigkeit gegen chemikalien	ISO 10545-13		GA GLA
Resistenza agli sbalzi termici Thermal shock resistance Resistance aux ecart de température Temperaturwechselbeständigkeit	ISO 10545-5		Conforme Conformity Conforme Gemäss
Resistenza scivolosità Sliding resistance Resistance au glissement Rutschfestigkeit	DIN 51130 R		R10 Matt
Coefficiente d'attrito dinamico Wet dynamic coefficient of friction Coefficient de friction dynamique Reibungskoeffizient Schlüpfrigkeit (in Bewegung)	Bot 3000 E	DCOF ≥ 0,42	> 0,42 Matt
Lieve variazione Slight variation Légère variation Geringe Abweichung		Bianco - Nero - Tortora	V2
Significativa variazione Significant variation Variation important Bedeutsam Abweichung		Blu - Verde - Fango	V3

V1 Aspetto uniforme Uniform appearance Aspect uniforme Einheitliches Aussehen	V2 Lieve variazione Slight variation Légère variation Geringe Abweichung	V3 Significativa variazione Significant variation Variation important Bedeutsam Abweichung	V4 Forte stonizzazione Substantial variation Effet dénuancé très accentué Akzentuierte Variation
---	--	--	--

**PER UNA POSA OTTIMALE DEL PRODOTTO CONSIGLIAMO SEMPRE DI MESCOLARE ALMENO TRE SCATOLE DI MATERIALE.**  
For the best product laying results, material from at least three boxes should be mixed.  
Pour une pose excellente, nous recommandons toujours de mélanger le contenu d'au moins trois boîtes.  
Für eine optimale Verlegung des Erzeugnisses empfehlen wir stets, mindestens drei Packungen Material anzumischen.



Tipologia  
Type  
Typologie  
Typ  
Gres porcellanato smaltato  
Glazed porcelain  
Grès cérame emaille  
Feinsteinzeug glasiert

Formati R10  
Sizes  
Formats  
Formate  
60x120  
90x90  
60x60  
30x60  
20x120  
10x30

Formati R11 A - B - C  
Sizes  
Formats  
Formate  
30x60

Spessore  
Thickness  
Épaisseur  
Stärke  
9 mm  
20 mm

Resistenza scivolosità  
Sliding resistance  
Resistance au glissement  
Rutschfestigkeit  
R10 / A+B  
R11 / A+B+C

Grado di variazione cromatica  
Degree of colour change  
Degré de variation chromatique  
Grad der Farbabweichung  
V3



601354  
NEXXT TAUPE  
RETTIFICATO 60x120  
Cod. 94 □



601371  
NEXXT TAUPE STRUTTURA  
RETTIFICATO 60x120  
Cod. 111 □

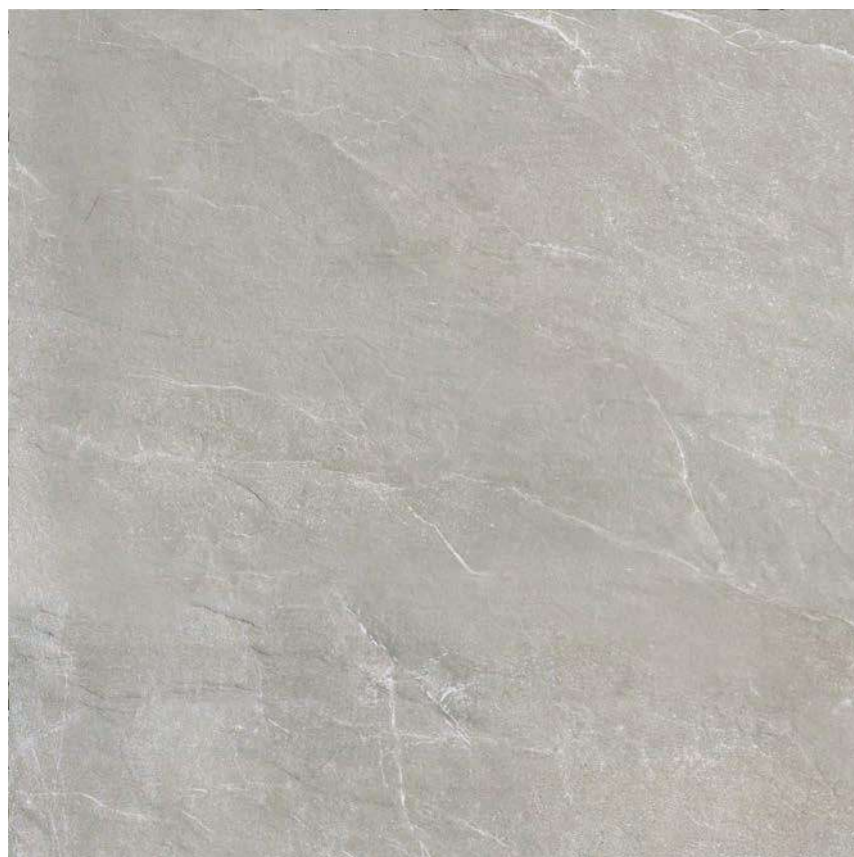

**909080**  
NEXXT TAUPE  
RETTIFICATO 90x90  
Cod. **97** □



**606309**  
NEXXT TAUPE  
RETTIFICATO 60x60  
Cod. **79** □



**490894**  
NEXXT TAUPE  
RETTIFICATO 30x60  
Cod. **76** □

**490907**  
NEXXT TAUPE  
RETTIFICATO R11 30x60  
Cod. **77** □



**103182**  
NEXXT TAUPE  
RETTIFICATO 10x30  
Cod. **77** □



**201243**  
NEXXT TAUPE  
RETTIFICATO 20x120  
Cod. **111** □



**041606**  
NEXXT TAUPE  
MOSAICO 5x5 SU RETE 30x30  
Cod. **24** ○



9,12 kg



**380328**  
NEXXT TAUPE  
MOSAICO 3D MULTILEVEL SU RETE 31x30  
Cod. **51** ○



6,50 kg



**041614**  
NEXXT TAUPE  
MOSAICO CHEVRON SU RETE 33,7x26  
Cod. **69** ○



7,50 kg



**041610**  
NEXXT TAUPE  
MOSAICO ESAGONO SU RETE 30x26  
Cod. **128** ○



6,00 kg

IMBALLI • PACKAGES • EMBALLAGES • FORMATE

	SCATOLA • BOX • BOITE • KARTON			PALLET • PALLETS • PALETTS • PALETTE		
	pz	mq	kg	box	mq	kg
<b>90x90</b>	2	1,62	33,50	20	32,40	670,00
<b>60x120</b>	2	1,44	28,70	30	43,20	861,00
<b>60x120 Struttura</b>	2	1,44	28,70	30	43,20	861,00
<b>20x120</b>	4	0,96	19,20	30	28,80	576,00
<b>60x60</b>	3	1,08	21,30	40	43,20	850,00
<b>30x60</b>	6	1,08	21,20	40	43,20	850,00
<b>30x60 R11</b>	6	1,08	21,20	40	43,20	850,00
<b>10x30</b>	20	0,60	12,50	60	36,00	750,00



**601353**  
NEXXT IVORY  
RETTIFICATO 60x120  
Cod. **94** □



**601370**  
NEXXT IVORY STRUTTURA  
RETTIFICATO 60x120  
Cod. **111** □



**909079**  
NEXXT IVORY  
RETTIFICATO 90x90  
Cod. **97** □



**606308**  
NEXXT IVORY  
RETTIFICATO 60x60  
Cod. **79** □



**490893**  
NEXXT IVORY  
RETTIFICATO 30x60  
Cod. **76** □

**490906**  
NEXXT IVORY  
RETTIFICATO R11 30x60  
Cod. **77** □



**103181**  
NEXXT IVORY  
RETTIFICATO 10x30  
Cod. **77** □

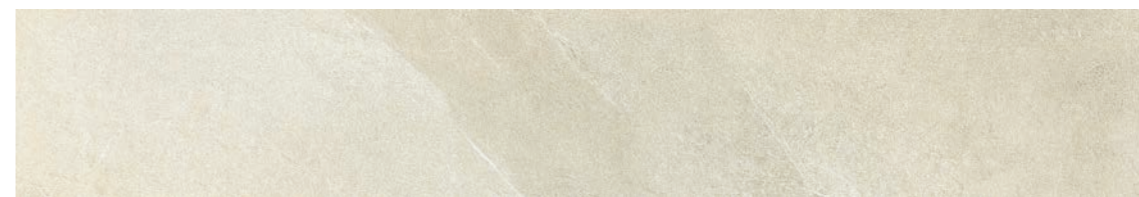

**201242**  
NEXXT IVORY  
RETTIFICATO 20x120  
Cod. **111** □



**041607**  
NEXXT IVORY  
MOSAICO 5x5 SU RETE 30x30  
Cod. **24** ○



9,12 kg



**380327**  
NEXXT IVORY  
MOSAICO 3D MULTILEVEL SU RETE 31x30  
Cod. **51** ○



6,50 kg



**041615**  
NEXXT IVORY  
MOSAICO CHEVRON SU RETE 33,7x26  
Cod. **69** ○



7,50 kg



**041611**  
NEXXT IVORY  
MOSAICO ESAGONO SU RETE 30x26  
Cod. **128** ○



6,00 kg

IMBALLI • PACKAGES • EMBALLAGES • FORMATE

	SCATOLA • BOX • BOITE • KARTON			PALLET • PALLETS • PALETTS • PALETTE		
	pz	mq	kg	box	mq	kg
<b>90x90</b>	2	1,62	33,50	20	32,40	670,00
<b>60x120</b>	2	1,44	28,70	30	43,20	861,00
<b>60x120 Struttura</b>	2	1,44	28,70	30	43,20	861,00
<b>20x120</b>	4	0,96	19,20	30	28,80	576,00
<b>60x60</b>	3	1,08	21,30	40	43,20	850,00
<b>30x60</b>	6	1,08	21,20	40	43,20	850,00
<b>30x60 R11</b>	6	1,08	21,20	40	43,20	850,00
<b>10x30</b>	20	0,60	12,50	60	36,00	750,00



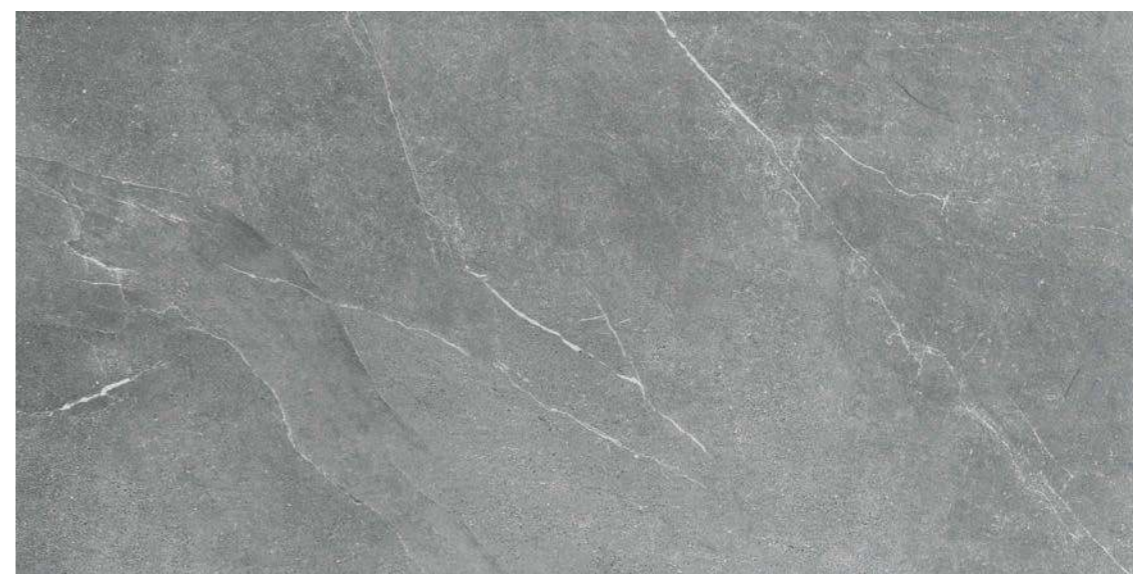

**601356**  
NEXXT MUD  
RETTIFICATO 60x120  
Cod. **94** □

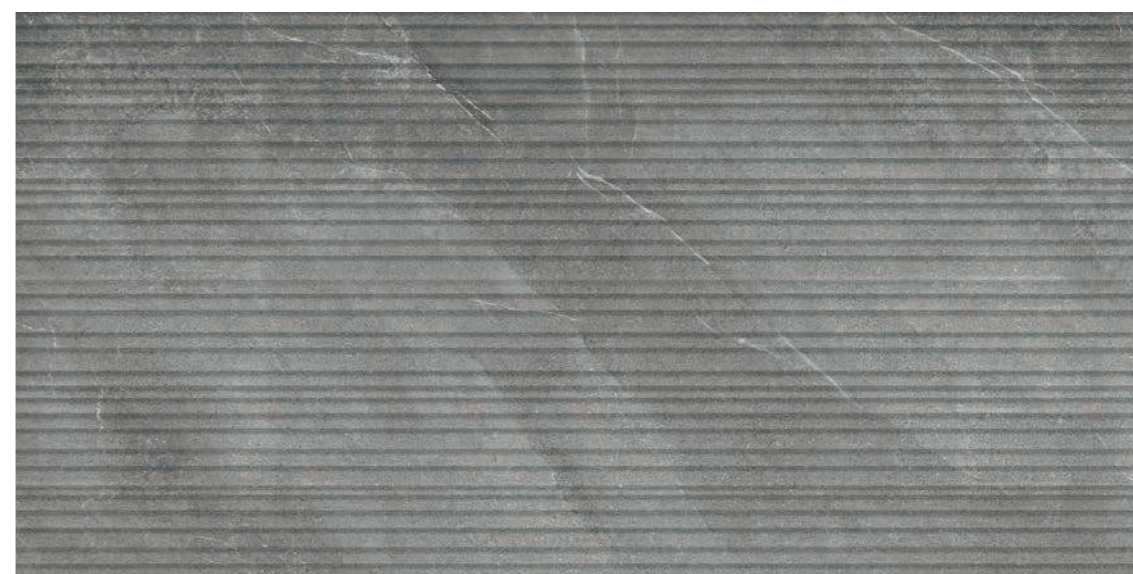

**601373**  
NEXXT MUD STRUTTURA  
RETTIFICATO 60x120  
Cod. **111** □



**909082**  
NEXXT MUD  
RETTIFICATO 90x90  
Cod. **97** □

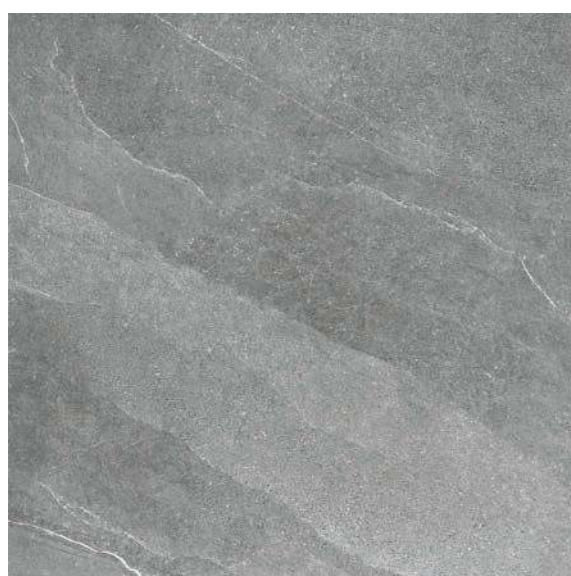

**606311**  
NEXXT MUD  
RETTIFICATO 60x60  
Cod. **79** □



**490896**  
NEXXT MUD  
RETTIFICATO 30x60  
Cod. **76** □

**490909**  
NEXXT MUD  
RETTIFICATO R11 30x60  
Cod. **77** □



**103184**  
NEXXT MUD  
RETTIFICATO 10x30  
Cod. **77** □



**201245**  
NEXXT MUD  
RETTIFICATO 20x120  
Cod. **111** □

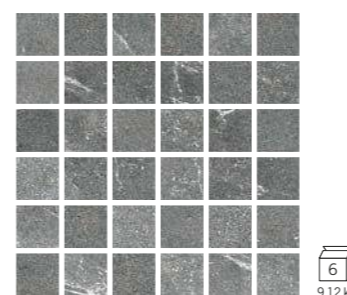

**041608**  
NEXXT MUD  
MOSAICO 5x5 SU RETE 30x30  
Cod. **24** ○



9,12 kg



**380330**  
NEXXT MUD  
MOSAICO 3D MULTILEVEL SU RETE 31x30  
Cod. **51** ○



6,50 kg

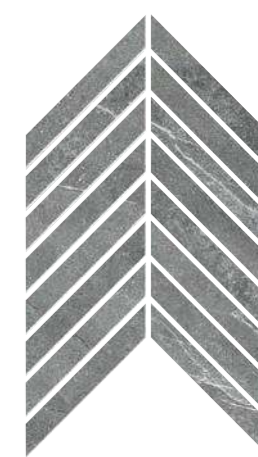

**041616**  
NEXXT MUD  
MOSAICO CHEVRON SU RETE 33,7x26  
Cod. **69** ○



7,50 kg



**041612**  
NEXXT MUD  
MOSAICO ESAGONO SU RETE 30x26  
Cod. **128** ○



6,00 kg

IMBALLI • PACKAGES • EMBALLAGES • FORMATE

	SCATOLA • BOX • BOITE • KARTON			PALLET • PALLETS • PALETTS • PALETTE		
	pz	mq	kg	box	mq	kg
<b>90x90</b>	2	1,62	33,50	20	32,40	670,00
<b>60x120</b>	2	1,44	28,70	30	43,20	861,00
<b>60x120 Struttura</b>	2	1,44	28,70	30	43,20	861,00
<b>20x120</b>	4	0,96	19,20	30	28,80	576,00
<b>60x60</b>	3	1,08	21,30	40	43,20	850,00
<b>30x60</b>	6	1,08	21,20	40	43,20	850,00
<b>30x60 R11</b>	6	1,08	21,20	40	43,20	850,00
<b>10x30</b>	20	0,60	12,50	60	36,00	750,00



601355  
NEXXT GREY  
RETTIFICATO 60x120  
Cod. 94 □



601372  
NEXXT GREY STRUTTURA  
RETTIFICATO 60x120  
Cod. 111 □



**909081**  
NEXXT GREY  
RETTIFICATO 90x90  
Cod. **97** □



**606310**  
NEXXT GREY  
RETTIFICATO 60x60  
Cod. **79** □



**490895**  
NEXXT GREY  
RETTIFICATO 30x60  
Cod. **76** □

**490908**  
NEXXT GREY  
RETTIFICATO R11 30x60  
Cod. **77** □



**103183**  
NEXXT GREY  
RETTIFICATO 10x30  
Cod. **77** □



**201244**  
NEXXT GREY  
RETTIFICATO 20x120  
Cod. **111** □



**041609**  
NEXXT GREY  
MOSAICO 5x5 SU RETE 30x30  
Cod. **24** ○



9,12 kg



**380329**  
NEXXT GREY  
MOSAICO 3D MULTILEVEL SU RETE 31x30  
Cod. **51** ○



6,50 kg



**041617**  
NEXXT GREY  
MOSAICO CHEVRON SU RETE 33,7x26  
Cod. **69** ○



7,50 kg

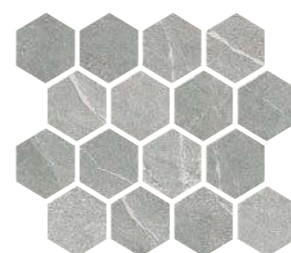

**041613**  
NEXXT GREY  
MOSAICO ESAGONO SU RETE 30x26  
Cod. **128** ○



6,00 kg

IMBALLI • PACKAGES • EMBALLAGES • FORMATE

	SCATOLA • BOX • BOITE • KARTON			PALLET • PALLETS • PALETTS • PALETTE		
	pz	mq	kg	box	mq	kg
<b>90x90</b>	2	1,62	33,50	20	32,40	670,00
<b>60x120</b>	2	1,44	28,70	30	43,20	861,00
<b>60x120 Struttura</b>	2	1,44	28,70	30	43,20	861,00
<b>20x120</b>	4	0,96	19,20	30	28,80	576,00
<b>60x60</b>	3	1,08	21,30	40	43,20	850,00
<b>30x60</b>	6	1,08	21,20	40	43,20	850,00
<b>30x60 R11</b>	6	1,08	21,20	40	43,20	850,00
<b>10x30</b>	20	0,60	12,50	60	36,00	750,00



601367  
NEXXT TAUPE 2 CM RETTIFICATO 60x120  
Cod. 141 □

± 20 mm



601369  
NEXXT MUD 2 CM RETTIFICATO 60x120  
Cod. 141 □

± 20 mm



601366  
NEXXT IVORY 2 CM RETTIFICATO 60x120  
Cod. 141 □

± 20 mm



601368  
NEXXT GREY 2 CM RETTIFICATO 60x120  
Cod. 141 □

± 20 mm

IMBALLI • PACKAGES • EMBALLAGES • FORMATE









	SCATOLA • BOX • BOITE • KARTON			PALLET • PALLETS • PALETTS • PALETTE		
	pz	m <sup>q</sup>	kg	box	m <sup>q</sup>	kg
60x120 (20mm)	1	0,72	31,50	30	21,60	945,00



Pezzi speciali • Special trims • Pièces spéciales • Formstücke

Battiscopa	40 8,55 kg	20 8,55 kg
	<b>290917</b> NEXXT TAUPE RETTIFICATO BATTISCOPA 5x30 Cod. <b>116</b> △	<b>290921</b> NEXXT TAUPE RETTIFICATO BATTISCOPA 5x60 Cod. <b>121</b> △
	<b>290919</b> NEXXT MUD RETTIFICATO BATTISCOPA 5x30 Cod. <b>116</b> △	<b>290923</b> NEXXT MUD RETTIFICATO BATTISCOPA 5x60 Cod. <b>121</b> △
	<b>290918</b> NEXXT IVORY RETTIFICATO BATTISCOPA 5x30 Cod. <b>116</b> △	<b>290922</b> NEXXT IVORY RETTIFICATO BATTISCOPA 5x60 Cod. <b>121</b> △
	<b>290920</b> NEXXT GREY RETTIFICATO BATTISCOPA 5x30 Cod. <b>116</b> △	<b>290924</b> NEXXT GREY RETTIFICATO BATTISCOPA 5x60 Cod. <b>121</b> △



CARATTERISTICHE DI QUALITÀ Quality characteristics Caractéristiques de qualité Qualitätseigenschaften	NORMA Norm Norme Norme	REQUISITO NORMA Required standards Valeur prescrite selon la norme Normvorgabe	RISULTATO Result Résultat Ergebniss
 Assorbimento d'acqua Water absorption of the body Absorption d'eau de support Wasseraufnahme des Scherbens	ISO 10545-3	≤ 0,5	Conforme Conformity Conforme Gemäss
 Resistenza a flessione Breaking strength Résistance à la flexion Biegefestigkeit	ISO 10545-4	≥ 35 N/mm <sup>2</sup>	Conforme Conformity Conforme Gemäss
 Resistenza all'abrasione Abrasion resistance Resistance à l'abrasion Abriebbeständigkeit	ISO 10545-7	IVORY - GREY - TAUPE	PEI V
		MUD	PEI IV
 Resistenza al gelo Frost resistance Résistance au gel Frostbeständigkeit	ISO 10545-12	Nessun campione deve presentare rotture o alterazioni apprezzabili alla superficie No samples must show ruptures or noticeable surface alteration Aucuns enchantions doit présenter ruptures ou altérations appréciables de la surface Keines der Muster sollte Risse oder sichtbare Fehler der Oberflaeche zeigen	Conforme Conformity Conforme Gemäss
 Resistenza all'attacco chimico Chemical resistance Résistance à l'attaque chimique Beständigkeit gegen chemikalien	ISO 10545-13	Nessun campione deve presentare rotture o alterazioni apprezzabili alla superficie No samples must show ruptures or noticeable surface alteration Aucuns enchantions doit présenter ruptures ou altérations appréciables de la surface Keines der Muster sollte Risse oder sichtbare Fehler der Oberflaeche zeigen	Conforme Conformity Conforme Gemäss
 Resistenza agli sbalzi termici Thermal shock resistance Resistance aux écarts de température Temperaturwechselbeständigkeit	ISO 10545-5		Conforme Conformity Conforme Gemäss
 Resistenza scivolosità Sliding resistance Resistance au glissement Rutschfestigkeit	DIN 51130 R	Nexxt Rettificato	R10
		Nexxt R11 Rettificato - 20 mm	R11
 Resistenza scivolosità Sliding resistance Resistance au glissement Rutschfestigkeit	DIN 51097 (A+B+C)	Nexxt Rettificato	A+B
		Nexxt R11 Rettificato - 20 mm	A+B+C
 Coefficiente d'attrito dinamico Wet dynamic coefficient of friction Coefficient de friction dynamique Reibungskoeffizient Schlüfrigkeit (in Bewegung)	Bot 3000 E	DCOF ≥ 0,42	> 0,42
 Significativa variazione Significant variation Variation important Bedeutsam Abweichung			V3

 V1 Aspetto uniforme Uniform appearance Aspect uniforme Einheitliches Aussehen	 V2 Lieve variazione Slight variation Légère variation Geringe Abweichung	 V3 Significativa variazione Significant variation Variation important Bedeutsam Abweichung	 V4 Forte stonizzazione Substantial variation Effet dénuancé très accentué Akzentuierte Variation
---	--	--	--

**PER UNA POSA OTTIMALE DEL PRODOTTO CONSIGLIAMO SEMPRE DI MESCOLARE ALMENO TRE SCATOLE DI MATERIALE.**

For the best product laying results, material from at least three boxes should be mixed.

Pour une pose excellente, nous recommandons toujours de mélanger le contenu d'au moins trois boîtes.

Für eine optimale Verlegung des Erzeugnisses empfehlen wir stets, mindestens drei Packungen Material anzumischen.

**EVENTUALI IMPERFEZIONI NELLA CONTINUITÀ DELLE RIGHE RIENTRANO NELLE TOLLERANZE E NON POSSONO ESSERE CONSIDERATE DIFETTI.**

Any imperfections in the continuity of the lines of the structure are within tolerances and cannot be claimed as defects.

Les éventuelles imperfections dans la continuité des lignes de la structure sont dans les tolérances et ne peuvent être invoquées comme défauts.

Eventuelle Unvollkommenheit in der Kontinuität der Linien der Struktur liegen innerhalb der Toleranzen und können nicht als Mängel reklamiert werden.



Tipologia  
Type  
Typologie  
Typ  
Gres porcellanato smaltato  
Glazed porcelain  
Grès cérame émaille  
Feinsteinzeug glasiert

Formati R10  
Sizes  
Formats  
Formate  
60x120  
60x60  
30x60  
30x30  
10x30

Spessore  
Thickness  
Épaisseur  
Stärke  
9 mm

Resistenza scivolosità  
Sliding resistance  
Resistance au glissement  
Rutschfestigkeit  
R9

Grado di variazione cromatica  
Degree of colour change  
Degré de variation chromatique  
Grad der Farbabweichung  
V3



**601278**  
NEW ARABESCATO NATURALE  
RETTIFICATO 60x120  
Cod. **94** □

**601279**  
ICONIC BLUE LAPPATO  
RETTIFICATO 60x120  
Cod. **103** □



**606223**  
NEW ARABESCATO NATURALE  
RETTIFICATO 60x60  
Cod. **79** □

**606224**  
NEW ARABESCATO LAPPATO  
RETTIFICATO 60x60  
Cod. **93** □



**490687**  
NEW ARABESCATO NATURALE  
RETTIFICATO 30x60  
Cod. **76** □

**490688**  
NEW ARABESCATO LAPPATO  
RETTIFICATO 30x60  
Cod. **85** □

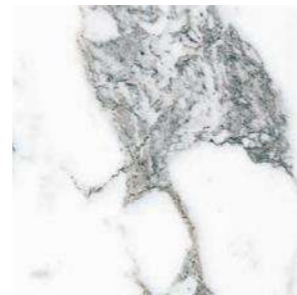

**041208**  
NEW ARABESCATO NATURALE RETTIFICATO  
30x30 Cod. **78** □

**041209**  
NEW ARABESCATO LAPPATO RETTIFICATO  
30x30 Cod. **90** □



**103119**  
NEW ARABESCATO NATURALE  
RETTIFICATO 10x30  
Cod. **77** □

**103120**  
NEW ARABESCATO LAPPATO  
RETTIFICATO 10x30  
Cod. **93** □

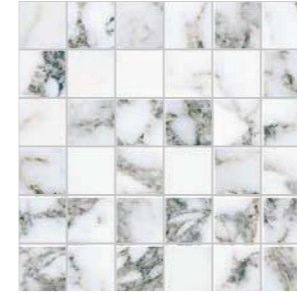

**041240**  
NEW ARABESCATO NATURALE  
MOSAICO 5x5 SU RETE 30x30  
Cod. **24** ○

**041241**  
NEW ARABESCATO LAPPATO  
MOSAICO 5x5 SU RETE 30x30  
Cod. **31** ○

6  
9,30 kg

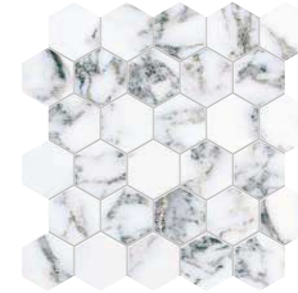

**041242**  
NEW ARABESCATO NATURALE  
MOSAICO ESAGONO SU RETE 27x28  
Cod. **136** ○

**041243**  
NEW ARABESCATO LAPPATO  
MOSAICO ESAGONO SU RETE 27x28  
Cod. **49** ○

6  
8,90 kg



**041228**  
NEW ARABESCATO NATURALE  
MOSAICO HB SU RETE 28x32  
Cod. **45** ○

**041229**  
NEW ARABESCATO LAPPATO  
MOSAICO HB SU RETE 28x32  
Cod. **48** ○

6  
10,20 kg



**041222**  
NEW ARABESCATO NATURALE  
MOSAICO ESAGONO INTARSIO SU RETE 20,7x27  
Cod. **57** ○

**041223**  
NEW ARABESCATO LAPPATO  
MOSAICO ESAGONO INTARSIO SU RETE 20,7x27  
Cod. **72** ○

6  
6,50 kg



**380299**  
NEW ARABESCATO NATURALE  
BORDURA MURETTO 7x30  
Cod. **28** ○

**380300**  
NEW ARABESCATO LAPPATO  
BORDURA MURETTO LAPPATO 7x30  
Cod. **28** ○

10  
3,60 kg



**380293**  
NEW ARABESCATO NATURALE  
LONDON 5x30  
Cod. **33** ○

**380294**  
NEW ARABESCATO LUCIDO  
LONDON 5x30  
Cod. **33** ○

24  
6,11 kg

IMBALLI • PACKAGES • EMBALLAGES • FORMATE

	SCATOLA • BOX • BOITE • KARTON			PALLET • PALLETTS • PALETTS • PALETTE		
	pz	mq	kg	box	mq	kg
<b>60x120</b>	2	1,44	30,20	30	43,20	906,00
<b>60x60</b>	3	1,08	22,60	40	43,20	904,00
<b>30x60</b>	6	1,08	22,60	40	43,20	904,00
<b>30x30</b>	11	0,99	21,20	46	45,54	975,00
<b>10x30</b>	20	0,60	12,90	60	36,00	774,00



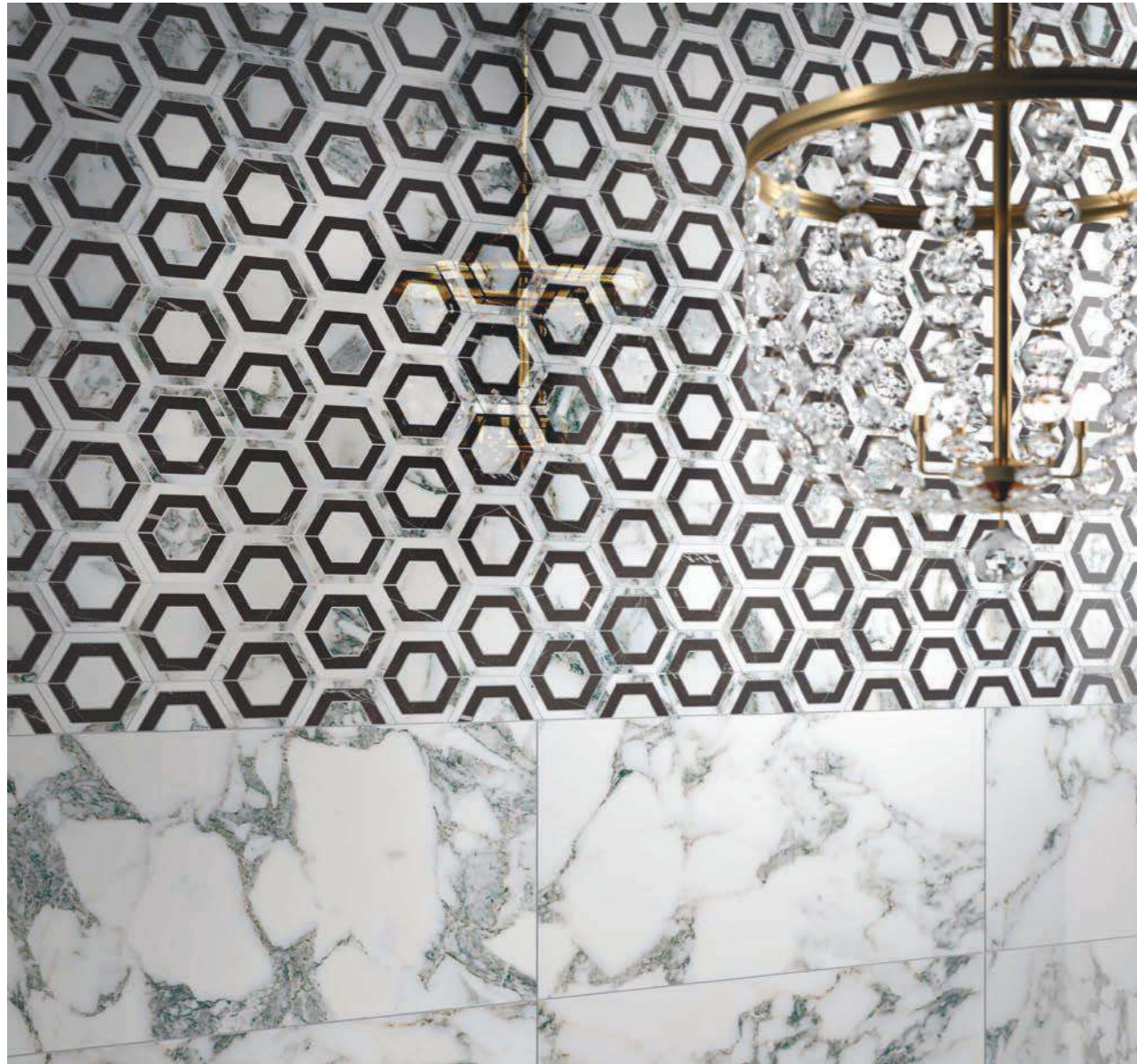

## new arabescato RETT. LAPPATO

La finitura lappata è consigliata per uso rivestimento o per pavimenti da bagno in ambito residenziale. Nello specifico il tipo di pavimentazione deve essere non soggetta ad eccessive sollecitazioni e mai a diretto contatto con aree esterne. Come si verifica comunemente nelle pietre naturali l'eventuale presenza di puntini sulla superficie o di qualche disuniformità della lucentezza sono da considerare caratteristiche del prodotto derivanti dalla lavorazione a cui viene sottoposto.

The polished finish is recommended for wall coverings or for the floors of residential bathrooms. Specifically, floor coverings in this material must not be subjected to excessively heavy traffic and must never be in direct contact with outdoor areas. As is often the case with natural stones, any spots on the surface or any unevenness in shine are typical characteristics of the product, deriving from the process used.

La finitura polie est recommandée pour le revêtement sol et mur des salles de bains résidentielles. Notamment, ce type de carreau au sol ne doit pas être exposé à des contraintes excessives, et il ne doit jamais être en contact direct avec des zones extérieures. Comme cela est souvent le cas pour les pierres naturelles, les micro trous éventuellement présents à la surface du produit ou l'hétérogénéité de son éclat forment des caractéristiques propres au façonnage.

Die polierte Oberfläche wird für Wandverkleidungen und Bodenbeläge in Privatbädern empfohlen. Der Bodenbelag darf keinen starken Beanspruchungen ausgesetzt sein und keinen direkten Kontakt zu Außenbereichen haben. Wie bei Natursteinen üblich, kann die Oberfläche Körnungen oder einen unregelmäßigen Glanz aufweisen. Diese Merkmale sind typische, beabsichtigte Produkteigenschaften, die durch das Bearbeitungsverfahren hervorgerufen werden.

Pezzi speciali • Special trims • Pièces spéciales • Formstücke

Battiscopa	44 22,40 kg	18 17,10 kg
	<b>290762</b> NEW ARABESCATO NATURALE BATTISCOPA 7x30 Cod. <b>116</b> △	<b>290768</b> NEW ARABESCATO NATURALE BATTISCOPA 7x60 Cod. <b>121</b> △
	<b>290763</b> NEW ARABESCATO LAPPATO BATTISCOPA 7x30 Cod. <b>22</b> △	<b>290769</b> NEW ARABESCATO LAPPATO BATTISCOPA 7x60 Cod. <b>26</b> △

CARATTERISTICHE DI QUALITÀ Quality characteristics Caractéristiques de qualité Qualitätseigenschaften	NORMA Norm Norme Norme	REQUISITO NORMA Required standards Valeur prescrite selon la norme Normvorgabe	RISULTATO Result Résultat Ergebnis
Assorbimento d'acqua Water absorption of the body Absorption d'eau de support Wasseraufnahme des Scherbens	ISO 10545-3	≤ 0,5	Conforme Conformity Conforme Gemäss
Resistenza a flessione Breaking strenght Résistance à la flexion Biegefestigkeit	ISO 10545-4	≥ 35 N/mm <sup>2</sup>	Conforme Conformity Conforme Gemäss
Resistenza all'abrasione Abrasion resistance Résistance à l'abrasion Abriebbeständigkeit	ISO 10545-7	New Arabescato Rettificato	PEI IV
Resistenza al gelo Frost resistance Résistance au gel Frostbeständigkeit	ISO 10545-12	Nessun campione deve presentare rotture o alterazioni apprezzabili alla superficie No samples must show ruptures or noticeable surface alteration Aucuns enchantions doit présenter ruptures ou altérations appréciables de la surface Keines der Muster sollte Risse oder sichtbare Fehler der Oberfläche zeigen	Conforme Conformity Conforme Gemäss
Resistenza all'attacco chimico Chemical resistance Résistance à l'attaque chimique Beständigkeit gegen chemikalien	ISO 10545-13	New Arabescato Naturale New Arabescato Lappato	GA GLA GA GLB
Resistenza agli sbalzi termici Thermal shock resistance Résistance aux écarts de température Temperaturwechselbeständigkeit	ISO 10545-5		Conforme Conformity Conforme Gemäss
Resistenza scivolosità Sliding resistance Résistance au glissement Rutschfestigkeit	DIN 51130 R		R9
Significativa variazione Significant variation Variation important Bedeutsam Abweichung		New Arabescato Rettificato	V3

Aspetto uniforme  
Uniform appearance  
Aspect uniforme  
Einheitliches Aussehen  
**V1**

Lieve variazione  
Slight variation  
Légère variation  
Geringe Abweichung  
**V2**

Significativa variazione  
Significant variation  
Variation important  
Bedeutsam Abweichung  
**V3**

Forte stonalizzazione  
Substantial variation  
Effet dénuancé très accentué  
Akzentuierte Variation  
**V4**

**PER UNA POSA OTTIMALE DEL PRODOTTO CONSIGLIAMO SEMPRE DI MESCOLARE ALMENO TRE SCATOLE DI MATERIALE.**

For the best product laying results, material from at least three boxes should be mixed.

Pour une pose excellente, nous recommandons toujours de mélanger le contenu d'au moins trois boîtes.

Für eine optimale Verlegung des Erzeugnisses empfehlen wir stets, mindestens drei Packungen Material anzumischen.



Tipologia  
Type  
Typologie  
Typ  
Gres porcellanato smaltato  
Glazed porcelain  
Grès cérame émaille  
Feinsteinzeug glasiert

Formati  
Sizes  
Formats  
Formate  
60x120  
60x60  
30x60  
10x30

Spessore  
Thickness  
Épaisseur  
Stärke  
9 mm

Resistenza scivolosità  
Sliding resistance  
Resistance au glissement  
Rutschfestigkeit  
R9

Grado di variazione cromatica  
Degree of colour change  
Degré de variation chromatique  
Grad der Farbabweichung  
V3



**601351**  
NEW MOONLIGHT NATURALE  
RETTIFICATO 60x120  
Cod. **94** □

**601352**  
NEW MOONLIGHT LAPPATO  
RETTIFICATO 60x120  
Cod. **103** □

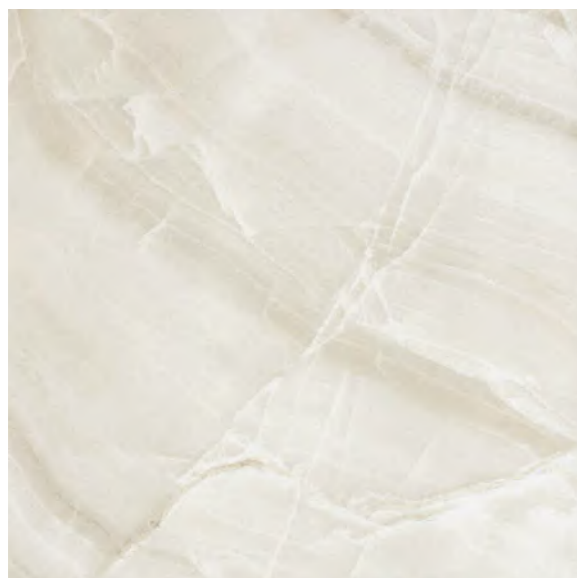

**606306**  
NEW MOONLIGHT NATURALE  
RETTIFICATO 60x60  
Cod. **79** □

**606307**  
NEW MOONLIGHT LAPPATO  
RETTIFICATO 60x60  
Cod. **93** □



**490883**  
NEW MOONLIGHT NATURALE  
RETTIFICATO 30x60  
Cod. **76** □

**490884**  
NEW MOONLIGHT LAPPATO  
RETTIFICATO 30x60  
Cod. **85** □



**103177**  
NEW MOONLIGHT NATURALE  
RETTIFICATO 10x30  
Cod. **77** □

**103178**  
NEW MOONLIGHT LAPPATO  
RETTIFICATO 10x30  
Cod. **93** □

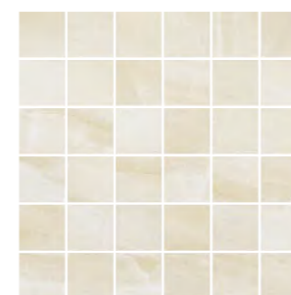

9,30 kg

**041629**  
NEW MOONLIGHT NATURALE  
MOSAICO 5x5 SU RETE 30x30  
Cod. **24** ○

**041627**  
NEW MOONLIGHT LAPPATO  
MOSAICO 5x5 SU RETE 30x30  
Cod. **31** ○



8,90 kg

**041557**  
NEW MOONLIGHT NATURALE  
MOSAICO ESAGONO SU RETE 27x28  
Cod. **136** ○

**041558**  
NEW MOONLIGHT LAPPATO  
MOSAICO ESAGONO SU RETE 27x28  
Cod. **49** ○



10,20 kg

**041525**  
NEW MOONLIGHT NATURALE  
MOSAICO HB SU RETE 28x32  
Cod. **45** ○

**041526**  
NEW MOONLIGHT LAPPATO  
MOSAICO HB SU RETE 28x32  
Cod. **48** ○



6,50 kg

**041589**  
NEW MOONLIGHT NATURALE  
MOSAICO ESAGONO INTARSIO SU RETE 20,7x27  
Cod. **57** ○

**041590**  
NEW MOONLIGHT LAPPATO  
MOSAICO ESAGONO INTARSIO SU RETE 20,7x27  
Cod. **72** ○

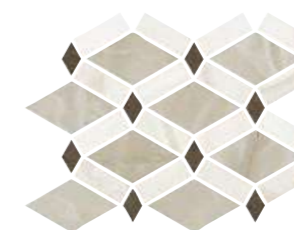

8,90 kg

**041573**  
NEW MOONLIGHT NATURALE  
MOSAICO FANCY SU RETE 24x30  
Cod. **51** ○

**041574**  
NEW MOONLIGHT LAPPATO  
MOSAICO FANCY SU RETE 24x30  
Cod. **71** ○

**IMBALLI • PACKAGES • EMBALLAGES • FORMATE**

	SCATOLA • BOX • BOITE • KARTON			PALLET • PALLETS • PALETTS • PALETTE		
	<i>pz</i>	<i>mq</i>	<i>kg</i>	<i>box</i>	<i>mq</i>	<i>kg</i>
<b>60x120</b>	2	1,44	30,20	30	43,20	906,00
<b>60x60</b>	3	1,08	22,60	40	43,20	904,00
<b>30x60</b>	6	1,08	22,60	40	43,20	975,00
<b>10x30</b>	20	0,60	12,90	60	36,00	774,00



## new moonlight RETT. LAPPATO

La finitura lappata è consigliata per uso rivestimento o per pavimenti da bagno in ambito residenziale. Nello specifico il tipo di pavimentazione deve essere non soggetta ad eccessive sollecitazioni e mai a diretto contatto con aree esterne. Come si verifica comunemente nelle pietre naturali l'eventuale presenza di puntini sulla superficie o di qualche disuniformità della lucentezza sono da considerare caratteristiche del prodotto derivanti dalla lavorazione a cui viene sottoposto.

The polished finish is recommended for wall coverings or for the floors of residential bathrooms. Specifically, floor coverings in this material must not be subjected to excessively heavy traffic and must never be in direct contact with outdoor areas. As is often the case with natural stones, any spots on the surface or any unevenness in shine are typical characteristics of the product, deriving from the process used.

La finitura polie est recommandée pour le revêtement sol et mur des salles de bains résidentielles. Notamment, ce type de carreau au sol ne doit pas être exposé à des contraintes excessives, et il ne doit jamais être en contact direct avec des zones extérieures. Comme cela est souvent le cas pour les pierres naturelles, les micro trous éventuellement présents à la surface du produit ou l'hétérogénéité de son éclat forment des caractéristiques propres au façonnage.

Die polierte Oberfläche wird für Wandverkleidungen und Bodenbeläge in Privatbädern empfohlen. Der Bodenbelag darf keinen starken Beanspruchungen ausgesetzt sein und keinen direkten Kontakt zu Außenbereichen haben. Wie bei Natursteinen üblich, kann die Oberfläche Körnungen oder einen unregelmäßigen Glanz aufweisen. Diese Merkmale sind typische, beabsichtigte Produkteigenschaften, die durch das Bearbeitungsverfahren hervorgerufen werden.

Pezzi speciali • Special trims • Pièces spéciales • Formstücke

Battiscopa

44  
22,40 kg

18  
17,10 kg

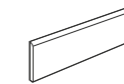

**290894**  
NEW MOONLIGHT NATURALE  
BATTISCOPA 7x30  
Cod. **116** △

**290895**  
NEW MOONLIGHT LAPPATO  
BATTISCOPA 7x30  
Cod. **22** △

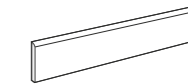

**290910**  
NEW MOONLIGHT NATURALE  
BATTISCOPA 7x60  
Cod. **121** △

**290911**  
NEW MOONLIGHT LAPPATO  
BATTISCOPA 7x60  
Cod. **26** △

CARATTERISTICHE DI QUALITÀ Quality characteristics Caractéristiques de qualité Qualitätseigenschaften	NORMA Norm Norme Norme	REQUISITO NORMA Required standards Valeur prescrite selon la norme Normvorgabe	RISULTATO Result Résultat Ergebniss
Assorbimento d'acqua Water absorption of the body Absorption d'eau de support Wasseraufnahme des Scherbens	ISO 10545-3	≤ 0,5	Conforme Conformity Conforme Gemäss
Resistenza a flessione Breaking strenght Résistance à la flexion Biegefestigkeit	ISO 10545-4	≥ 35 N/mm <sup>2</sup>	Conforme Conformity Conforme Gemäss
Resistenza all'abrasione Abrasion resistance Résistance à l'abrasion Abriebbeständigkeit	ISO 10545-7	NEW MOONLIGHT Rettificato	PEI IV
Resistenza al gelo Frost resistance Résistance au gel Frostbeständigkeit	ISO 10545-12	Nessun campione deve presentare rotture o alterazioni apprezzabili alla superficie No samples must show ruptures or noticeable surface alteration Aucuns enchantions doit présenter ruptures ou altérations appréciables de la surface Keines der Muster sollte Risse oder sichtbare Fehler der Oberfläche zeigen	Conforme Conformity Conforme Gemäss
Resistenza all'attacco chimico Chemical resistance Résistance à l'attaque chimique Beständigkeit gegen chemikalien	ISO 10545-13	NEW MOONLIGHT Naturale NEW MOONLIGHT Lappato	GA GLA GA GLB
Resistenza agli sbalzi termici Thermal shock resistance Résistance aux écarts de température Temperaturwechselbeständigkeit	ISO 10545-5		Conforme Conformity Conforme Gemäss
Resistenza scivolosità Sliding resistance Résistance au glissement Rutschfestigkeit	DIN 51130 R		R9
Significativa variazione Significant variation Variation important Bedeutsam Abweichung		NEW MOONLIGHT Rettificato	V3

Aspetto uniforme  
Uniform appearance  
Aspect uniforme  
Einheitliches Aussehen  
**V1**

Lieve variazione  
Slight variation  
Légère variation  
Geringe Abweichung  
**V2**

Significativa variazione  
Significant variation  
Variation important  
Bedeutsam Abweichung  
**V3**

Forte stonalizzazione  
Substantial variation  
Effet dénuancé très accentué  
Akzentuierte Variation  
**V4**

**PER UNA POSA OTTIMALE DEL PRODOTTO CONSIGLIAMO SEMPRE DI MESCOLARE ALMENO TRE SCATOLE DI MATERIALE.**

For the best product laying results, material from at least three boxes should be mixed.

Pour une pose excellente, nous recommandons toujours de mélanger le contenu d'au moins trois boîtes.

Für eine optimale Verlegung des Erzeugnisses empfehlen wir stets, mindestens drei Packungen Material anzumischen.



Tipologia  
Type  
Typologie  
Typ  
Gres porcellanato smaltato  
Glazed porcelain  
Grès cérame emaille  
Feinsteinzeug glasiert

Formati  
Sizes  
Formats  
Formate  
60x120  
60x60  
30x60  
10x30

Spessore  
Thickness  
Épaisseur  
Stärke  
9 mm

Resistenza scivolosità  
Sliding resistance  
Resistance au glissement  
Rutschfestigkeit  
R9

Grado di variazione cromatica  
Degree of colour change  
Degré de variation chromatique  
Grad der Farbabweichung  
V3



**0601321**  
NEW STYLE DARK  
RETTIFICATO 60x120  
Cod. **94** □



**0606267**  
NEW STYLE DARK  
RETTIFICATO 60x60  
Cod. **87** □



**0490818**  
NEW STYLE DARK  
RETTIFICATO 30x60  
Cod. **79** □



**0103148**  
NEW STYLE DARK  
RETTIFICATO 10x30  
Cod. **87** □

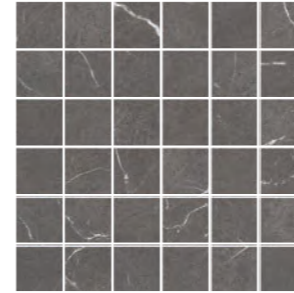

6  
9,70 kg

**0041420**  
NEW STYLE DARK  
MOSAICO 5x5 SU RETE 30x30  
Cod. **26** ○

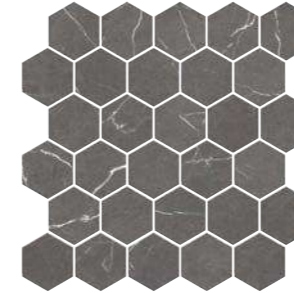

6  
8,90 kg

**0041428**  
NEW STYLE DARK  
MOSAICO ESAGONO SU RETE 27x28  
Cod. **45** ○



6  
9,80 kg

**0041436**  
NEW STYLE DARK  
MOSAICO HB SU RETE 28x32  
Cod. **46** ○



6  
9,80 kg

**0041444**  
NEW STYLE DARK  
MOSAICO ANTIQUE LUX SU RETE 30x30  
Cod. **69** ○

IMBALLI • PACKAGES • EMBALLAGES • FORMATE

	SCATOLA • BOX • BOITE • KARTON			PALLET • PALLETS • PALETTS • PALETTE		
	<i>pz</i>	<i>mq</i>	<i>kg</i>	<i>box</i>	<i>mq</i>	<i>kg</i>
<b>60x120</b>	2	1,44	28,70	30	43,20	861,00
<b>60x60</b>	3	1,08	21,50	40	43,20	861,00
<b>30x60</b>	6	1,08	21,50	40	43,20	861,00
<b>10x30</b>	20	0,60	11,40	60	36,00	684,00



Pezzi speciali • Special trims • Pièces spéciales • Formstücke

Battiscopa

44  
17,20 kg

18  
14,80 kg

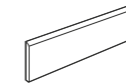

**0290836**  
NEW STYLE DARK  
BATTISCOPA 7x30  
Cod. **19** △

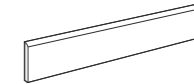

**0290844**  
NEW STYLE DARK  
BATTISCOPA 7x60  
Cod. **23** △

CARATTERISTICHE DI QUALITÀ Quality characteristics Caractéristiques de qualité Qualitätseigenschaften	NORMA Norm Norme Norme	REQUISITO NORMA Required standards Valeur prescrite selon la norme Normvorgabe	RISULTATO Result Résultat Ergebniss
Assorbimento d'acqua Water absorption of the body Absorption d'eau de support Wasseraufnahme des Scherbens	ISO 10545-3	≤ 0,5	Conforme Conformity Conforme Gemäss
Resistenza a flessione Breaking strenght Résistance à la flexion Biegefestigkeit	ISO 10545-4	≥ 35 N/mm <sup>2</sup>	Conforme Conformity Conforme Gemäss
Resistenza all'abrasione Abrasion resistance Resistance a l'abrasion Abriebbeständigkeit	ISO 10545-7	≤ 175 mm <sup>3</sup>	Conforme Conformity Conforme Gemäss
Resistenza al gelo Frost resistance Résistance au gel Frostbeständigkeit	ISO 10545-12	Nessun campione deve presentare rotture o alterazioni apprezzabili alla superficie No samples must show ruptures or noticeable surface alteration Aucuns enchantions doit présenter ruptures ou altérations appréciables de la surface Keines der Muster sollte Risse oder sichtbare Fehler der Oberfläche zeigen	Conforme Conformity Conforme Gemäss
Resistenza all'attacco chimico Chemical resistance Résistance à l'attaque chimique Beständigkeit gegen chemikalien	ISO 10545-13		GA GLA
Resistenza agli sbalzi termici Thermal shock resistance Resistance aux écarts de température Temperaturwechselbeständigkeit	ISO 10545-5		Conforme Conformity Conforme Gemäss
Resistenza scivolosità Sliding resistance Resistance au glissement Rutschfestigkeit	DIN 51130 R		R9
Coefficiente d'attrito dinamico Wet dynamic coefficient of friction Coefficient de friction dynamique Reibungskoeffizient Schlupfrigkeit (in Bewegung)	Bot 3000 E	DCOF ≥ 0,42	> 0,42
Significativa variazione Significant variation Variation important Bedeutsam Abweichung			V3

<b>V1</b> Aspetto uniforme Uniform appearance Aspect uniforme Einheitliches Aussehen	<b>V2</b> Lieve variazione Slight variation Légère variation Geringe Abweichung	<b>V3</b> Significativa variazione Significant variation Variation important Bedeutsam Abweichung	<b>V4</b> Forte stonalizzazione Substantial variation Effet dénuancé très accentué Akzentuierte Variation
--	---	---	---

**PER UNA POSA OTTIMALE DEL PRODOTTO CONSIGLIAMO SEMPRE DI MESCOLARE ALMENO TRE SCATOLE DI MATERIALE.**

For the best product laying results, material from at least three boxes should be mixed.

Pour une pose excellente, nous recommandons toujours de mélanger le contenu d'au moins trois boîtes.

Für eine optimale Verlegung des Erzeugnisses empfehlen wir stets, mindestens drei Packungen Material anzumischen.

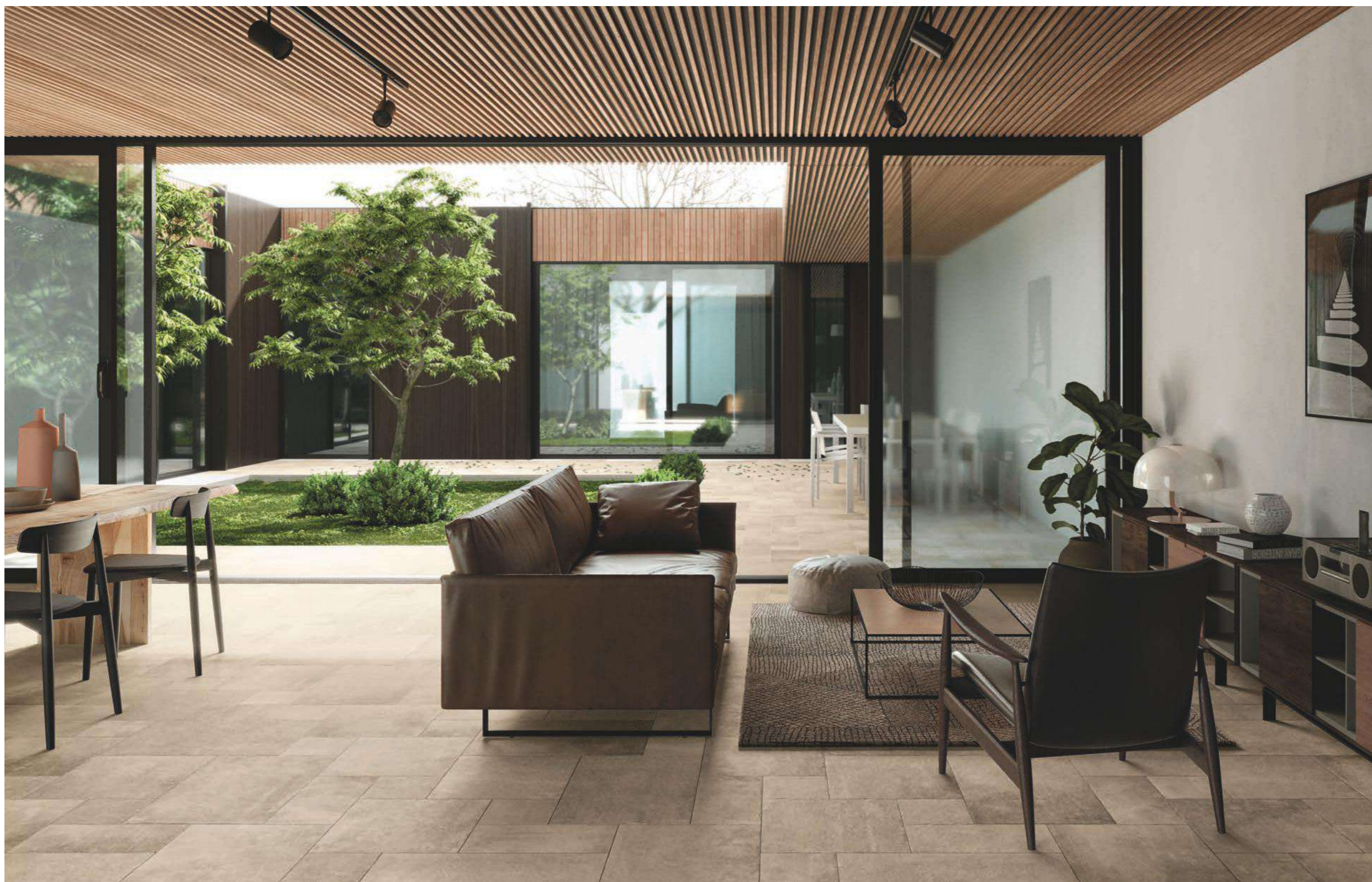

Tipologia  
Type  
Typologie  
Typ  
Gres porcellanato smaltato  
Glazed porcelain  
Grès cérame emaille  
Feinsteinzeug glasiert

Formati R10  
Sizes  
Formats  
Formate  
40,8x61,4  
40,8x40,8  
20,3x40,8  
20,3x20,3  
10,3x20,3  
MIX BOX

Spessore  
Thickness  
Épaisseur  
Stärke  
9,8 mm

Resistenza scivolosità  
Sliding resistance  
Resistance au glissement  
Rutschfestigkeit  
R10 / A+B

Grado di variazione cromatica  
Degree of colour change  
Degré de variation chromatique  
Grad der Farbabweichung  
V3



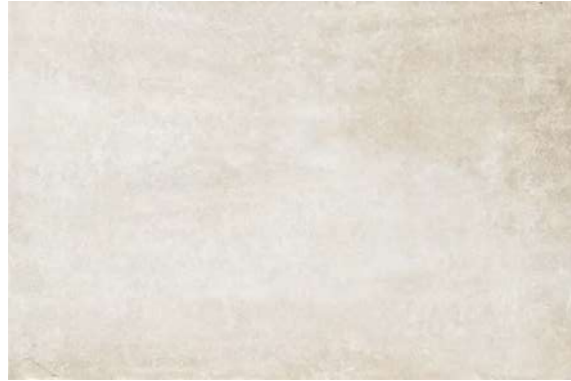

**406009**  
OPUS STONE AVORIO  
NATURALE 40,8x61,4  
Cod. **70** □



**204006**  
OPUS STONE AVORIO  
NATURALE 20,3x40,8  
Cod. **78** □

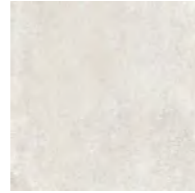

**130071**  
OPUS STONE AVORIO NATURALE 10,3x20,3  
Cod. **96** □



**103108**  
OPUS STONE AVORIO  
NATURALE 10,3x20,3  
Cod. **88** □

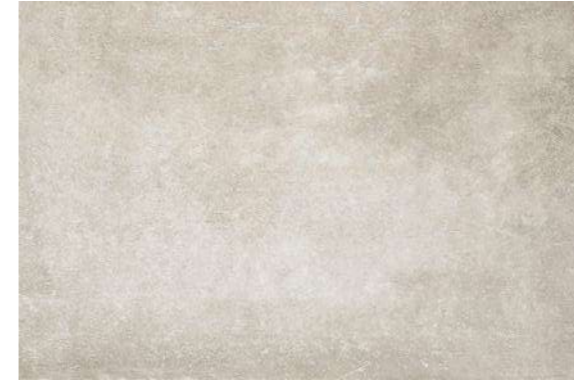

**406018**  
OPUS STONE GRIGIO  
NATURALE 40,8x61,4  
Cod. **70** □



**204009**  
OPUS STONE GRIGIO  
NATURALE 20,3x40,8  
Cod. **78** □



**130074**  
OPUS STONE GRIGIO NATURALE 10,3x20,3  
Cod. **96** □



**103111**  
OPUS STONE GRIGIO  
NATURALE 10,3x20,3  
Cod. **88** □

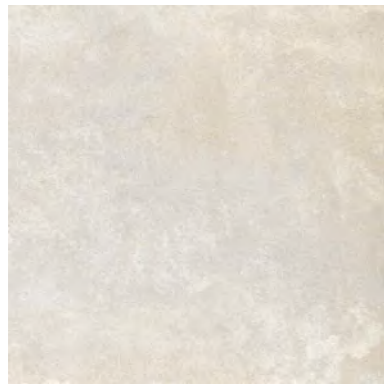

**404009**  
OPUS STONE AVORIO  
NATURALE 40,8x40,8  
Cod. **71** □

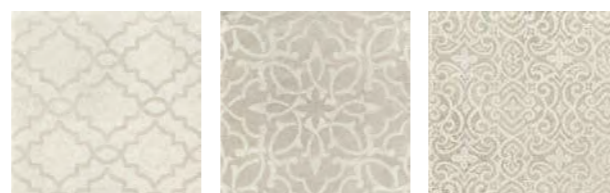
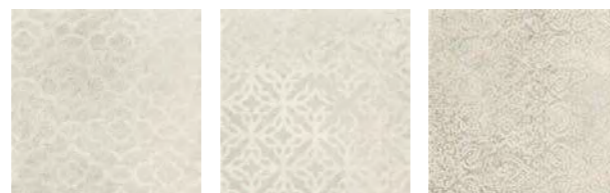
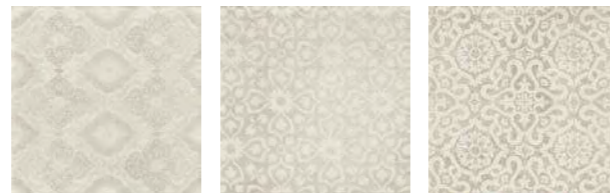

**130077**  
OPUS STONE DECORO GRIGIO / AVORIO  
20,3x20,3  
Cod. **104** □



**404012**  
OPUS STONE GRIGIO  
NATURALE 40,8x40,8  
Cod. **71** □

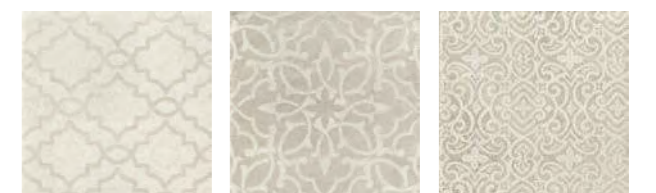
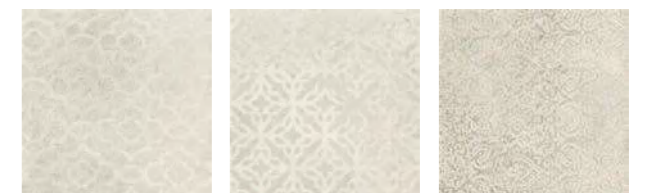
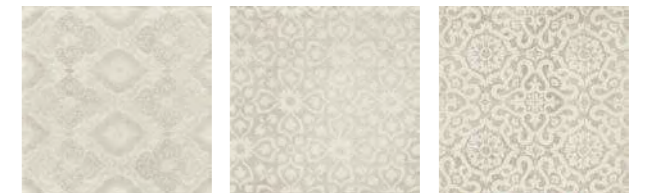

**130077**  
OPUS STONE DECORO GRIGIO / AVORIO  
20,3x20,3  
Cod. **104** □

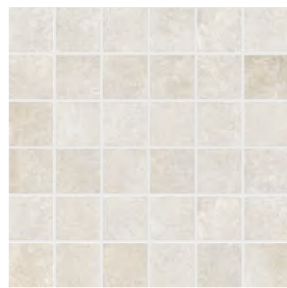

10,70 kg

**041195**  
OPUS STONE AVORIO NATURALE  
MOSAICO 5x5 SU RETE 30x30  
Cod. **26** ○



10,70 kg

**041198**  
OPUS STONE GRIGIO NATURALE  
MOSAICO 5x5 SU RETE 30x30  
Cod. **26** ○

IMBALLI • PACKAGES • EMBALLAGES • FORMATE

	SCATOLA • BOX • BOITE • KARTON			PALLET • PALLETS • PALETTS • PALETTE		
	pz	mq	kg	box	mq	kg
<b>MIX BOX</b>	6	0,75	14,30	44,00	33,00	650,00
<b>40,8x61,4</b>	5	1,253	24,00	48,00	60,14	1.170,00
<b>40,8x40,8</b>	6	0,999	19,10	36,00	35,96	700,00
<b>20,3x40,8</b>	12	0,989	19,10	54,00	53,68	1.050,00
<b>20,3x20,3</b>	24	0,994	19,00	54,00	53,41	1.050,00
<b>10,3x20,3</b>	32	0,640	12,40	60,00	38,40	770,00

IMBALLI • PACKAGES • EMBALLAGES • FORMATE

	SCATOLA • BOX • BOITE • KARTON			PALLET • PALLETS • PALETTS • PALETTE		
	pz	mq	kg	box	mq	kg
<b>MIX BOX</b>	6	0,75	14,30	44,00	33,00	650,00
<b>40,8x61,4</b>	5	1,253	24,00	48,00	60,14	1.170,00
<b>40,8x40,8</b>	6	0,999	19,10	36,00	35,96	700,00
<b>20,3x40,8</b>	12	0,989	19,10	54,00	53,68	1.050,00
<b>20,3x20,3</b>	24	0,994	19,00	54,00	53,41	1.050,00
<b>10,3x20,3</b>	32	0,640	12,40	60,00	38,40	770,00

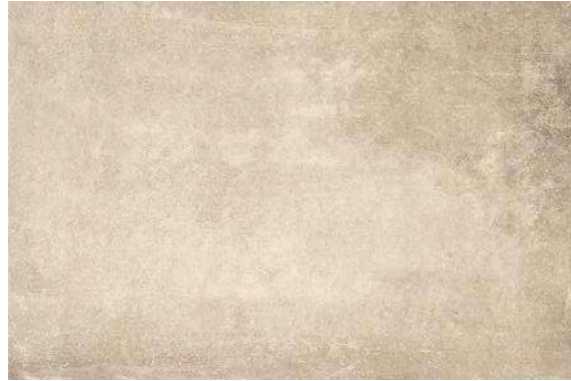

**406012**  
OPUS STONE BEIGE  
NATURALE 40,8x61,4  
Cod. **70** □



**204007**  
OPUS STONE BEIGE  
NATURALE 20,3x40,8  
Cod. **78** □



**130072**  
OPUS STONE BEIGE NATURALE 20,3x20,3  
Cod. **96** □



**103109**  
OPUS STONE BEIGE  
NATURALE 10,3x20,3  
Cod. **88** □



**406021**  
OPUS STONE TORTORA  
NATURALE 40,8x61,4  
Cod. **70** □



**204010**  
OPUS STONE TORTORA  
NATURALE 20,3x40,8  
Cod. **78** □



**130075**  
OPUS STONE TORTORA NATURALE 20,3x20,3  
Cod. **96** □



**103112**  
OPUS STONE TORTORA  
NATURALE 10,3x20,3  
Cod. **88** □



**404010**  
OPUS STONE BEIGE  
NATURALE 40,8x40,8  
Cod. **71** □

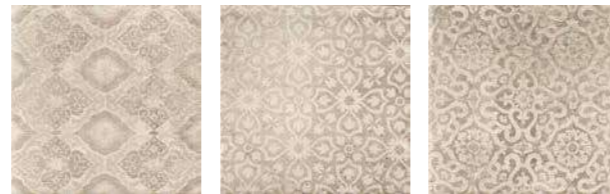

**130078**  
OPUS STONE DECORO BEIGE / TORTORA  
20,3x20,3  
Cod. **104** □



**404013**  
OPUS STONE TORTORA  
NATURALE 40,8x40,8  
Cod. **71** □



**130078**  
OPUS STONE DECORO BEIGE / TORTORA  
20,3x20,3  
Cod. **104** □



10,70 kg

**041196**  
OPUS STONE BEIGE NATURALE  
MOSAICO 5x5 SU RETE 30x30  
Cod. **26** ○



10,70 kg

**041199**  
OPUS STONE TORTORA NATURALE  
MOSAICO 5x5 SU RETE 30x30  
Cod. **26** ○

IMBALLI • PACKAGES • EMBALLAGES • FORMATE

	SCATOLA • BOX • BOITE • KARTON			PALLET • PALLETS • PALETTS • PALETTE		
	pz	mq	kg	box	mq	kg
<b>MIX BOX</b>	6	0,75	14,30	44,00	33,00	650,00
<b>40,8x61,4</b>	5	1,253	24,00	48,00	60,14	1.170,00
<b>40,8x40,8</b>	6	0,999	19,10	36,00	35,96	700,00
<b>20,3x40,8</b>	12	0,989	19,10	54,00	53,68	1.050,00
<b>20,3x20,3</b>	24	0,994	19,00	54,00	53,41	1.050,00
<b>10,3x20,3</b>	32	0,640	12,40	60,00	38,40	770,00

IMBALLI • PACKAGES • EMBALLAGES • FORMATE

	SCATOLA • BOX • BOITE • KARTON			PALLET • PALLETS • PALETTS • PALETTE		
	pz	mq	kg	box	mq	kg
<b>MIX BOX</b>	6	0,75	14,30	44,00	33,00	650,00
<b>40,8x61,4</b>	5	1,253	24,00	48,00	60,14	1.170,00
<b>40,8x40,8</b>	6	0,999	19,10	36,00	35,96	700,00
<b>20,3x40,8</b>	12	0,989	19,10	54,00	53,68	1.050,00
<b>20,3x20,3</b>	24	0,994	19,00	54,00	53,41	1.050,00
<b>10,3x20,3</b>	32	0,640	12,40	60,00	38,40	770,00



**406015**  
OPUS STONE BLU  
NATURALE 40,8x61,4  
Cod. **70** □



**204008**  
OPUS STONE BLU  
NATURALE 20,3x40,8  
Cod. **78** □



**130073**  
OPUS STONE BLU NATURALE 20,3x20,3  
Cod. **96** □



**103110**  
OPUS STONE BLU  
NATURALE 10,3x20,3  
Cod. **88** □



**404011**  
OPUS STONE BLU  
NATURALE 40,8x40,8  
Cod. **71** □



**130076**  
OPUS STONE DECORO BLU 20,3x20,3  
Cod. **104** □



**041197**  
OPUS STONE BLU NATURALE  
MOSAICO 5x5 SU RETE 30x30  
Cod. **26** ○



IMBALLI • PACKAGES • EMBALLAGES • FORMATE

	SCATOLA • BOX • BOITE • KARTON			PALLET • PALLETS • PALETTS • PALETTE		
	pz	mq	kg	box	mq	kg
<b>MIX BOX</b>	6	0,75	14,30	44,00	33,00	650,00
<b>40,8x61,4</b>	5	1,253	24,00	48,00	60,14	1.170,00
<b>40,8x40,8</b>	6	0,999	19,10	36,00	35,96	700,00
<b>20,3x40,8</b>	12	0,989	19,10	54,00	53,68	1.050,00
<b>20,3x20,3</b>	24	0,994	19,00	54,00	53,41	1.050,00
<b>10,3x20,3</b>	32	0,640	12,40	60,00	38,40	770,00



Suggerimenti di posa • Laying proposals • Solutions de pose • Verlegevorschläge

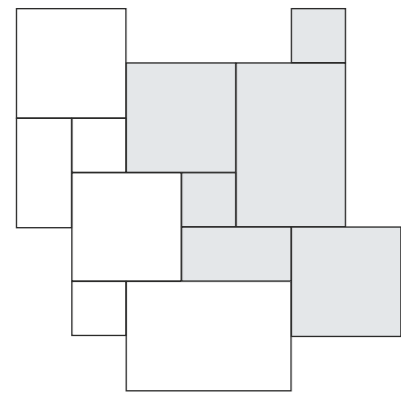

- 406040**  
OPUS STONE AVORIO NATURALE  
MIX BOX  
Cod. 120 □
- 406043**  
OPUS STONE GRIGIO NATURALE  
MIX BOX  
Cod. 120 □
- 406041**  
OPUS STONE BEIGE NATURALE  
MIX BOX  
Cod. 120 □
- 406039**  
OPUS STONE TORTORA NATURALE  
MIX BOX  
Cod. 120 □
- 406042**  
OPUS STONE BLU NATURALE  
MIX BOX  
Cod. 120 □

IMBALLI • PACKAGES • EMBALLAGES • FORMATE	SCATOLA • BOX • BOITE • KARTON			PALLET • PALLETS • PALETTS • PALETTE		
	pz	mq	kg	box	mq	kg
<b>MIX BOX</b>	6	0,75	14,30	44,00	33,00	650,00

Pezzi speciali • Special trims • Pièces spéciales • Formstücke

Battiscopa



15,00 kg

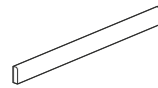

- 290728**  
OPUS STONE AVORIO  
BATTISCOPIA 6,2x40,8  
Cod. 121 △
- 290731**  
OPUS STONE GRIGIO  
BATTISCOPIA 6,2x40,8  
Cod. 121 △
- 290729**  
OPUS STONE BEIGE  
BATTISCOPIA 6,2x40,8  
Cod. 121 △
- 290732**  
OPUS STONE TORTORA  
BATTISCOPIA 6,2x40,8  
Cod. 121 △
- 290730**  
OPUS STONE BLU  
BATTISCOPIA 6,2x40,8  
Cod. 121 △

Lineare ad "L"



10,00 kg

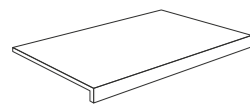

- 490651**  
OPUS STONE AVORIO LINEARE  
AD "L" 33x61,4x5  
Cod. 111 ○
- 490654**  
OPUS STONE GRIGIO LINEARE  
AD "L" 33x61,4x5  
Cod. 111 ○
- 490652**  
OPUS STONE BEIGE LINEARE  
AD "L" 33x61,4x5  
Cod. 111 ○
- 490655**  
OPUS STONE TORTORA LINEARE  
AD "L" 33x61,4x5  
Cod. 111 ○
- 490653**  
OPUS STONE BLU LINEARE  
AD "L" 33x61,4x5  
Cod. 111 ○

Angolare ad "L"



11,00 kg

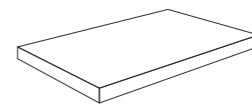

- 490656**  
OPUS STONE AVORIO ANGOLARE  
AD "L" 33x61,4  
Cod. 112 ○
- 490659**  
OPUS STONE GRIGIO ANGOLARE  
AD "L" 33x61,4  
Cod. 112 ○
- 490657**  
OPUS STONE BEIGE ANGOLARE  
AD "L" 33x61,4  
Cod. 112 ○
- 490660**  
OPUS STONE TORTORA ANGOLARE  
AD "L" 33x61,4  
Cod. 112 ○
- 490658**  
OPUS STONE BLU ANGOLARE  
AD "L" 33x61,4  
Cod. 112 ○

Suggerimenti di posa • Laying proposals • Solutions de pose • Verlegevorschläge

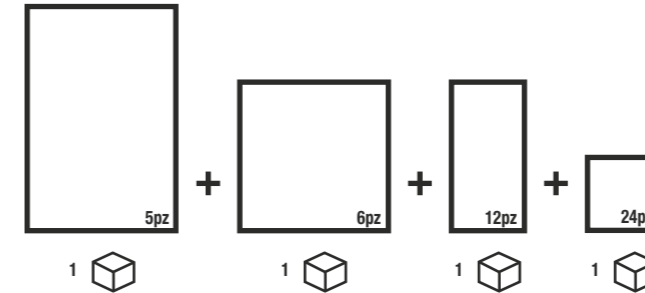

40,8 x 61,4.....33,46 %    20,3 x 40,8.....11,06 %  
40,8 x 40,8.....44,47 %    20,3 x 20,3.....11,01 %

- 600162**  
OPUS STONE AVORIO NATURALE  
COMPO 1  
Cod. 117 □
- 600165**  
OPUS STONE GRIGIO NATURALE  
COMPO 1  
Cod. 117 □
- 600163**  
OPUS STONE BEIGE NATURALE  
COMPO 1  
Cod. 117 □
- 600166**  
OPUS STONE TORTORA NATURALE  
COMPO 1  
Cod. 117 □
- 600164**  
OPUS STONE BLU NATURALE  
COMPO 1  
Cod. 117 □

CARATTERISTICHE DI QUALITÀ Quality characteristics Caractéristiques de qualité Qualitätseigenschaften	NORMA Norm Norme	REQUISITO NORMA Required standards Valeur prescrite selon la norme Normvorgabe	RISULTATO Result Résultat Ergebniss
Assorbimento d'acqua Water absorption of the body Absorption d'eau de support Wasseraufnahme des Scherbens	ISO 10545-3	≤ 0,5	Conforme Conformity Conforme Gemäss
Resistenza a flessione Breaking strenght Résistance à la flexion Biegefestigkeit	ISO 10545-4	≥ 35 N/mm <sup>2</sup>	Conforme Conformity Conforme Gemäss
Resistenza all'abrasione Abrasion resistance Resistance a l'abrasion Abriebbeständigkeit	EN ISO 10545-7		PEI V
Resistenza al gelo Frost resistance Résistance au gel Frostbeständigkeit	ISO 10545-12	Nessun campione deve presentare rotture o alterazioni apprezzabili alla superficie No samples must show ruptures or noticeable surface alteration Aucuns enchantions doit présenter ruptures ou altérations appréciables de la surface Keines der Muster sollte Risse oder sichtbare Fehler der Oberflaeche zeigen	Conforme Conformity Conforme Gemäss
Resistenza all'attacco chimico Chemical resistance Résistance à l'attaque chimique Beständigkeit gegen chemikalien	ISO 10545-13		GA GLA
Resistenza agli sbalzi termici Thermal shock resistance Resistance aux ecart de température Temperaturwechselbeständigkeit	ISO 10545-5		Conforme Conformity Conforme Gemäss
Resistenza scivolosità Sliding resistance Resistance au glissement Rutschfestigkeit	DIN 51130 R	Opus Stone Naturale	R10
Resistenza scivolosità Sliding resistance Resistance au glissement Rutschfestigkeit	DIN 51097 (A+B+C)	Opus Stone Naturale	A+B
Coefficiente d'attrito dinamico Wet dynamic coefficient of friction Coefficient de friction dynamique Reibungskoeffizient Schlüpfgrigkeit (in Bewegung)	Bot 3000 E	DCOF ≥ 0,42	> 0,42
Significativa variazione Significant variation Variation important Bedeutsam Abweichung			V3

<b>V1</b> Aspetto uniforme Uniform appearance Aspect uniforme Einheitliches Aussehen	<b>V2</b> Lieve variazione Slight variation Légère variation Geringe Abweichung	<b>V3</b> Significativa variazione Significant variation Variation important Bedeutsam Abweichung	<b>V4</b> Forte stonalizzazione Substantial variation Effet dénuancé très accentué Akzentuierte Variation
--	---	---	---

**PER UNA POSA OTTIMALE DEL PRODOTTO CONSIGLIAMO SEMPRE DI MESCOLARE ALMENO TRE SCATOLE DI MATERIALE.**  
For the best product laying results, material from at least three boxes should be mixed.  
Pour une pose excellente, nous recommandons toujours de mélanger le contenu d'au moins trois boîtes.  
Für eine optimale Verlegung des Erzeugnisses empfehlen wir stets, mindestens drei Packungen Material anzumischen.



Tipologia  
Type  
Typologie  
Typ  
Gres porcellanato smaltato  
Glazed porcelain  
Grès cérame emaille  
Feinsteinzeug glasiert

Formati  
Sizes  
Formats  
Formate  
120x280  
120x120  
60x120  
60x60  
30x120  
30x60  
10x60  
10x30  
5x20

Spessore  
Thickness  
Épaisseur  
Stärke  
10 mm  
6 mm

Resistenza scivolosità  
Sliding resistance  
Resistance au glissement  
Rutschfestigkeit  
R9

Grado di variazione cromatica  
Degree of colour change  
Degré de variation chromatique  
Grad der Farbabweichung  
V3



# PLATFORM



11,28 kg

**041254**  
PLATFORM POWDER  
MOSAICO 5x5 SU RETE 30x30  
Cod. **24** ○



11,00 kg

**041281**  
PLATFORM POWDER  
MOSAICO LOSANGA SU RETE 28x21,8  
Cod. **71** ○

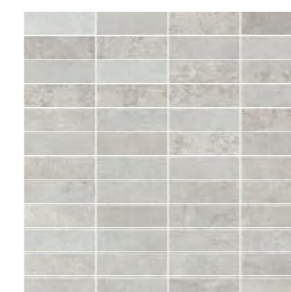

11,00 kg

**041305**  
PLATFORM POWDER  
MOSAICO FRAME 2,5x7,5 SU RETE 30x30  
Cod. **24** ○



**120282**  
PLATFORM POWDER RETTIFICATO 120x280  
Cod. **112** □

± 6 mm



**121211**  
PLATFORM POWDER RETTIFICATO 120x120  
Cod. **106** □

6 mm



**301254**  
PLATFORM POWDER RETTIFICATO 30x120  
Cod. **99** □

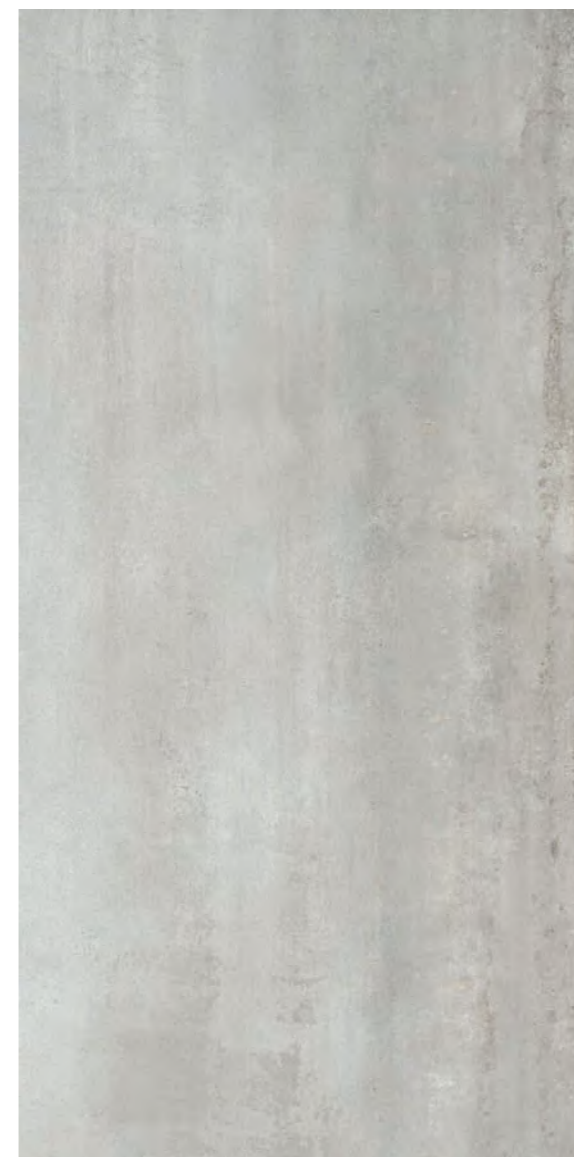

**601282**  
PLATFORM POWDER RETTIFICATO 60x120  
Cod. **94** □

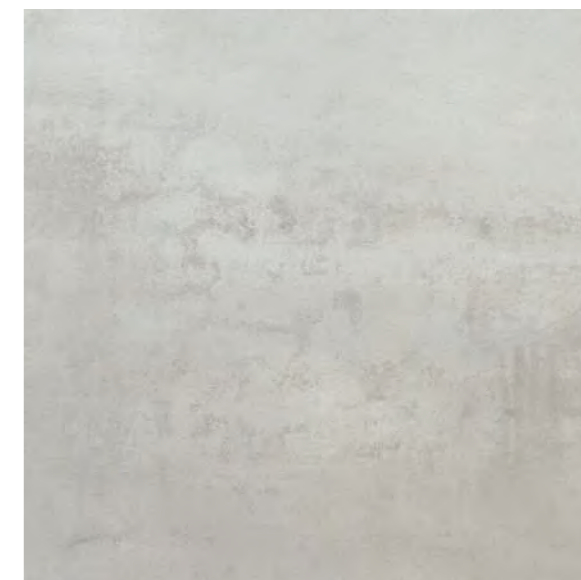

**606233**  
PLATFORM POWDER RETTIFICATO 60x60  
Cod. **79** □



**490693**  
PLATFORM POWDER RETTIFICATO 30x60  
Cod. **76** □



**106024**  
PLATFORM POWDER RETTIFICATO 10x60  
Cod. **83** □



**103127**  
PLATFORM POWDER RETTIFICATO 10x30  
Cod. **77** □



**050233**  
PLATFORM POWDER RETTIFICATO  
5x20 Cod. **93** □

**IMBALLI • PACKAGES • EMBALLAGES • FORMATE**

	SCATOLA • BOX • BOITE • KARTON			PALLET • PALLETS • PALETTS • PALETTE		
	<i>pz</i>	<i>mq</i>	<i>kg</i>	<i>box</i>	<i>mq</i>	<i>kg</i>
<b>120x120</b>	2	2,88	21,80	24	69,12	1.039,00
<b>60x120</b>	2	1,44	32,50	30	43,20	1.000,00
<b>60x60</b>	3	1,08	23,60	40	43,26	965,00
<b>30x120</b>	3	1,08	24,20	42	45,36	1.040,00
<b>30x60</b>	6	1,08	23,90	40	43,20	980,00
<b>10x60</b>	12	0,72	16,00	60	43,20	985,00
<b>10x30</b>	20	0,60	13,00	60	36,00	800,00
<b>5x20</b>	56	0,56	11,70	60	33,60	730,00

	CASSA • CRATE • CAISSE • HOLZKISTE			CAVALLETTO • A-FRAME • CHEVALET • TRANSPORTGESTELL					
	<i>pz</i>	<i>mq</i>	<i>kg</i>	<i>pz</i>	<i>mq</i>	<i>kg</i>			
<b>120x280</b>	1	3,36	47,04	20	67,20	1.090,00	44	147,84	2.220,00

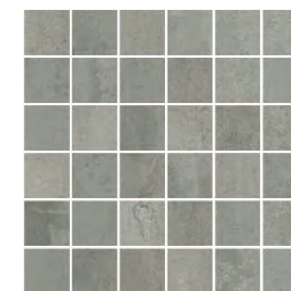

11,28 kg

**041255**  
PLATFORM SAGE  
MOSAICO 5x5 SU RETE 30x30  
Cod. **24** ○



11,00 kg

**041282**  
PLATFORM SAGE  
MOSAICO LOSANGA SU RETE 28x21,8  
Cod. **71** ○



11,00 kg

**041306**  
PLATFORM SAGE  
MOSAICO FRAME 2,5x7,5 SU RETE 30x30  
Cod. **24** ○

**120283**  
PLATFORM SAGE RETTIFICATO 120x280  
Cod. **112** □

± 6 mm



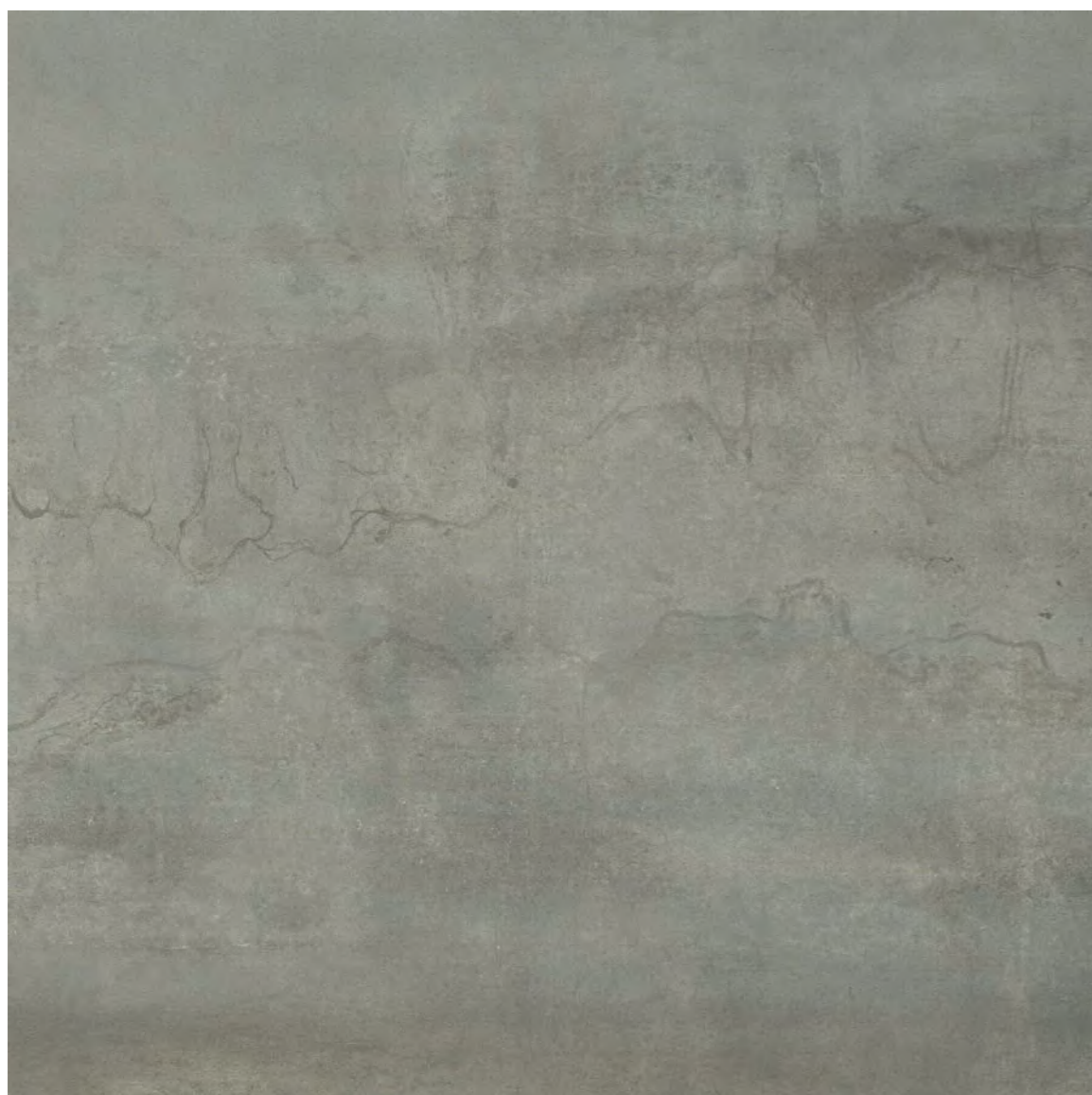

**121212**  
PLATFORM SAGE RETTIFICATO 120x120  
Cod. **106** □

✂ 6 mm



**301255**  
PLATFORM SAGE RETTIFICATO 30x120  
Cod. **99** □

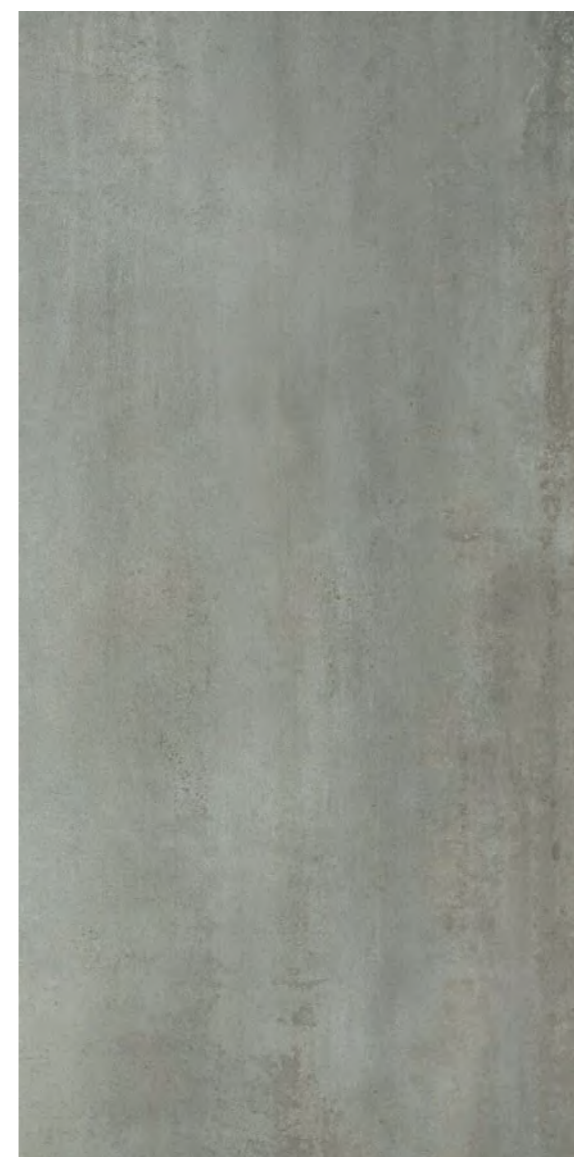

**601283**  
PLATFORM SAGE RETTIFICATO 60x120  
Cod. **94** □



**606234**  
PLATFORM SAGE RETTIFICATO 60x60  
Cod. **79** □



**490694**  
PLATFORM SAGE RETTIFICATO 30x60  
Cod. **76** □



**106025**  
PLATFORM SAGE RETTIFICATO 10x60  
Cod. **83** □



**103128**  
PLATFORM SAGE RETTIFICATO 10x30  
Cod. **77** □



**050234**  
PLATFORM SAGE RETTIFICATO  
5x20 Cod. **93** □

**IMBALLI • PACKAGES • EMBALLAGES • FORMATE**

	SCATOLA • BOX • BOITE • KARTON			PALLET • PALLETS • PALETTS • PALETTE		
	<i>pz</i>	<i>mq</i>	<i>kg</i>	<i>box</i>	<i>mq</i>	<i>kg</i>
<b>120x120</b>	2	2,88	21,80	24	69,12	1.039,00
<b>60x120</b>	2	1,44	32,50	30	43,20	1.000,00
<b>60x60</b>	3	1,08	23,60	40	43,26	965,00
<b>30x120</b>	3	1,08	24,20	42	45,36	1.040,00
<b>30x60</b>	6	1,08	23,90	40	43,20	980,00
<b>10x60</b>	12	0,72	16,00	60	43,20	985,00
<b>10x30</b>	20	0,60	13,00	60	36,00	800,00
<b>5x20</b>	56	0,56	11,70	60	33,60	730,00

	CASSA • CRATE • CAISSE • HOLZKISTE			CAVALLETTO • A-FRAME • CHEVALET • TRANSPORTGESTELL					
	<i>pz</i>	<i>mq</i>	<i>kg</i>	<i>pz</i>	<i>mq</i>	<i>kg</i>			
<b>120x280</b>	1	3,36	47,04	20	67,20	1.090,00	44	147,84	2.220,00



**120280**  
PLATFORM BLUE RETTIFICATO 120x280  
Cod. **112** □

± 6 mm

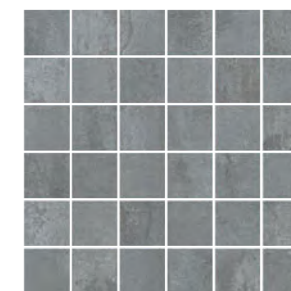

6  
11,28 kg

**041252**  
PLATFORM BLUE  
MOSAICO 5x5 SU RETE 30x30  
Cod. **24** ○



6  
11,00 kg

**041279**  
PLATFORM BLUE  
MOSAICO LOSANGA SU RETE 28x21,8  
Cod. **71** ○



6  
11,00 kg

**041303**  
PLATFORM BLUE  
MOSAICO FRAME 2,5x7,5 SU RETE 30x30  
Cod. **24** ○



**121209**  
PLATFORM BLUE RETTIFICATO 120x120  
Cod. **106** □

⊗ 6 mm



**301252**  
PLATFORM BLUE RETTIFICATO 30x120  
Cod. **99** □



**601280**  
PLATFORM BLUE RETTIFICATO 60x120  
Cod. **94** □



**606231**  
PLATFORM BLUE RETTIFICATO 60x60  
Cod. **79** □



**490691**  
PLATFORM BLUE RETTIFICATO 30x60  
Cod. **76** □



**106022**  
PLATFORM BLUE RETTIFICATO 10x60  
Cod. **83** □



**103125**  
PLATFORM BLUE RETTIFICATO 10x30  
Cod. **77** □



**050231**  
PLATFORM BLUE RETTIFICATO  
5x20 Cod. **93** □

**IMBALLI • PACKAGES • EMBALLAGES • FORMATE**

	SCATOLA • BOX • BOITE • KARTON			PALLET • PALLETS • PALETTS • PALETTE		
	<i>pz</i>	<i>mq</i>	<i>kg</i>	<i>box</i>	<i>mq</i>	<i>kg</i>
<b>120x120</b>	2	2,88	21,80	24	69,12	1.039,00
<b>60x120</b>	2	1,44	32,50	30	43,20	1.000,00
<b>60x60</b>	3	1,08	23,60	40	43,26	965,00
<b>30x120</b>	3	1,08	24,20	42	45,36	1.040,00
<b>30x60</b>	6	1,08	23,90	40	43,20	980,00
<b>10x60</b>	12	0,72	16,00	60	43,20	985,00
<b>10x30</b>	20	0,60	13,00	60	36,00	800,00
<b>5x20</b>	56	0,56	11,70	60	33,60	730,00

	CASSA • CRATE • CAISSE • HOLZKISTE			CAVALLETTO • A-FRAME • CHEVALET • TRANSPORTGESTELL					
	<i>pz</i>	<i>mq</i>	<i>kg</i>	<i>pz</i>	<i>mq</i>	<i>kg</i>			
<b>120x280</b>	1	3,36	47,04	20	67,20	1.090,00	44	147,84	2.220,00



# PLATFORM

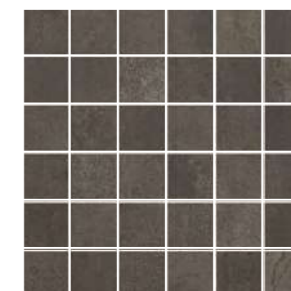

6  
11,28 kg

**041253**  
PLATFORM BRONZE  
MOSAICO 5x5 SU RETE 30x30  
Cod. 24 ○



6  
11,00 kg

**041280**  
PLATFORM BRONZE  
MOSAICO LOSANGA SU RETE 28x21,8  
Cod. 71 ○



6  
11,00 kg

**041304**  
PLATFORM BRONZE  
MOSAICO FRAME 2,5x7,5 SU RETE 30x30  
Cod. 24 ○

**120281**  
PLATFORM BRONZE RETTIFICATO 120x280  
Cod. 112 □

± 6 mm



**121210**  
PLATFORM BRONZE RETTIFICATO 120x120  
Cod. **106** □

± 6 mm



**301253**  
PLATFORM BRONZE RETTIFICATO 30x120  
Cod. **99** □



**601281**  
PLATFORM BRONZE RETTIFICATO 60x120  
Cod. **94** □



**606232**  
PLATFORM BRONZE RETTIFICATO 60x60  
Cod. **79** □



**490692**  
PLATFORM BRONZE RETTIFICATO 30x60  
Cod. **76** □



**106023**  
PLATFORM BRONZE RETTIFICATO 10x60  
Cod. **83** □



**103126**  
PLATFORM BRONZE RETTIFICATO 10x30  
Cod. **77** □



**050232**  
PLATFORM BRONZE RETTIFICATO  
5x20 Cod. **93** □

**IMBALLI • PACKAGES • EMBALLAGES • FORMATE**

	SCATOLA • BOX • BOITE • KARTON			PALLET • PALLETS • PALETTS • PALETTE		
	<i>pz</i>	<i>mq</i>	<i>kg</i>	<i>box</i>	<i>mq</i>	<i>kg</i>
<b>120x120</b>	2	2,88	21,80	24	69,12	1.039,00
<b>60x120</b>	2	1,44	32,50	30	43,20	1.000,00
<b>60x60</b>	3	1,08	23,60	40	43,26	965,00
<b>30x120</b>	3	1,08	24,20	42	45,36	1.040,00
<b>30x60</b>	6	1,08	23,90	40	43,20	980,00
<b>10x60</b>	12	0,72	16,00	60	43,20	985,00
<b>10x30</b>	20	0,60	13,00	60	36,00	800,00
<b>5x20</b>	56	0,56	11,70	60	33,60	730,00

	CASSA • CRATE • CAISSE • HOLZKISTE			CAVALLETTO • A-FRAME • CHEVALET • TRANSPORTGESTELL					
	<i>pz</i>	<i>mq</i>	<i>kg</i>	<i>pz</i>	<i>mq</i>	<i>kg</i>			
<b>120x280</b>	1	3,36	47,04	20	67,20	1.090,00	44	147,84	2.220,00

Pezzi speciali • Special trims • Pièces spéciales • Formstücke

## Battiscopa



13,30 kg



**290772**  
PLATFORM POWDER  
BATTISCOPA 5x30  
Cod. **116** △

**290773**  
PLATFORM SAGE  
BATTISCOPA 5x30  
Cod. **116** △

**290770**  
PLATFORM BLUE  
BATTISCOPA 5x30  
Cod. **116** △

**290771**  
PLATFORM BRONZE  
BATTISCOPA 5x30  
Cod. **116** △



13,40 kg

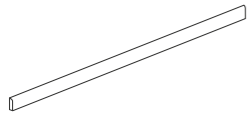

**290776**  
PLATFORM POWDER  
BATTISCOPA 5x60  
Cod. **121** △

**290777**  
PLATFORM SAGE  
BATTISCOPA 5x60  
Cod. **121** △

**290774**  
PLATFORM BLUE  
BATTISCOPA 5x60  
Cod. **121** △

**290775**  
PLATFORM BRONZE  
BATTISCOPA 5x60  
Cod. **121** △



12,00 kg

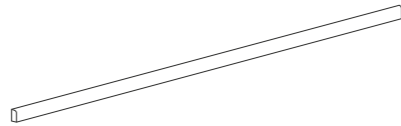

**290780**  
PLATFORM POWDER  
BATTISCOPA 5x120  
Cod. **33** △

**290781**  
PLATFORM SAGE  
BATTISCOPA 5x120  
Cod. **33** △

**290778**  
PLATFORM BLUE  
BATTISCOPA 5x120  
Cod. **33** △

**290779**  
PLATFORM BRONZE  
BATTISCOPA 5x120  
Cod. **33** △

## Gradino



29,40 kg

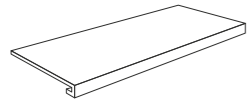

**490697**  
PLATFORM POWDER  
GRADINO 33x60  
Cod. **112** ○

**490698**  
PLATFORM SAGE  
GRADINO 33x60  
Cod. **112** ○

**490695**  
PLATFORM BLUE  
GRADINO 33x60  
Cod. **112** ○

**490696**  
PLATFORM BRONZE  
GRADINO 33x60  
Cod. **112** ○

## Angolare



10,00 kg

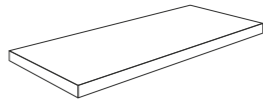

**490701**  
PLATFORM POWDER  
ANGOLARE 33x60  
Cod. **107** ○

**490702**  
PLATFORM SAGE  
ANGOLARE 33x60  
Cod. **107** ○

**490699**  
PLATFORM BLUE  
ANGOLARE 33x60  
Cod. **107** ○

**490700**  
PLATFORM BRONZE  
ANGOLARE 33x60  
Cod. **107** ○

## Gradino



17,30 kg

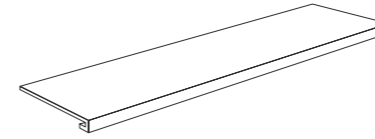

**490705**  
PLATFORM POWDER  
GRADINO 33x120  
Cod. **114** ○

**490706**  
PLATFORM SAGE  
GRADINO 33x120  
Cod. **114** ○

**490703**  
PLATFORM BLUE  
GRADINO 33x120  
Cod. **114** ○

**490704**  
PLATFORM BRONZE  
GRADINO 33x120  
Cod. **114** ○

## Angolare



20,00 kg

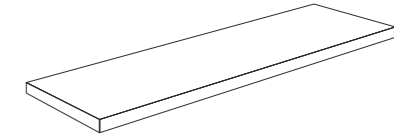

**490709**  
PLATFORM POWDER  
ANGOLARE 33x120  
Cod. **110** ○

**490710**  
PLATFORM SAGE  
ANGOLARE 33x120  
Cod. **110** ○

**490707**  
PLATFORM BLUE  
ANGOLARE 33x120  
Cod. **110** ○

**490708**  
PLATFORM BRONZE  
ANGOLARE 33x120  
Cod. **110** ○

	CARATTERISTICHE DI QUALITÀ Quality characteristics Caractéristiques de qualité Qualitätseigenschaften	NORMA Norm Norme Norme	REQUISITO NORMA Required standards Valeur prescrite selon la norme Normvorgabe	RISULTATO Result Résultat Ergebniss
	Assorbimento d'acqua Water absorption of the body Absorption d'eau de support Wasseraufnahme des Scherbens	ISO 10545-3	≤ 0,5	Conforme Conformity Conforme Gemäss
	Resistenza a flessione Breaking strenght Résistance à la flexion Biegefestigkeit	ISO 10545-4	≥ 35 N/mm <sup>2</sup>	Conforme Conformity Conforme Gemäss
	Resistenza all'abrasione Abrasion resistance Resistance a l'abrasion Abriebbestaendigkeit	EN ISO 10545-7	Powder Blue - Bronze - Sage	PEI V PEI IV
	Resistenza al gelo Frost resistance Résistance au gel Frostbeständigkeit	ISO 10545-12	Nessun campione deve presentare rotture o alterazioni apprezzabili alla superficie No samples must show ruptures or noticeable surface alteration Aucuns enchantions doit présenter ruptures ou altérations appréciables de la surface Keines der Muster sollte Risse oder sichtbare Fehler der Oberfläche zeigen	Conforme Conformity Conforme Gemäss
	Resistenza all'attacco chimico Chemical resistance Résistance à l'attaque chimique Beständigkeit gegen chemikalien	ISO 10545-13		GA GLA
	Resistenza agli sbalzi termici Thermal shock resistance Resistance aux ecarts de température Temperaturwechselbeständigkeit	ISO 10545-5		Conforme Conformity Conforme Gemäss
	Resistenza scivolosità Sliding resistance Resistance au glissement Rutschfestigkeit	DIN 51130 R		R10
	Coefficiente d'attrito dinamico Wet dynamic coefficient of friction Coefficient de friction dynamique Reibungskoeffizient Schlüpfigkeit (in Bewegung)	Bot 3000 E	DCOF ≥ 0,42	> 0,42
	Significativa variazione Significant variation Variation important Bedeutsam Abweichung			V3

Aspetto uniforme  
Uniform appearance  
Aspect uniforme  
Einheitliches Aussehen

Lieve variazione  
Slight variation  
Légère variation  
Geringe Abweichung

Significativa variazione  
Significant variation  
Variation important  
Bedeutsam Abweichung

Forte stonalizzazione  
Substantial variation  
Effet dénuancé très accentué  
Akzentuierte Variation

**PER UNA POSA OTTIMALE DEL PRODOTTO CONSIGLIAMO SEMPRE DI MESCOLARE ALMENO TRE SCATOLE DI MATERIALE.**

For the best product laying results, material from at least three boxes should be mixed.

Pour une pose excellente, nous recommandons toujours de mélanger le contenu d'au moins trois boîtes.

Für eine optimale Verlegung des Erzeugnisses empfehlen wir stets, mindestens drei Packungen Material anzumischen.



Tipologia  
Type  
Typologie  
Typ  
Gres porcellanato smaltato  
Glazed porcelain  
Grès cérame emaille  
Feinsteinzeug glasiert

Formati  
Sizes  
Formats  
Formate  
60x120  
60x60  
30x60  
10x30

Spessore  
Thickness  
Épaisseur  
Stärke  
9 mm

Resistenza scivolosità  
Sliding resistance  
Resistance au glissement  
Rutschfestigkeit  
R9

Grado di variazione cromatica  
Degree of colour change  
Degré de variation chromatique  
Grad der Farbabweichung  
V3



**0601325**  
POSITANO BLUE  
RETTIFICATO 60x120  
Cod. **94** □

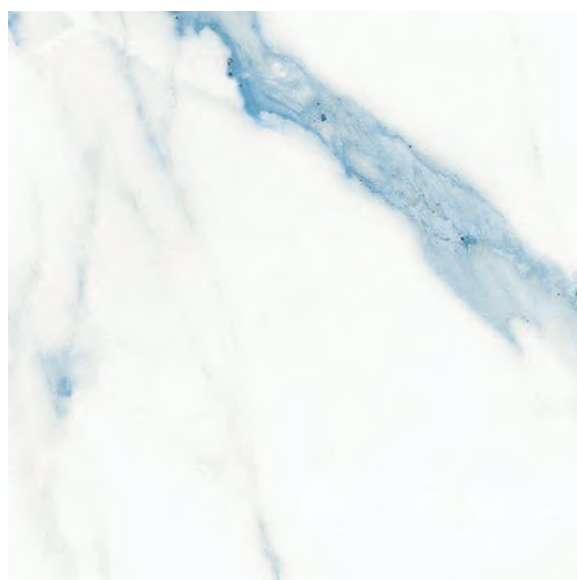

**0606271**  
POSITANO BLUE  
RETTIFICATO 60x60  
Cod. **87** □



**0490822**  
POSITANO BLUE  
RETTIFICATO 30x60  
Cod. **79** □



**0103152**  
POSITANO BLUE  
RETTIFICATO 10x30  
Cod. **87** □

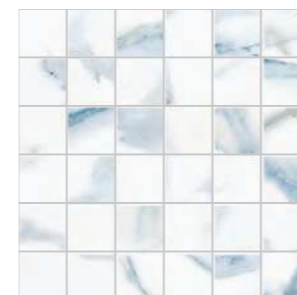

6  
9,70 kg

**0041424**  
POSITANO BLUE  
MOSAICO 5x5 SU RETE 30x30  
Cod. **26** ○



6  
8,90 kg

**0041432**  
POSITANO BLUE  
MOSAICO ESAGONO SU RETE 27x28  
Cod. **45** ○



6  
9,80 kg

**0041440**  
POSITANO BLUE  
MOSAICO HB SU RETE 28x32  
Cod. **46** ○



6  
9,80 kg

**0041449**  
POSITANO BLUE  
MOSAICO ANTIQUE LUX SU RETE 30x30  
Cod. **69** ○

IMBALLI • PACKAGES • EMBALLAGES • FORMATE

	SCATOLA • BOX • BOITE • KARTON			PALLET • PALLETS • PALETTS • PALETTE		
	<i>pz</i>	<i>mq</i>	<i>kg</i>	<i>box</i>	<i>mq</i>	<i>kg</i>
<b>60x120</b>	2	1,44	28,70	30	43,20	861,00
<b>60x60</b>	3	1,08	21,50	40	43,20	861,00
<b>30x60</b>	6	1,08	21,50	40	43,20	861,00
<b>10x30</b>	20	0,60	11,40	60	36,00	684,00





Pezzi speciali • Special trims • Pièces spéciales • Formstücke

Battiscopa

44  
17,20 kg

18  
14,80 kg

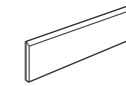

**0290840**  
POSITANO BLUE  
BATTISCOPA 7x30  
Cod. **19** △

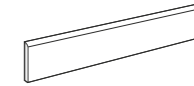

**0290848**  
POSITANO BLUE  
BATTISCOPA 7x60  
Cod. **23** △

CARATTERISTICHE DI QUALITÀ Quality characteristics Caractéristiques de qualité Qualitätseigenschaften	NORMA Norm Norme Norme	REQUISITO NORMA Required standards Valeur prescrite selon la norme Normvorgabe	RISULTATO Result Résultat Ergebnis
Assorbimento d'acqua Water absorption of the body Absorption d'eau de support Wasseraufnahme des Scherbens	ISO 10545-3	≤ 0,5	Conforme Conformity Conforme Gemäss
Resistenza a flessione Breaking strenght Résistance à la flexion Biegefestigkeit	ISO 10545-4	≥ 35 N/mm <sup>2</sup>	Conforme Conformity Conforme Gemäss
Resistenza all'abrasione Abrasion resistance Résistance à l'abrasion Abriebbeständigkeit	ISO 10545-7		PEI IV
Resistenza al gelo Frost resistance Résistance au gel Frostbeständigkeit	ISO 10545-12	Nessun campione deve presentare rotture o alterazioni apprezzabili alla superficie No samples must show ruptures or noticeable surface alteration Aucuns enchantions doit présenter ruptures ou altérations appréciables de la surface Keines der Muster sollte Risse oder sichtbare Fehler der Oberfläche zeigen	Conforme Conformity Conforme Gemäss
Resistenza all'attacco chimico Chemical resistance Résistance à l'attaque chimique Beständigkeit gegen chemikalien	ISO 10545-13		GA GLA
Resistenza agli sbalzi termici Thermal shock resistance Résistance aux écarts de température Temperaturwechselbeständigkeit	ISO 10545-5		Conforme Conformity Conforme Gemäss
Resistenza scivolosità Sliding resistance Résistance au glissement Rutschfestigkeit	DIN 51130 R		R9
Coefficiente d'attrito dinamico Wet dynamic coefficient of friction Coefficient de friction dynamique Reibungskoeffizient Schlupfrigkeit (in Bewegung)	Bot 3000 E	DCOF ≥ 0,42	> 0,42
Significativa variazione Significant variation Variation important Bedeutsam Abweichung			V3

**V1**  
Aspetto uniforme  
Uniform appearance  
Aspect uniforme  
Einheitliches Aussehen

**V2**  
Lieve variazione  
Slight variation  
Légère variation  
Geringe Abweichung

**V3**  
Significativa variazione  
Significant variation  
Variation important  
Bedeutsam Abweichung

**V4**  
Forte stonalizzazione  
Substantial variation  
Effet dénuancé très accentué  
Akzentuierte Variation

**PER UNA POSA OTTIMALE DEL PRODOTTO CONSIGLIAMO SEMPRE DI MESCOLARE ALMENO TRE SCATOLE DI MATERIALE.**

For the best product laying results, material from at least three boxes should be mixed.

Pour une pose excellente, nous recommandons toujours de mélanger le contenu d'au moins trois boîtes.

Für eine optimale Verlegung des Erzeugnisses empfehlen wir stets, mindestens drei Packungen Material anzumischen.



Tipologia  
Type  
Typologie  
Typ  
Gres porcellanato smaltato  
Glazed porcelain  
Grès cérame émaille  
Feinsteinzeug glasiert

Formati  
Sizes  
Formats  
Formate  
60x120  
60x60  
30x60  
30x30  
10x30

Spessore  
Thickness  
Épaisseur  
Stärke  
9 mm

Resistenza scivolosità  
Sliding resistance  
Resistance au glissement  
Rutschfestigkeit  
R9

Grado di variazione cromatica  
Degree of colour change  
Degré de variation chromatique  
Grad der Farbabweichung  
V3

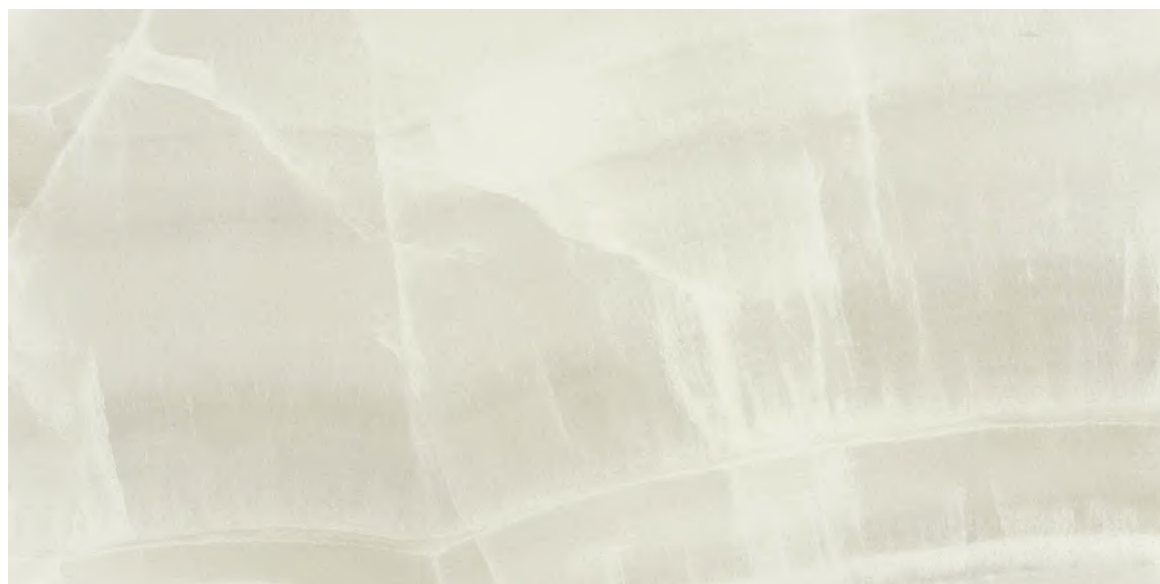

**601266**  
PREMIUM ONYX NATURALE  
RETTIFICATO 60x120  
Cod. **94** □

**601267**  
PREMIUM ONYX LAPPATO  
RETTIFICATO 60x120  
Cod. **103** □



**606202**  
PREMIUM ONYX NATURALE  
RETTIFICATO 60x60  
Cod. **79** □

**606204**  
PREMIUM ONYX LAPPATO  
RETTIFICATO 60x60  
Cod. **93** □

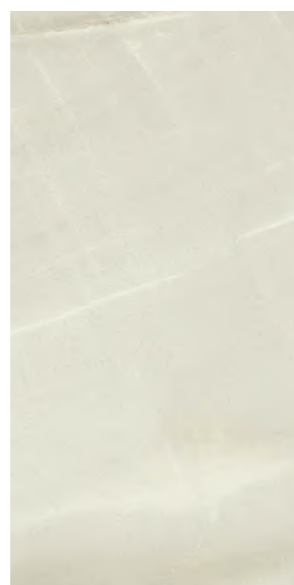

**490560**  
PREMIUM ONYX NATURALE  
RETTIFICATO 30x60  
Cod. **76** □

**490562**  
PREMIUM ONYX LAPPATO  
RETTIFICATO 30x60  
Cod. **85** □



**040919**  
PREMIUM ONYX NATURALE RETTIFICATO 30x30  
Cod. **78** □

**040923**  
PREMIUM ONYX LAPPATO RETTIFICATO 30x30  
Cod. **90** □



**103103**  
PREMIUM ONYX NATURALE  
RETTIFICATO 10x30  
Cod. **77** □

**103106**  
PREMIUM ONYX LAPPATO  
RETTIFICATO 10x30  
Cod. **111** □



6  
9,30 kg

**040920**  
PREMIUM ONYX NATURALE  
MOSAICO 5x5 SU RETE 30x30  
Cod. **24** ○

**040924**  
PREMIUM ONYX LAPPATO  
MOSAICO 5x5 SU RETE 30x30  
Cod. **31** ○



6  
9,30 kg

**041137**  
PREMIUM ONYX NATURALE MOSAICO  
INTARSIO SU RETE 30x30  
Cod. **31** ○

**041138**  
PREMIUM ONYX LAPPATO MOSAICO  
INTARSIO SU RETE 30x30  
Cod. **35** ○



6  
10,20 kg

**041125**  
PREMIUM ONYX NATURALE  
MOSAICO HB SU RETE 28x32  
Cod. **45** ○

**041136**  
PREMIUM ONYX LAPPATO  
MOSAICO HB SU RETE 28x32  
Cod. **48** ○

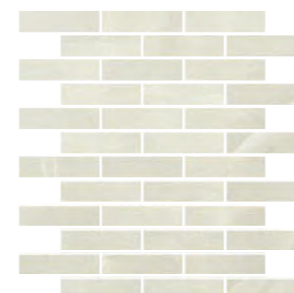

6  
9,30 kg

**041128**  
PREMIUM ONYX NATURALE  
MURETTO 2,4x10 SU RETE 30x30  
Cod. **46** ○

**041139**  
PREMIUM ONYX LAPPATO  
MURETTO 2,4x10 SU RETE 30x30  
Cod. **58** ○



6  
8,90 kg

**040921**  
PREMIUM ONYX NATURALE  
MOSAICO ESAGONO SU RETE 27x28  
Cod. **136** ○

**041135**  
PREMIUM ONYX LAPPATO  
MOSAICO ESAGONO SU RETE 27x28  
Cod. **49** ○



6  
10,30 kg

**041173**  
PREMIUM ONYX NATURALE  
MOSAICO ARABESQUE SU RETE 30x30  
Cod. **57** ○

**041174**  
PREMIUM ONYX LAPPATO  
MOSAICO ARABESQUE SU RETE 30x30  
Cod. **72** ○



**380268**  
PREMIUM ONYX NATURALE  
LONDON 5x30  
Cod. **33** ○

12  
3,22 kg

**380269**  
PREMIUM ONYX LUCIDO  
LONDON 5x30  
Cod. **33** ○

IMBALLI • PACKAGES • EMBALLAGES • FORMATE

	SCATOLA • BOX • BOITE • KARTON			PALLET • PALLETS • PALETTS • PALETTE		
	pz	mq	kg	box	mq	kg
<b>60x120</b>	2	1,44	30,20	30	43,20	906,00
<b>60x60</b>	3	1,08	22,60	40	43,20	904,00
<b>30x60</b>	6	1,08	22,60	40	43,20	904,00
<b>30x30</b>	11	0,99	21,12	46	45,54	975,00
<b>10x30</b>	20	0,60	12,90	60	36,00	774,00



## premium onyx RETT. LAPPATO

La finitura lappata è consigliata per uso rivestimento o per pavimenti da bagno in ambito residenziale. Nello specifico il tipo di pavimentazione deve essere non soggetta ad eccessive sollecitazioni e mai a diretto contatto con aree esterne. Come si verifica comunemente nelle pietre naturali l'eventuale presenza di puntini sulla superficie o di qualche disuniformità della lucentezza sono da considerare caratteristiche del prodotto derivanti dalla lavorazione a cui viene sottoposto.

The polished finish is recommended for wall coverings or for the floors of residential bathrooms. Specifically, floor coverings in this material must not be subjected to excessively heavy traffic and must never be in direct contact with outdoor areas. As is often the case with natural stones, any spots on the surface or any unevenness in shine are typical characteristics of the product, deriving from the process used.

La finition polie est recommandée pour le revêtement sol et mur des salles de bains résidentielles. Notamment, ce type de carreau au sol ne doit pas être exposé à des contraintes excessives, et il ne doit jamais être en contact direct avec des zones extérieures. Comme cela est souvent le cas pour les pierres naturelles, les micro trous éventuellement présents à la surface du produit ou l'hétérogénéité de son éclat forment des caractéristiques propres au façonnage.

Die polierte Oberfläche wird für Wandverkleidungen und Bodenbeläge in Privatbädern empfohlen. Der Bodenbelag darf keinen starken Beanspruchungen ausgesetzt sein und keinen direkten Kontakt zu Außenbereichen haben. Wie bei Natursteinen üblich, kann die Oberfläche Körnungen oder einen unregelmäßigen Glanz aufweisen. Diese Merkmale sind typische, beabsichtigte Produkteigenschaften, die durch das Bearbeitungsverfahren hervorgerufen werden.

Pezzi speciali • Special trims • Pièces spéciales • Formstücke

Battiscopa



**290711**  
PREMIUM ONYX NATURALE  
BATTISCOPA 7x30  
Cod. **116** △

**290712**  
PREMIUM ONYX LAPPATO  
BATTISCOPA 7x30  
Cod. **22** △



**290743**  
PREMIUM ONYX NATURALE  
BATTISCOPA 7x60  
Cod. **121** △

**290744**  
PREMIUM ONYX LAPPATO  
BATTISCOPA 7x60  
Cod. **26** △

CARATTERISTICHE DI QUALITÀ Quality characteristics Caractéristiques de qualité Qualitätseigenschaften	NORMA Norm Norme Norme	REQUISITO NORMA Required standards Valeur prescrite selon la norme Normvorgabe	RISULTATO Result Résultat Ergebniss
Assorbimento d'acqua Water absorption of the body Absorption d'eau de support Wasseraufnahme des Scherbens	ISO 10545-3	≤ 0,5	Conforme Conformity Conforme Gemäss
Resistenza a flessione Breaking strenght Résistance à la flexion Biegefestigkeit	ISO 10545-4	≥ 35 N/mm <sup>2</sup>	Conforme Conformity Conforme Gemäss
Resistenza all'abrasione Abrasion resistance Résistance à l'abrasion Abriebbeständigkeit	ISO 10545-7	Premium Onyx Rettificato  Premium Onyx Lappato	PEI IV
Resistenza al gelo Frost resistance Résistance au gel Frostbeständigkeit	ISO 10545-12	Nessun campione deve presentare rotture o alterazioni apprezzabili alla superficie No samples must show ruptures or noticeable surface alteration Aucuns enchanions doit présenter ruptures ou altérations appréciables de la surface Keines der Muster sollte Risse oder sichtbare Fehler der Oberfläche zeigen	Conforme Conformity Conforme Gemäss
Resistenza all'attacco chimico Chemical resistance Résistance à l'attaque chimique Beständigkeit gegen chemikalien	ISO 10545-13	Premium Onyx Rettificato  Premium Onyx Lappato	GA GLA  GA GLB
Resistenza agli sbalzi termici Thermal shock resistance Résistance aux écarts de température Temperaturwechselbeständigkeit	ISO 10545-5		Conforme Conformity Conforme Gemäss
Resistenza scivolosità Sliding resistance Résistance au glissement Rutschfestigkeit	DIN 51130 R	Premium Onyx Rettificato  Premium Onyx Lappato	R9
Significativa variazione Significant variation Variation important Bedeutsam Abweichung			V3

**V1**  
Aspetto uniforme  
Uniform appearance  
Aspect uniforme  
Einheitliches Aussehen

**V2**  
Lieve variazione  
Slight variation  
Légère variation  
Geringe Abweichung

**V3**  
Significativa variazione  
Significant variation  
Variation important  
Bedeutsam Abweichung

**V4**  
Forte stonalizzazione  
Substantial variation  
Effet dénuancé très accentué  
Akzentuierte Variation

**PER UNA POSA OTTIMALE DEL PRODOTTO CONSIGLIAMO SEMPRE DI MESCOLARE ALMENO TRE SCATOLE DI MATERIALE.**

For the best product laying results, material from at least three boxes should be mixed.

Pour une pose excellente, nous recommandons toujours de mélanger le contenu d'au moins trois boîtes.

Für eine optimale Verlegung des Erzeugnisses empfehlen wir stets, mindestens drei Packungen Material anzumischen.



Tipologia  
Type  
Typologie  
Typ  
Gres porcellanato smaltato  
Glazed porcelain  
Grès cérame emaille  
Feinsteinzeug glasiert

Formati  
Sizes  
Formats  
Formate  
60x120  
60x60  
30,5x60,5  
30x60  
15x61  
15x60  
10x30  
7,5x60  
5x60

Spessore  
Thickness  
Épaisseur  
Stärke  
10 mm  
20mm

Formati R11  
60x60 (20mm)  
60x120 (20mm)

Resistenza scivolosità  
Sliding resistance  
Resistance au glissement  
Rutschfestigkeit  
R10 / A+B  
R11 / A+B+C (20mm.)

Grado di variazione cromatica  
Degree of colour change  
Degré de variation chromatique  
Grad der Farbabweichung  
V2



**601315**  
QUARZ ANTRACITE  
RETTIFICATO 60x120  
Cod. **94** □

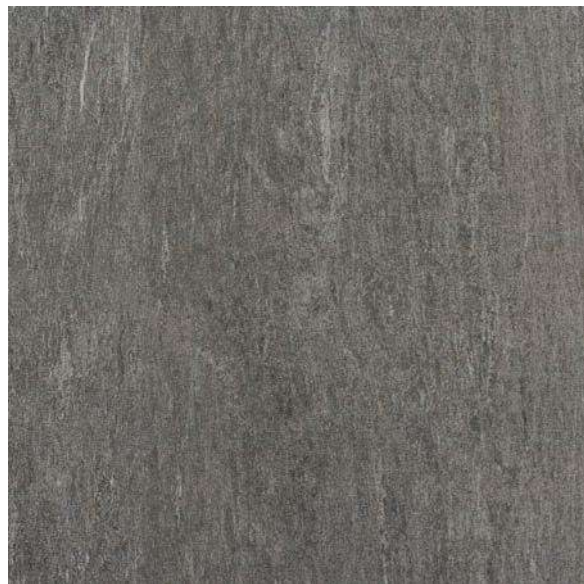

**606209**  
QUARZ ANTRACITE  
RETTIFICATO 60x60  
Cod. **77** □



**490592**  
QUARZ ANTRACITE  
NATURALE 30,5x60,5  
Cod. **66** □



**490588**  
QUARZ ANTRACITE  
RETTIFICATO 30x60  
Cod. **75** □

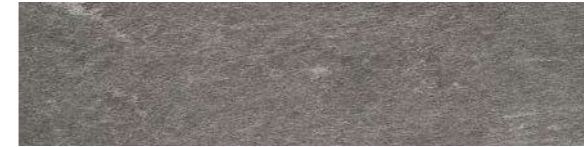

**550114**  
QUARZ ANTRACITE  
RETTIFICATO 15x60  
Cod. **79** □



**103094**  
QUARZ ANTRACITE  
RETTIFICATO 10x30  
Cod. **120** □



**700013**  
QUARZ ANTRACITE  
RETTIFICATO 7,5x60  
Cod. **85** □



**506002**  
QUARZ ANTRACITE  
RETTIFICATO 5x60  
Cod. **90** □

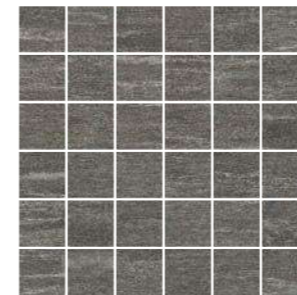

**041101**  
QUARZ ANTRACITE  
MOSAICO 5x5 SU RETE 30x30  
Cod. **24** ○  11,46 kg



**150612**  
QUARZ GREY/ANTRACITE 3D NATURALE 15x61  
Cod. **75** □

IMBALLI • PACKAGES • EMBALLAGES • FORMATE

	SCATOLA • BOX • BOITE • KARTON			PALLET • PALLETS • PALETTS • PALETTE		
	<i>pz</i>	<i>mq</i>	<i>kg</i>	<i>box</i>	<i>mq</i>	<i>kg</i>
<b>60x120</b>	2	1,44	30,00	32	46,08	960,00
<b>60x60</b>	3	1,08	21,40	40	43,20	856,00
<b>30,5x60,5</b>	6	1,11	22,50	40	44,40	900,00
<b>30x60</b>	6	1,08	21,50	40	43,20	860,00
<b>3D 15x61</b>	11	1,02	18,10	48	48,96	869,00
<b>15x60</b>	10	0,90	17,40	48	43,20	835,00
<b>7,5x60</b>	18	0,81	14,50	64	51,84	928,00
<b>5x60</b>	24	0,72	12,70	60	43,20	762,00
<b>10x30</b>	20	0,60	11,60	60	36,00	696,00



**601316**  
QUARZ BEIGE  
RETTIFICATO 60x120  
Cod. **94** □



**606210**  
QUARZ BEIGE  
RETTIFICATO 60x60  
Cod. **77** □

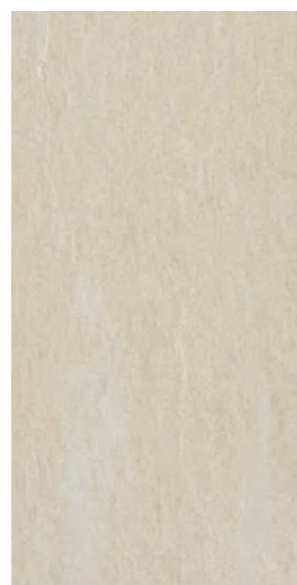

**490593**  
QUARZ BEIGE  
NATURALE 30,5x60,5  
Cod. **66** □

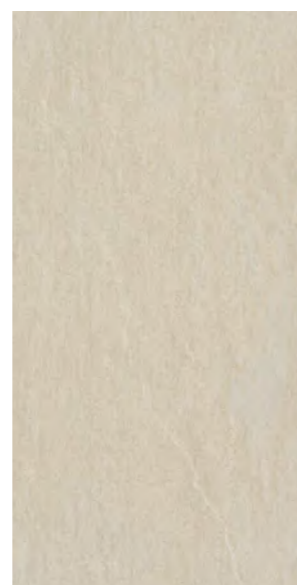

**490589**  
QUARZ BEIGE  
RETTIFICATO 30x60  
Cod. **75** □



**550115**  
QUARZ BEIGE  
RETTIFICATO 15x60  
Cod. **79** □

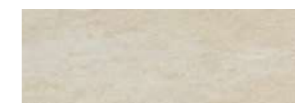

**103095**  
QUARZ BEIGE  
RETTIFICATO 10x30  
Cod. **120** □



**700014**  
QUARZ BEIGE  
RETTIFICATO 7,5x60  
Cod. **85** □



**506003**  
QUARZ BEIGE  
RETTIFICATO 5x60  
Cod. **90** □



**041102**  
QUARZ BEIGE  
MOSAICO 5x5 SU RETE 30x30  
Cod. **24** ○



11,46 kg



**150611**  
QUARZ BEIGE/TAUPE 3D NATURALE 15x61  
Cod. **75** □

**IMBALLI • PACKAGES • EMBALLAGES • FORMATE**

	SCATOLA • BOX • BOITE • KARTON			PALLET • PALLETS • PALETTS • PALETTE		
	<i>pz</i>	<i>mq</i>	<i>kg</i>	<i>box</i>	<i>mq</i>	<i>kg</i>
<b>60x120</b>	2	1,44	30,00	32	46,08	960,00
<b>60x60</b>	3	1,08	21,40	40	43,20	856,00
<b>30,5x60,5</b>	6	1,11	22,50	40	44,40	900,00
<b>30x60</b>	6	1,08	21,50	40	43,20	860,00
<b>3D 15x61</b>	11	1,02	18,10	48	48,96	869,00
<b>15x60</b>	10	0,90	17,40	48	43,20	835,00
<b>7,5x60</b>	18	0,81	14,50	64	51,84	928,00
<b>5x60</b>	24	0,72	12,70	60	43,20	762,00
<b>10x30</b>	20	0,60	11,60	60	36,00	696,00



**601327**  
QUARZ GREEN  
RETTIFICATO 60x120  
Cod. **94** □



**606273**  
QUARZ GREEN  
RETTIFICATO 60x60  
Cod. **77** □



**490849**  
QUARZ GREEN  
RETTIFICATO 30x60  
Cod. **75** □



**550124**  
QUARZ GREEN  
RETTIFICATO 15x60  
Cod. **79** □



**103159**  
QUARZ GREEN  
RETTIFICATO 10x30  
Cod. **120** □



**700020**  
QUARZ GREEN  
RETTIFICATO 7,5x60  
Cod. **85** □



**506009**  
QUARZ GREEN  
RETTIFICATO 5x60  
Cod. **90** □



**041463**  
QUARZ GREEN  
MOSAICO 5x5 SU RETE 30x30  
Cod. **24** ○



11,46 kg

IMBALLI • PACKAGES • EMBALLAGES • FORMATE

	SCATOLA • BOX • BOITE • KARTON			PALLET • PALLETS • PALETTS • PALETTE		
	<i>pz</i>	<i>mq</i>	<i>kg</i>	<i>box</i>	<i>mq</i>	<i>kg</i>
<b>60x120</b>	2	1,44	30,00	32	46,08	960,00
<b>60x60</b>	3	1,08	21,40	40	43,20	856,00
<b>30,5x60,5</b>	6	1,11	22,50	40	44,40	900,00
<b>30x60</b>	6	1,08	21,50	40	43,20	860,00
<b>3D 15x61</b>	11	1,02	18,10	48	48,96	869,00
<b>15x60</b>	10	0,90	17,40	48	43,20	835,00
<b>7,5x60</b>	18	0,81	14,50	64	51,84	928,00
<b>5x60</b>	24	0,72	12,70	60	43,20	762,00
<b>10x30</b>	20	0,60	11,60	60	36,00	696,00





**601317**  
QUARZ GREY  
RETTIFICATO 60x120  
Cod. **94** □



**606211**  
QUARZ GREY  
RETTIFICATO 60x60  
Cod. **77** □



**490594**  
QUARZ GREY  
NATURALE 30,5x60,5  
Cod. **66** □



**490590**  
QUARZ GREY  
RETTIFICATO 30x60  
Cod. **75** □



**550116**  
QUARZ GREY  
RETTIFICATO 15x60  
Cod. **79** □



**103096**  
QUARZ GREY  
RETTIFICATO 10x30  
Cod. **120** □



**700012**  
QUARZ GREY  
RETTIFICATO 7,5x60  
Cod. **85** □



**506001**  
QUARZ GREY  
RETTIFICATO 5x60  
Cod. **90** □



**041103**  
QUARZ GREY  
MOSAICO 5x5 SU RETE 30x30  
Cod. **24** ○  11,46 kg



**150612**  
QUARZ GREY/ANTRACITE 3D NATURALE 15x61  
Cod. **75** □

IMBALLI • PACKAGES • EMBALLAGES • FORMATE

	SCATOLA • BOX • BOITE • KARTON			PALLET • PALLETS • PALETTS • PALETTE		
	pz	m <sup>q</sup>	kg	box	m <sup>q</sup>	kg
<b>60x120</b>	2	1,44	30,00	32	46,08	960,00
<b>60x60</b>	3	1,08	21,40	40	43,20	856,00
<b>30,5x60,5</b>	6	1,11	22,50	40	44,40	900,00
<b>30x60</b>	6	1,08	21,50	40	43,20	860,00
<b>3D 15x61</b>	11	1,02	18,10	48	48,96	869,00
<b>15x60</b>	10	0,90	17,40	48	43,20	835,00
<b>7,5x60</b>	18	0,81	14,50	64	51,84	928,00
<b>5x60</b>	24	0,72	12,70	60	43,20	762,00
<b>10x30</b>	20	0,60	11,60	60	36,00	696,00



**601318**  
QUARZ TAUPE  
RETTIFICATO 60x120  
Cod. **94** □



**606212**  
QUARZ TAUPE  
RETTIFICATO 60x60  
Cod. **77** □



**490595**  
QUARZ TAUPE  
NATURALE 30,5x60,5  
Cod. **66** □



**490591**  
QUARZ TAUPE  
RETTIFICATO 30x60  
Cod. **75** □



**550117**  
QUARZ TAUPE  
RETTIFICATO 15x60  
Cod. **79** □



**103097**  
QUARZ TAUPE  
RETTIFICATO 10x30  
Cod. **120** □



**700015**  
QUARZ TAUPE  
RETTIFICATO 7,5x60  
Cod. **85** □



**506004**  
QUARZ TAUPE  
RETTIFICATO 5x60  
Cod. **90** □

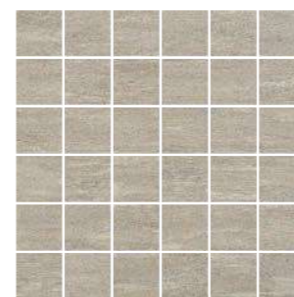

**041104**  
QUARZ TAUPE  
MOSAICO 5x5 SU RETE 30x30  
Cod. **24** ○  11,46 kg



**150611**  
QUARZ BEIGE/TAUPE 3D NATURALE 15x61  
Cod. **75** □

**IMBALLI • PACKAGES • EMBALLAGES • FORMATE**

	SCATOLA • BOX • BOITE • KARTON			PALLET • PALLETS • PALETTS • PALETTE		
	<i>pz</i>	<i>mq</i>	<i>kg</i>	<i>box</i>	<i>mq</i>	<i>kg</i>
<b>60x120</b>	2	1,44	30,00	32	46,08	960,00
<b>60x60</b>	3	1,08	21,40	40	43,20	856,00
<b>30,5x60,5</b>	6	1,11	22,50	40	44,40	900,00
<b>30x60</b>	6	1,08	21,50	40	43,20	860,00
<b>3D 15x61</b>	11	1,02	18,10	48	48,96	869,00
<b>15x60</b>	10	0,90	17,40	48	43,20	835,00
<b>7,5x60</b>	18	0,81	14,50	64	51,84	928,00
<b>5x60</b>	24	0,72	12,70	60	43,20	762,00
<b>10x30</b>	20	0,60	11,60	60	36,00	696,00



**606193**  
QUARZ ANTRACITE 2 CM RETTIFICATO 60x60  
Cod. **94** □



**601357**  
QUARZ ANTRACITE 2 CM RETTIFICATO 60x120  
Cod. **141** □



**606194**  
QUARZ BEIGE 2 CM RETTIFICATO 60x60  
Cod. **94** □



**601358**  
QUARZ BEIGE 2 CM RETTIFICATO 60x120  
Cod. **141** □



**606292**  
QUARZ GREEN 2 CM RETTIFICATO 60x60  
Cod. **94** □



**601361**  
QUARZ GREEN 2 CM RETTIFICATO 60x120  
Cod. **141** □



**606195**  
QUARZ GREY 2 CM RETTIFICATO 60x60  
Cod. **94** □



**601359**  
QUARZ GREY 2 CM RETTIFICATO 60x120  
Cod. **141** □



**606196**  
QUARZ TAUPE 2 CM RETTIFICATO 60x60  
Cod. **94** □



**601360**  
QUARZ TAUPE 2 CM RETTIFICATO 60x120  
Cod. **141** □

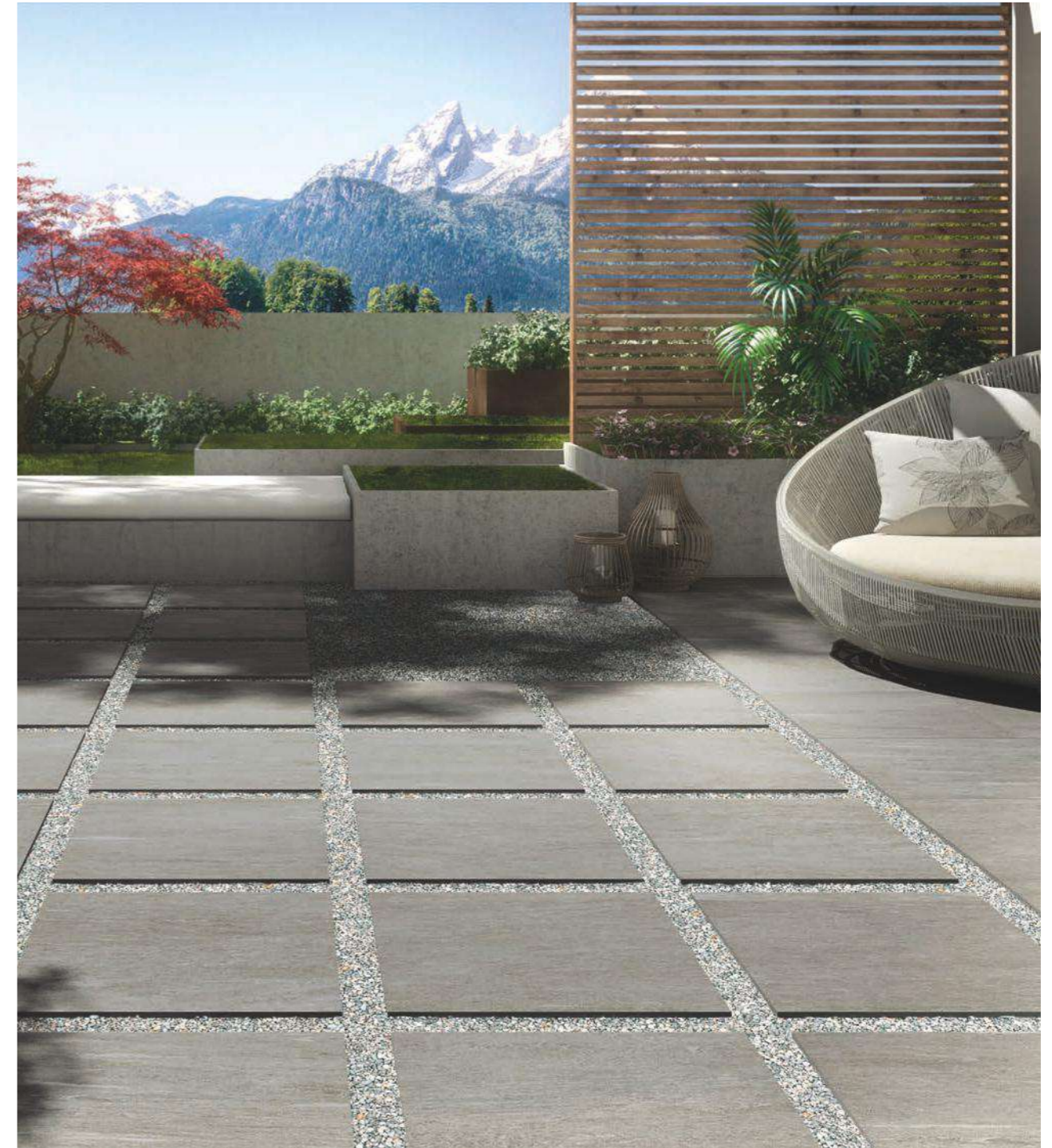







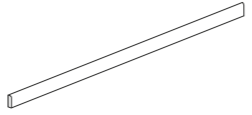



IMBALLI • PACKAGES • EMBALLAGES • FORMATE

	SCATOLA • BOX • BOITE • KARTON			PALLET • PALLETS • PALETTS • PALETTE		
	pz	mq	kg	box	mq	kg
<b>60x120 (20mm)</b>	1	0,72	31,50	30	21,60	945,00
<b>60x60 (20mm)</b>	2	0,72	30,10	32	23,04	985,00

Pezzi speciali • Special trims • Pièces spéciales • Formstücke

Battiscopa	40 11,60 kg	20 11,60 kg
	<p><b>290697</b> QUARZ ANTRACITE RETTIFICATO BATTISCOPA 5x30 Cod. <b>116</b> △</p> <p><b>290698</b> QUARZ BEIGE RETTIFICATO BATTISCOPA 5x30 Cod. <b>116</b> △</p> <p><b>290865</b> QUARZ GREEN RETTIFICATO BATTISCOPA 5x30 Cod. <b>116</b> △</p> <p><b>290699</b> QUARZ GREY RETTIFICATO BATTISCOPA 5x30 Cod. <b>116</b> △</p> <p><b>290700</b> QUARZ TAUPE RETTIFICATO BATTISCOPA 5x30 Cod. <b>116</b> △</p>	<p></p> <p><b>290701</b> QUARZ ANTRACITE RETTIFICATO BATTISCOPA 5x60 Cod. <b>121</b> △</p> <p><b>290702</b> QUARZ BEIGE RETTIFICATO BATTISCOPA 5x60 Cod. <b>121</b> △</p> <p><b>290866</b> QUARZ GREEN RETTIFICATO BATTISCOPA 5x60 Cod. <b>121</b> △</p> <p><b>290703</b> QUARZ GREY RETTIFICATO BATTISCOPA 5x60 Cod. <b>121</b> △</p> <p><b>290704</b> QUARZ TAUPE RETTIFICATO BATTISCOPA 5x60 Cod. <b>121</b> △</p>



CARATTERISTICHE DI QUALITÀ Quality characteristics Caractéristiques de qualité Qualitätseigenschaften	NORMA Norm Norme Norme	REQUISITO NORMA Required standards Valeur prescrite selon la norme Normvorgabe	RISULTATO Result Résultat Ergebniss
 Assorbimento d'acqua Water absorption of the body Absorption d'eau de support Wasseraufnahme des Scherbens	ISO 10545-3	≤ 0,5	Conforme Conformity Conforme Gemäss
 Resistenza a flessione Breaking strenght Résistance à la flexion Biegefestigkeit	ISO 10545-4	≥ 35 N/mm <sup>2</sup>	Conforme Conformity Conforme Gemäss
 Resistenza all'abrasione Abrasion resistance Resistance a l'abrasion Abriebbestaendigkeit	ISO 10545-7		PEI V
 Resistenza al gelo Frost resistance Résistance au gel Frostbeständigkeit	ISO 10545-12	Nessun campione deve presentare rotture o alterazioni apprezzabili alla superficie No samples must show ruptures or noticeable surface alteration Aucuns enchantions doit présenter ruptures ou altérations appréciables de la surface Keines der Muster sollte Risse oder sichtbare Fehler der Oberfläche zeigen	Conforme Conformity Conforme Gemäss
 Resistenza all'attacco chimico Chemical resistance Résistance à l'attaque chimique Beständigkeit gegen chemikalien	ISO 10545-13		GA GLA
 Resistenza agli sbalzi termici Thermal shock resistance Resistance aux ecart de température Temperaturwechselbeständigkeit	ISO 10545-5		Conforme Conformity Conforme Gemäss
 Resistenza scivolosità Sliding resistance Resistance au glissement Rutschfestigkeit	DIN 51130 R	QUARZ 20 mm	R10 R11
 Resistenza scivolosità Sliding resistance Resistance au glissement Rutschfestigkeit	DIN 51097 (A+B+C)	QUARZ 20 mm	A+B A+B+C
 Coefficiente d'attrito dinamico Wet dynamic coefficient of friction Coefficient de friction dynamique Reibungskoeffizient Schlüfrigkeit (in Bewegung)	Bot 3000 E	DCOF ≥ 0,42	> 0,42
 Lieve variazione Slight variation Légère variation Geringe Abweichung			V2

 **V1**  
Aspetto uniforme  
Uniform appearance  
Aspect uniforme  
Einheitliches Aussehen

 **V2**  
Lieve variazione  
Slight variation  
Légère variation  
Geringe Abweichung

 **V3**  
Significativa variazione  
Significant variation  
Variation important  
Bedeutsam Abweichung

 **V4**  
Forte stonizzazione  
Substantial variation  
Effet dénuancé très accentué  
Akzentuierte Variation

**PER UNA POSA OTTIMALE DEL PRODOTTO CONSIGLIAMO SEMPRE DI MESCOLARE ALMENO TRE SCATOLE DI MATERIALE.**

For the best product laying results, material from at least three boxes should be mixed.

Pour une pose excellente, nous recommandons toujours de mélanger le contenu d'au moins trois boîtes.

Für eine optimale Verlegung des Erzeugnisses empfehlen wir stets, mindestens drei Packungen Material anzumischen.



Tipologia  
Type  
Typologie  
Typ  
Gres porcellanato smaltato  
Glazed porcelain  
Grès cérame emaille  
Feinsteinzeug glasiert

Formati  
Sizes  
Formats  
Formate  
30x60  
15x60  
30x30  
10x30  
15x15  
7,5x15  
10x10

Spessore  
Thickness  
Épaisseur  
Stärke  
9 mm

Resistenza scivolosità  
Sliding resistance  
Resistance au glissement  
Rutschfestigkeit  
R9

Grado di variazione cromatica  
Degree of colour change  
Degré de variation chromatique  
Grad der Farbabweichung  
V3



**490488**  
ROYAL MARBLES LIGHT BARDIGLIO RETTIFICATO 30x60  
Cod. **76** □

**490490**  
ROYAL MARBLES LIGHT BARDIGLIO LAPPATO RETTIFICATO 30x60  
Cod. **85** □

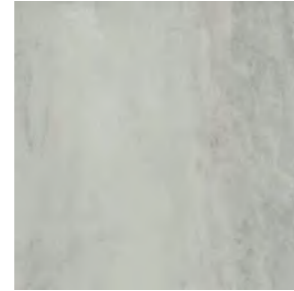

**040967**  
ROYAL MARBLES LIGHT BARDIGLIO  
RETTIFICATO 30x30 Cod. **78** □

**040968**  
ROYAL MARBLES LIGHT BARDIGLIO  
LAPPATO RETTIFICATO 30x30 Cod. **90** □

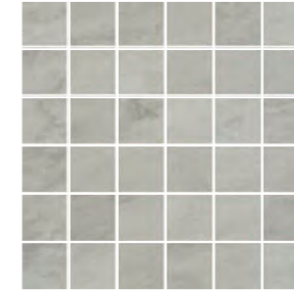

**040991**  
ROYAL MARBLES LIGHT BARDIGLIO  
MOSAICO 5x5 SU RETE 30x30  
Cod. **24** ○

**040992**  
ROYAL MARBLES LIGHT BARDIGLIO LAPPATO  
MOSAICO 5x5 SU RETE 30x30  
Cod. **31** ○



9,30 kg



**040997**  
ROYAL MARBLES LIGHT BARDIGLIO  
MURETTO 2,4x10 SU RETE 30x30  
Cod. **46** ○

**040998**  
ROYAL MARBLES LIGHT BARDIGLIO LAPPATO  
MURETTO 2,4x10 SU RETE 30x30  
Cod. **58** ○



9,30 kg



**040979**  
ROYAL MARBLES LIGHT BARDIGLIO  
MOSAICO ESAGONO SU RETE 27x28  
Cod. **136** ○

**040980**  
ROYAL MARBLES LIGHT BARDIGLIO LAPPATO  
MOSAICO ESAGONO SU RETE 27x28  
Cod. **49** ○



8,90 kg



**550103**  
ROYAL MARBLES LIGHT BARDIGLIO RETTIFICATO 15x60  
Cod. **95** □

**550104**  
ROYAL MARBLES LIGHT BARDIGLIO LAPPATO RETTIFICATO 15x60  
Cod. **111** □

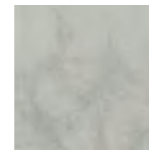

**230253**  
ROYAL MARBLES LIGHT BARDIGLIO  
RETTIFICATO 15x15 Cod. **78** □

**230254**  
ROYAL MARBLES LIGHT BARDIGLIO  
LAPPATO RETTIFICATO 15x15 Cod. **90** □



**040985**  
ROYAL MARBLES LIGHT BARDIGLIO  
MOSAICO BASKETWAVE SU RETE 30x30  
Cod. **47** ○

**040986**  
ROYAL MARBLES LIGHT BARDIGLIO LAPPATO  
MOSAICO BASKETWAVE SU RETE 30x30  
Cod. **60** ○



11,50 kg



**380224**  
ROYAL MARBLES LIGHT BARDIGLIO  
NATURALE LONDON 5x30  
Cod. **33** ○

**380225**  
ROYAL MARBLES LIGHT BARDIGLIO  
LUCIDO LONDON 5x30  
Cod. **33** ○



6,11 kg



**380230**  
ROYAL MARBLES LIGHT BARDIGLIO  
BORDURA MURETTO SU RETE 7x30  
Cod. **28** ○

**380231**  
ROYAL MARBLES LIGHT BARDIGLIO LAPPATO  
BORDURA MURETTO SU RETE 7x30  
Cod. **28** ○



3,60 kg

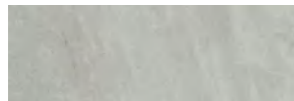

**103074**  
ROYAL MARBLES LIGHT BARDIGLIO  
RETTIFICATO 10x30 Cod. **77** □

**103075**  
ROYAL MARBLES LIGHT BARDIGLIO  
LAPPATO RETTIFICATO 10x30 Cod. **93** □



**450373**  
ROYAL MARBLES LIGHT BARDIGLIO  
RETTIFICATO (sfuso) 10x10 Cod. **90** □

**450374**  
ROYAL MARBLES LIGHT BARDIGLIO  
LAPPATO RETTIFICATO (sfuso) 10x10 Cod. **106** □

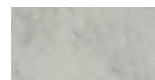

**040973**  
ROYAL MARBLES LIGHT BARDIGLIO  
(sfuso) 7,5x15 Cod. **95** □

**040974**  
ROYAL MARBLES LIGHT BARDIGLIO  
LAPPATO (sfuso) 7,5x15 Cod. **111** □

IMBALLI • PACKAGES • EMBALLAGES • FORMATE

	SCATOLA • BOX • BOITE • KARTON			PALLET • PALLETS • PALETTS • PALETTE		
	pz	mq	kg	box	mq	kg
<b>30x60</b>	6	1,08	22,60	40	43,20	904,00
<b>15x60</b>	10	0,90	18,80	48	43,20	904,00
<b>30x30</b>	11	0,99	21,20	46	45,54	975,00
<b>10x30</b>	20	0,60	12,90	60	36,00	774,00
<b>15x15</b>	46	1,035	21,70	33	34,15	715,00
<b>7,5x15</b>	50	0,56	11,70	76	42,56	890,00
<b>10x10</b>	50	0,50	10,50	36	18,00	376,00



**490489**  
ROYAL MARBLES MARFIL SELECT RETTIFICATO 30x60  
Cod. **76** □

**490491**  
ROYAL MARBLES MARFIL SELECT LAPPATO RETTIFICATO 30x60  
Cod. **85** □

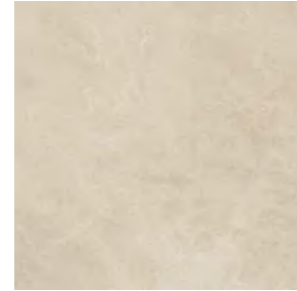

**040969**  
ROYAL MARBLES MARFIL SELECT  
RETTIFICATO 30x30 Cod. **78** □

**040970**  
ROYAL MARBLES MARFIL SELECT  
LAPPATO RETTIFICATO 30x30 Cod. **90** □

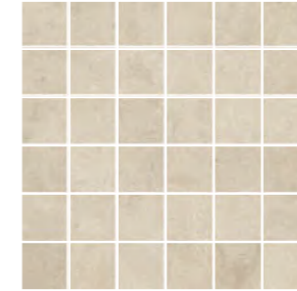

**040993**  
ROYAL MARBLES MARFIL SELECT  
MOSAICO 5x5 SU RETE 30x30  
Cod. **24** ○

**040994**  
ROYAL MARBLES MARFIL SELECT LAPPATO  
MOSAICO 5x5 SU RETE 30x30  
Cod. **31** ○



**040999**  
ROYAL MARBLES MARFIL SELECT  
MURETTO 2,4x10 SU RETE 30x30  
Cod. **46** ○

**041000**  
ROYAL MARBLES MARFIL SELECT LAPPATO  
MURETTO 2,4x10 SU RETE 30x30  
Cod. **58** ○

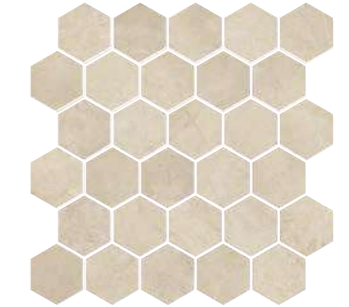

**040981**  
ROYAL MARBLES MARFIL SELECT MOSAICO  
ESAGONO SU RETE 27x28  
Cod. **136** ○

**040982**  
ROYAL MARBLES MARFIL SELECT LAPPATO  
MOSAICO ESAGONO SU RETE 27x28  
Cod. **49** ○



**550105**  
ROYAL MARBLES MARFIL SELECT RETTIFICATO 15x60  
Cod. **95** □

**550106**  
ROYAL MARBLES MARFIL SELECT LAPPATO RETTIFICATO 15x60  
Cod. **111** □



**230255**  
ROYAL MARBLES MARFIL SELECT  
RETTIFICATO 15x15 Cod. **78** □

**230256**  
ROYAL MARBLES MARFIL SELECT  
LAPPATO RETTIFICATO 15x15 Cod. **90** □

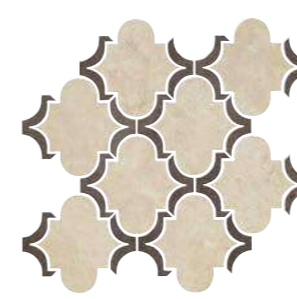

**041177**  
ROYAL MARBLES MARFIL SELECT NATURALE  
MOSAICO ARABESQUE SU RETE 30x30  
Cod. **57** ○

**041178**  
ROYAL MARBLES MARFIL SELECT LAPPATO  
MOSAICO ARABESQUE SU RETE 30x30  
Cod. **72** ○



**040987**  
ROYAL MARBLES MARFIL SELECT  
MOSAICO BASKETWAVE SU RETE 30x30  
Cod. **47** ○

**040988**  
ROYAL MARBLES MARFIL SELECT LAPPATO  
MOSAICO BASKETWAVE SU RETE 30x30  
Cod. **60** ○



**380232**  
ROYAL MARBLES MARFIL SELECT  
BORDURA MURETTO SU RETE 7x30  
Cod. **28** ○

**380233**  
ROYAL MARBLES MARFIL SELECT LAPPATO  
BORDURA MURETTO SU RETE 7x30  
Cod. **28** ○



**103076**  
ROYAL MARBLES MARFIL SELECT  
RETTIFICATO 10x30 Cod. **77** □

**103077**  
ROYAL MARBLES MARFIL SELECT  
LAPPATO RETTIFICATO 10x30 Cod. **93** □



**450375**  
ROYAL MARBLES MARFIL SELECT  
RETTIFICATO (sfuso) 10x10 Cod. **90** □

**450376**  
ROYAL MARBLES MARFIL SELECT  
LAPPATO RETTIFICATO (sfuso) 10x10 Cod. **106** □



**380226**  
ROYAL MARBLES MARFIL SELECT  
NATURALE LONDON 5x30  
Cod. **33** ○

**380227**  
ROYAL MARBLES MARFIL SELECT  
LUCIDO LONDON 5x30  
Cod. **33** ○

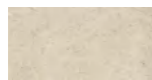

**040975**  
ROYAL MARBLES MARFIL SELECT  
(sfuso) 7,5x15 Cod. **95** □

**040976**  
ROYAL MARBLES MARFIL SELECT  
LAPPATO (sfuso) 7,5x15 Cod. **111** □

## IMBALLI • PACKAGES • EMBALLAGES • FORMATE

	SCATOLA • BOX • BOITE • KARTON			PALLET • PALLETS • PALETTS • PALETTE		
	pz	mq	kg	box	mq	kg
<b>30x60</b>	6	1,08	22,60	40	43,20	904,00
<b>15x60</b>	10	0,90	18,80	48	43,20	904,00
<b>30x30</b>	11	0,99	21,20	46	45,54	975,00
<b>10x30</b>	20	0,60	12,90	60	36,00	774,00
<b>15x15</b>	46	1,035	21,70	33	34,15	715,00
<b>7,5x15</b>	50	0,56	11,70	76	42,56	890,00
<b>10x10</b>	50	0,50	10,50	36	18,00	376,00



## royal marbles RETT. LAPPATO

La finitura lappata è consigliata per uso rivestimento o per pavimenti da bagno in ambito residenziale. Nello specifico il tipo di pavimentazione deve essere non soggetta ad eccessive sollecitazioni e mai a diretto contatto con aree esterne. Come si verifica comunemente nelle pietre naturali l'eventuale presenza di puntini sulla superficie o di qualche disuniformità della lucentezza sono da considerare caratteristiche del prodotto derivanti dalla lavorazione a cui viene sottoposto.

The polished finish is recommended for wall coverings or for the floors of residential bathrooms. Specifically, floor coverings in this material must not be subjected to excessively heavy traffic and must never be in direct contact with outdoor areas. As is often the case with natural stones, any spots on the surface or any unevenness in shine are typical characteristics of the product, deriving from the process used.

La finition polie est recommandée pour le revêtement sol et mur des salles de bains résidentielles. Notamment, ce type de carreau au sol ne doit pas être exposé à des contraintes excessives, et il ne doit jamais être en contact direct avec des zones extérieures. Comme cela est souvent le cas pour les pierres naturelles, les micro trous éventuellement présents à la surface du produit ou l'hétérogénéité de son éclat forment des caractéristiques propres au façonnage.

Die polierte Oberfläche wird für Wandverkleidungen und Bodenbeläge in Privatbädern empfohlen. Der Bodenbelag darf keinen starken Beanspruchungen ausgesetzt sein und keinen direkten Kontakt zu Außenbereichen haben. Wie bei Natursteinen üblich, kann die Oberfläche Körnungen oder einen unregelmäßigen Glanz aufweisen. Diese Merkmale sind typische, beabsichtigte Produkteigenschaften, die durch das Bearbeitungsverfahren hervorgerufen werden.

Pezzi speciali • Special trims • Pièces spéciales • Formstücke

Battiscopa



**290628**  
ROYAL MARBLES LIGHT BARDIGLIO  
BATTISCOPA NATURALE 7x30  
Cod. **116** △

**290630**  
ROYAL MARBLES MARFIL SELECT  
BATTISCOPA NATURALE 7x30  
Cod. **116** △



**290629**  
ROYAL MARBLES LIGHT BARDIGLIO  
BATTISCOPA LAPPATO 7x30  
Cod. **22** △

**290631**  
ROYAL MARBLES MARFIL SELECT  
BATTISCOPA LAPPATO 7x30  
Cod. **22** △

CARATTERISTICHE DI QUALITÀ QUALITY CHARACTERISTICS CARACTERISTIQUES DE QUALITÉ QUALITÄTSEIGENSCHAFTEN	NORMA NORM NORME NORME	REQUISITO NORMA REQUIRED STANDARDS VALEUR PRESCRITE SELON LA NORME NORMVORGABE	RISULTATO RESULT RESULTAT ERGEBNISS
Assorbimento d'acqua Water absorption of the body Absorption d'eau de support Wasseraufnahme des Scherbens	ISO 10545-3	≤ 0,5	Conforme Conformity Conforme Gemäss
Resistenza a flessione Breaking strenght Résistance à la flexion Biegefestigkeit	ISO 10545-4	≥ 35 N/mm <sup>2</sup>	Conforme Conformity Conforme Gemäss
Resistenza all'abrasione Abrasion resistance Résistance à l'abrasion Abriebbeständigkeit	ISO 10545-7	Royal Marbles Rettificato Royal Marbles Lappato	PEI IV
Resistenza al gelo Frost resistance Résistance au gel Frostbeständigkeit	ISO 10545-12	Nessun campione deve presentare rotture o alterazioni apprezzabili alla superficie No samples must show ruptures or noticeable surface alteration Aucuns enchantions doit présenter ruptures ou altérations appréciables de la surface Keines der Muster sollte Risse oder sichtbare Fehler der Oberfläche zeigen	Conforme Conformity Conforme Gemäss
Resistenza all'attacco chimico Chemical resistance Résistance à l'attaque chimique Beständigkeit gegen chemikalien	ISO 10545-13	Royal Marbles Rettificato Royal Marbles Lappato	GA GLA GA GLB
Resistenza agli sbalzi termici Thermal shock resistance Résistance aux écarts de température Temperaturwechselbeständigkeit	ISO 10545-5		Conforme Conformity Conforme Gemäss
Resistenza scivolosità Sliding resistance Résistance au glissement Rutschfestigkeit	DIN 51130 R	Royal Marbles Rettificato Royal Marbles Lappato	R9
Significativa variazione Significant variation Variation important Bedeutsam Abweichung			V3

**V1**  
Aspetto uniforme  
Uniform appearance  
Aspect uniforme  
Einheitliches Aussehen

**V2**  
Lieve variazione  
Slight variation  
Légère variation  
Geringe Abweichung

**V3**  
Significativa variazione  
Significant variation  
Variation important  
Bedeutsam Abweichung

**V4**  
Forte stonalizzazione  
Substantial variation  
Effet dénuancé très accentué  
Akzentuierte Variation

**PER UNA POSA OTTIMALE DEL PRODOTTO CONSIGLIAMO SEMPRE DI MESCOLARE ALMENO TRE SCATOLE DI MATERIALE.**  
For the best product laying results, material from at least three boxes should be mixed.  
Pour une pose excellente, nous recommandons toujours de mélanger le contenu d'au moins trois boîtes.  
Für eine optimale Verlegung des Erzeugnisses empfehlen wir stets, mindestens drei Packungen Material anzumischen.





Tipologia  
Type  
Typologie  
Typ  
Gres porcellanato smaltato  
Glazed porcelain  
Grès cérame emaille  
Feinsteinzeug glasiert

Formati R10 A+B  
Sizes  
Formats  
Formate  
60x120  
20x120  
40x80  
20x80  
60x60  
30x60  
30x30  
10x30  
5x20

Spessore  
Thickness  
Épaisseur  
Stärke  
9 mm

Formati R11 A+B+C  
30x60

Resistenza scivolosità  
Sliding resistance  
Resistance au glissement  
Rutschfestigkeit  
R10 / A+B  
R11 / A+B+C

Grado di variazione cromatica  
Degree of colour change  
Degré de variation chromatique  
Grad der Farbabweichung  
V3



**601238**  
SLIDE BLACK RETTIFICATO 60x120  
Cod. **94** □



**201216**  
SLIDE BLACK RETTIFICATO 20x120  
Cod. **111** □

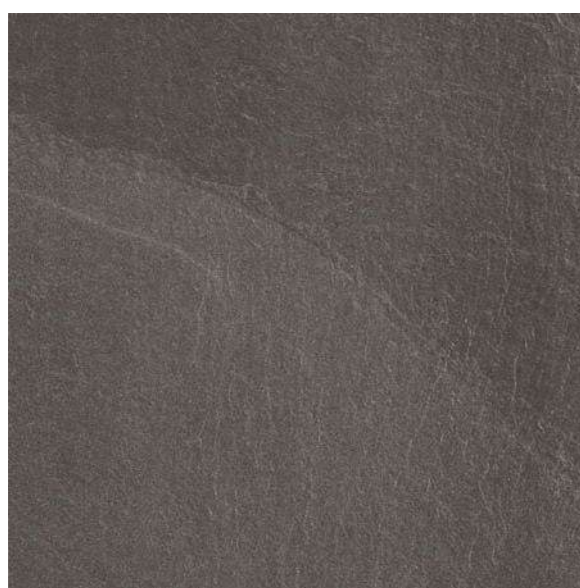

**606165**  
SLIDE BLACK RETTIFICATO 60x60  
Cod. **79** □



**490500**  
SLIDE BLACK RETTIFICATO 30x60  
Cod. **76** □

**490504**  
SLIDE BLACK RETTIFICATO **R11** 30x60  
Cod. **77** □



**041015**  
SLIDE BLACK RETTIFICATO 30x30  
Cod. **78** □



**103085**  
SLIDE BLACK RETTIFICATO 10x30  
Cod. **77** □



**408111**  
SLIDE BLACK RETTIFICATO 40x80  
Cod. **79** □



**208043**  
SLIDE BLACK RETTIFICATO 20x80  
Cod. **89** □



**041027**  
SLIDE BLACK MOSAICO ESAGONO  
LATO 4,5 SU RETE 30x26  
Cod. **128** ○

6  
7,90 kg



**272902**  
SLIDE INTARSIO HYDRO BLACK-WHITE  
10,5x10,5 SU RETE 21x21 Cod. **62** ○

6  
3,50 kg



**050214**  
SLIDE BLACK 5x20  
Cod. **93** □



**310196**  
SLIDE BLACK LONDON 3,5x30  
Cod. **33** ○

24  
2,80 kg

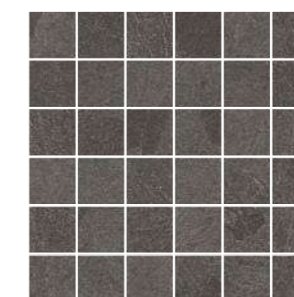

**041018**  
SLIDE BLACK MOSAICO 5x5  
SU RETE 30x30 Cod. **24** ○

6  
9,12 kg

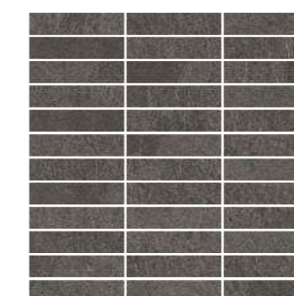

**041021**  
SLIDE BLACK MOSAICO 2,4x10  
SU RETE 30x30 Cod. **46** ○

6  
9,12 kg

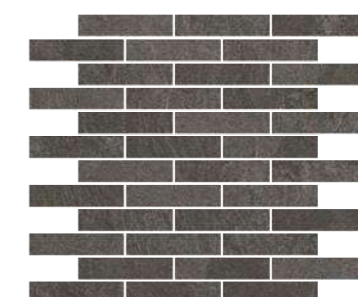

**041024**  
SLIDE BLACK MOSAICO MURETTO 2,4x10  
SU RETE 30x30 Cod. **46** ○

6  
9,12 kg



**380241**  
SLIDE BLACK BORDURA WAVE 7x30  
Cod. **16** ○

12  
4,20 kg



**380238**  
SLIDE BLACK BORDURA WAVE 14x30  
Cod. **33** ○

6  
4,20 kg

IMBALLI • PACKAGES • EMBALLAGES • FORMATE

	SCATOLA • BOX • BOITE • KARTON			PALLET • PALLETS • PALETTS • PALETTE		
	pz	mq	kg	box	mq	kg
<b>60x120</b>	2	1,44	28,70	30	43,20	861,00
<b>20x120</b>	4	0,96	19,10	30	28,80	574,00
<b>40x80</b>	3	0,96	19,10	56	53,76	1.070,00
<b>20x80</b>	6	0,96	19,10	42	40,32	802,00
<b>60x60</b>	3	1,08	21,30	40	43,20	852,00
<b>30x60-30x60 R11</b>	6	1,08	21,30	40	43,20	852,00
<b>30x30</b>	11	0,99	19,50	46	45,54	897,00
<b>10x30</b>	20	0,60	12,50	60	36,00	750,00
<b>5x20</b>	56	0,56	11,70	60	33,60	702,00



**601239**  
SLIDE GREY RETTIFICATO 60x120  
Cod. **94** □



**201217**  
SLIDE GREY RETTIFICATO 20x120  
Cod. **111** □



**606166**  
SLIDE GREY RETTIFICATO 60x60  
Cod. **79** □



**490501**  
SLIDE GREY RETTIFICATO 30x60  
Cod. **76** □

**490505**  
SLIDE GREY RETTIFICATO **R11** 30x60  
Cod. **77** □



**041016**  
SLIDE GREY RETTIFICATO 30x30  
Cod. **78** □



**103086**  
SLIDE GREY RETTIFICATO 10x30  
Cod. **77** □



**408112**  
SLIDE GREY RETTIFICATO 40x80  
Cod. **79** □



**208044**  
SLIDE GREY RETTIFICATO 20x80  
Cod. **89** □



**041028**  
SLIDE GREY MOSAICO ESAGONO  
LATO 4,5 SU RETE 30x26  
Cod. **128** ○

6  
7,90 kg

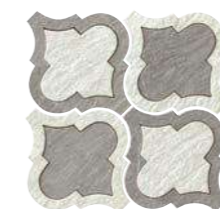

**272901**  
SLIDE INTARSIO HYDRO GREY-WHITE  
10,5x10,5 SU RETE 21x21 Cod. **62** ○

6  
3,50 kg



**050215**  
SLIDE GREY 5x20  
Cod. **93** □



**310197**  
SLIDE GREY LONDON 3,5x30  
Cod. **33** ○

24  
2,80 kg

IMBALLI • PACKAGES • EMBALLAGES • FORMATE

	SCATOLA • BOX • BOITE • KARTON			PALLET • PALLETS • PALETTS • PALETTE		
	pz	m <sup>2</sup>	kg	box	m <sup>2</sup>	kg
<b>60x120</b>	2	1,44	28,70	30	43,20	861,00
<b>20x120</b>	4	0,96	19,10	30	28,80	574,00
<b>40x80</b>	3	0,96	19,10	56	53,76	1.070,00
<b>20x80</b>	6	0,96	19,10	42	40,32	802,00
<b>60x60</b>	3	1,08	21,30	40	43,20	852,00
<b>30x60-30x60 R11</b>	6	1,08	21,30	40	43,20	852,00
<b>30x30</b>	11	0,99	19,50	46	45,54	897,00
<b>10x30</b>	20	0,60	12,50	60	36,00	750,00
<b>5x20</b>	56	0,56	11,70	60	33,60	702,00



**041019**  
SLIDE GREY MOSAICO 5x5  
SU RETE 30x30 Cod. **24** ○

6  
9,12 kg

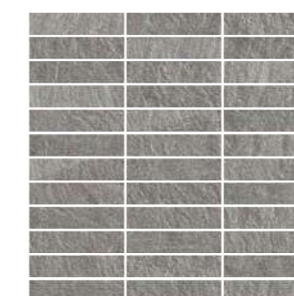

**041022**  
SLIDE GREY MOSAICO 2,4x10  
SU RETE 30x30 Cod. **46** ○

6  
9,12 kg

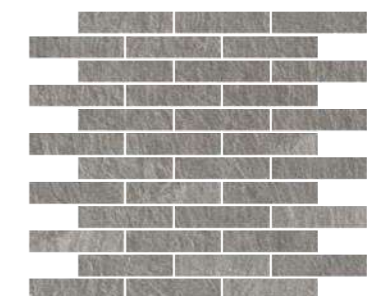

**041025**  
SLIDE GREY MOSAICO MURETTO 2,4x10  
SU RETE 30x30 Cod. **46** ○

6  
9,12 kg



**380242**  
SLIDE GREY BORDURA WAVE 7x30  
Cod. **16** ○

12  
4,20 kg



**380239**  
SLIDE GREY BORDURA WAVE 14x30  
Cod. **33** ○

6  
4,20 kg



**601240**  
SLIDE WHITE RETTIFICATO 60x120  
Cod. **94** □



**201218**  
SLIDE WHITE RETTIFICATO 20x120  
Cod. **111** □



**606167**  
SLIDE WHITE RETTIFICATO 60x60  
Cod. **79** □



**490502**  
SLIDE WHITE RETTIFICATO 30x60  
Cod. **76** □

**490506**  
SLIDE WHITE RETTIFICATO **R11** 30x60  
Cod. **77** □



**041017**  
SLIDE WHITE RETTIFICATO 30x30  
Cod. **78** □

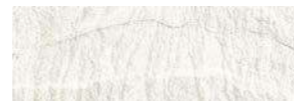

**103087**  
SLIDE WHITE RETTIFICATO 10x30  
Cod. **77** □



**408113**  
SLIDE WHITE RETTIFICATO 40x80  
Cod. **79** □



**208045**  
SLIDE WHITE RETTIFICATO 20x80  
Cod. **89** □

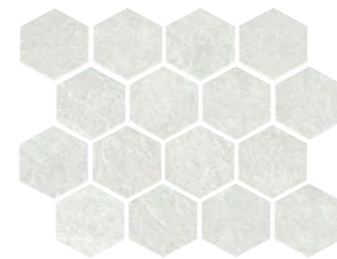

**041029**  
SLIDE WHITE MOSAICO ESAGONO  
LATO 4,5 SU RETE 30x26  
Cod. **128** ○



**050216**  
SLIDE WHITE 5x20  
Cod. **93** □



**272901**  
SLIDE INTARSIO HYDRO GREY-WHITE  
10,5x10,5 SU RETE 21x21 Cod. **62** ○



**272902**  
SLIDE INTARSIO HYDRO BLACK-WHITE  
10,5x10,5 SU RETE 21x21 Cod. **62** ○

IMBALLI • PACKAGES • EMBALLAGES • FORMATE

	SCATOLA • BOX • BOITE • KARTON			PALLET • PALLETS • PALETTS • PALETTE		
	pz	m <sup>q</sup>	kg	box	m <sup>q</sup>	kg
<b>60x120</b>	2	1,44	28,70	30	43,20	861,00
<b>20x120</b>	4	0,96	19,10	30	28,80	574,00
<b>40x80</b>	3	0,96	19,10	56	53,76	1.070,00
<b>20x80</b>	6	0,96	19,10	42	40,32	802,00
<b>60x60</b>	3	1,08	21,30	40	43,20	852,00
<b>30x60-30x60 R11</b>	6	1,08	21,30	40	43,20	852,00
<b>30x30</b>	11	0,99	19,50	46	45,54	897,00
<b>10x30</b>	20	0,60	12,50	60	36,00	750,00
<b>5x20</b>	56	0,56	11,70	60	33,60	702,00



**041020**  
SLIDE WHITE MOSAICO 5x5  
SU RETE 30x30 Cod. **24** ○



**041023**  
SLIDE WHITE MOSAICO 2,4x10  
SU RETE 30x30 Cod. **46** ○



**310198**  
SLIDE WHITE LONDON 3,5x30  
Cod. **33** ○



**041026**  
SLIDE WHITE MOSAICO MURETTO 2,4x10  
SU RETE 30x30 Cod. **46** ○











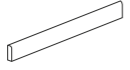

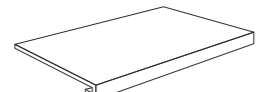
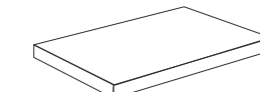
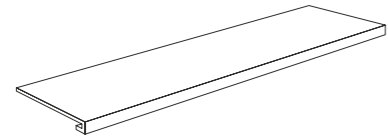
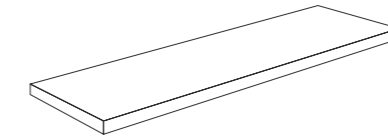
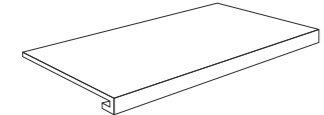
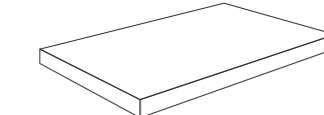

**380243**  
SLIDE WHITE BORDURA WAVE 7x30  
Cod. **16** ○



**380240**  
SLIDE WHITE BORDURA WAVE 14x30  
Cod. **33** ○

Pezzi speciali • Special trims • Pièces spéciales • Formstücke

Battiscopa		40 8,55 kg	20 8,55 kg
	<b>290644</b> SLIDE BLACK BATTISCOPIA 5x30 Cod. <b>116</b> △		<b>290647</b> SLIDE BLACK BATTISCOPIA 5x60 Cod. <b>121</b> △
	<b>290645</b> SLIDE GREY BATTISCOPIA 5x30 Cod. <b>116</b> △		<b>290648</b> SLIDE GREY BATTISCOPIA 5x60 Cod. <b>121</b> △
	<b>290646</b> SLIDE WHITE BATTISCOPIA 5x30 Cod. <b>116</b> △		<b>290649</b> SLIDE WHITE BATTISCOPIA 5x60 Cod. <b>121</b> △
Gradino		2 8,00 kg	2 10,00 kg
	<b>490530</b> SLIDE BLACK GRADINO 33x60 Cod. <b>112</b> ○		<b>490548</b> SLIDE BLACK ANGOLARE 33x60 Cod. <b>107</b> ○
	<b>490531</b> SLIDE GREY GRADINO 33x60 Cod. <b>112</b> ○		<b>490549</b> SLIDE GREY ANGOLARE 33x60 Cod. <b>107</b> ○
	<b>490532</b> SLIDE WHITE GRADINO 33x60 Cod. <b>112</b> ○		<b>490350</b> SLIDE WHITE ANGOLARE 33x60 Cod. <b>107</b> ○
Gradino		2 16,00 kg	2 20,00 kg
	<b>490527</b> SLIDE BLACK GRADINO 33x120 Cod. <b>114</b> ○		<b>490545</b> SLIDE BLACK ANGOLARE 33x120 Cod. <b>110</b> ○
	<b>490528</b> SLIDE GREY GRADINO 33x120 Cod. <b>114</b> ○		<b>490546</b> SLIDE GREY ANGOLARE 33x120 Cod. <b>110</b> ○
	<b>490529</b> SLIDE WHITE GRADINO 33x120 Cod. <b>114</b> ○		<b>490547</b> SLIDE WHITE ANGOLARE 33x120 Cod. <b>110</b> ○
Gradino		2 10,70 kg	2 13,50 kg
	<b>408119</b> SLIDE BLACK GRADINO 40x80 Cod. <b>109</b> ○		<b>408127</b> SLIDE BLACK ANGOLARE 40x80 Cod. <b>113</b> ○
	<b>408120</b> SLIDE GREY GRADINO 40x80 Cod. <b>109</b> ○		<b>408128</b> SLIDE GREY ANGOLARE 40x80 Cod. <b>113</b> ○
	<b>408121</b> SLIDE WHITE GRADINO 40x80 Cod. <b>109</b> ○		<b>408129</b> SLIDE WHITE ANGOLARE 40x80 Cod. <b>113</b> ○

CARATTERISTICHE DI QUALITÀ Quality characteristics Caractéristiques de qualité Qualitätseigenschaften	NORMA Norm Norme Norme	REQUISITO NORMA Required standards Valeur prescrite selon la norme Normvorgabe	RISULTATO Result Résultat Ergebniss
 Assorbimento d'acqua Water absorption of the body Absorption d'eau de support Wasseraufnahme des Scherbens	ISO 10545-3	≤ 0,5	Conforme Conformity Conforme Gemäss
 Resistenza a flessione Breaking strenght Résistance à la flexion Biegefestigkeit	ISO 10545-4	≥ 35 N/mm²	Conforme Conformity Conforme Gemäss
 Resistenza all'abrasione Abrasion resistance Resistance a l'abrasion Abriebbeständigkeit	EN ISO 10545-7	WHITE - GREY	PEI V
		BLACK	PEI IV
 Resistenza al gelo Frost resistance Résistance au gel Frostbeständigkeit	ISO 10545-12	Nessun campione deve presentare rotture o alterazioni apprezzabili alla superficie No samples must show ruptures or noticeable surface alteration Aucuns enchantions doit présenter ruptures ou altérations appréciables de la surface Keines der Muster sollte Risse oder sichtbare Fehler der Oberfläche zeigen	Conforme Conformity Conforme Gemäss
 Resistenza all'attacco chimico Chemical resistance Résistance à l'attaque chimique Beständigkeit gegen chemikalien	ISO 10545-13		GA GLA
 Resistenza agli sbalzi termici Thermal shock resistance Resistance aux écarts de température Temperaturwechselbeständigkeit	ISO 10545-5		Conforme Conformity Conforme Gemäss
 Resistenza scivolosità Sliding resistance Resistance au glissement Rutschfestigkeit	DIN 51130 R	Slide Rettificato	R10
		Slide 30x60 R11	R11
 Resistenza scivolosità Sliding resistance Resistance au glissement Rutschfestigkeit	DIN 51097 (A+B+C)	Slide Rettificato	A+B
		Slide 30x60 R11	A+B+C
 Coefficiente d'attrito dinamico Wet dynamic coefficient of friction Coefficient de friction dynamique Reibungskoeffizient Schlupfgrigkeit (in Bewegung)	Bot 3000 E	DCOF ≥ 0,42	> 0,42
 Significativa variazione Significant variation Variation important Bedeutsam Abweichung			V3

**V1**  
Aspetto uniforme  
Uniform appearance  
Aspect uniforme  
Einheitliches Aussehen

**V2**  
Lieve variazione  
Slight variation  
Légère variation  
Geringe Abweichung

**V3**  
Significativa variazione  
Significant variation  
Variation important  
Bedeutsam Abweichung

**V4**  
Forte stonizzazione  
Substantial variation  
Effet dénuancé très accentué  
Akzentuierte Variation

**PER UNA POSA OTTIMALE DEL PRODOTTO CONSIGLIAMO SEMPRE DI MESCOLARE ALMENO TRE SCATOLE DI MATERIALE.**  
For the best product laying results, material from at least three boxes should be mixed.  
Pour une pose excellente, nous recommandons toujours de mélanger le contenu d'au moins trois boîtes.  
Für eine optimale Verlegung des Erzeugnisses empfehlen wir stets, mindestens drei Packungen Material anzumischen.



Tipologia  
Type  
Typologie  
Typ  
Gres porcellanato smaltato  
Glazed porcelain  
Grès cérame emaille  
Feinsteinzeug glasiert

Formati  
Sizes  
Formats  
Formate  
20x20

Spessore  
Thickness  
Épaisseur  
Stärke  
10 mm

Resistenza scivolosità  
Sliding resistance  
Resistance au glissement  
Rutschfestigkeit  
R10

Grado di variazione cromatica  
Degree of colour change  
Degré de variation chromatique  
Grad der Farbabweichung  
V3



**130046**  
STAGE COZY BLEND RETTIFICATO  
20x20  
Cod. **81** □

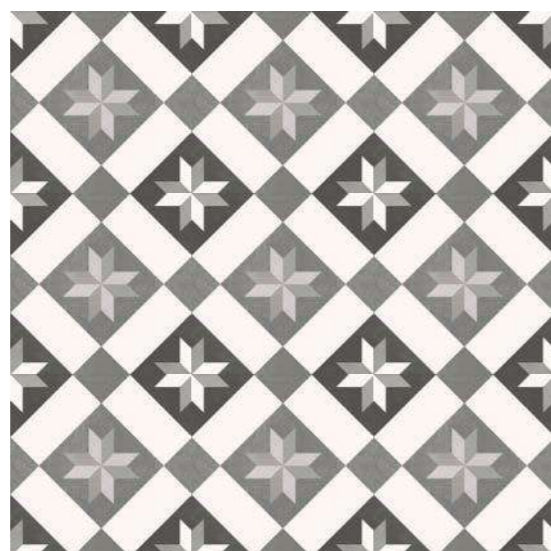

**130042**  
STAGE COZY No.1  
RETTIFICATO 20x20  
Cod. **81** □

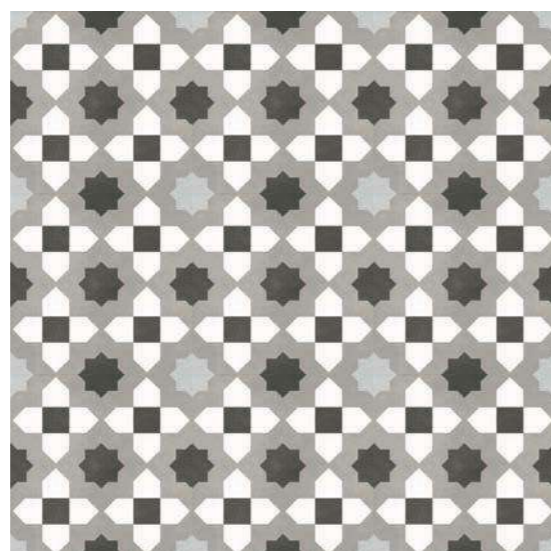

**130043**  
STAGE COZY No.2  
RETTIFICATO 20x20  
Cod. **81** □



**130044**  
STAGE COZY No.3  
RETTIFICATO 20x20  
Cod. **81** □



**130045**  
STAGE COZY No.4  
RETTIFICATO 20x20  
Cod. **81** □



**130047**  
STAGE COZY No.5  
RETTIFICATO 20x20  
Cod. **81** □



**130048**  
STAGE COZY No.6  
RETTIFICATO 20x20  
Cod. **81** □

**IMBALLI • PACKAGES • EMBALLAGES • FORMATE**

SCATOLA • BOX • BOITE • KARTON  
PALLET • PALLETS • PALETTS • PALETTE

	<i>pz</i>	<i>mq</i>	<i>kg</i>
<b>20x20</b>	16	0,64	12,63
	<i>box</i>	<i>mq</i>	<i>kg</i>
	72	46,08	910,00



**130041**  
STAGE HIPSTER BLEND  
RETTIFICATO 20x20  
Cod. **81** □



**130037**  
STAGE HIPSTER No.1  
RETTIFICATO 20x20  
Cod. **81** □



**130038**  
STAGE HIPSTER No.2  
RETTIFICATO 20x20  
Cod. **81** □



**130039**  
STAGE HIPSTER No.3  
RETTIFICATO 20x20  
Cod. **81** □

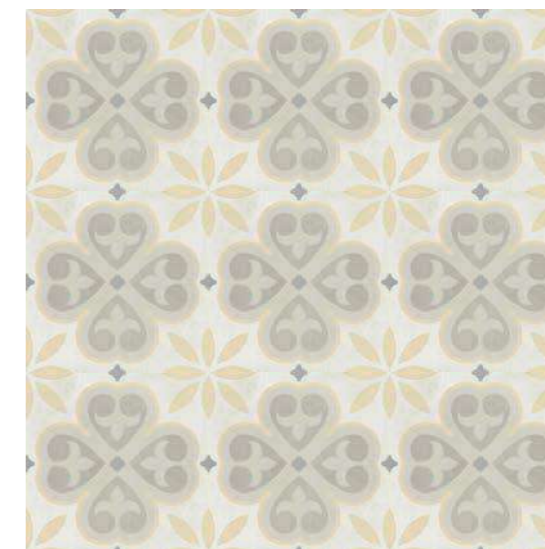

**130040**  
STAGE HIPSTER No.4  
RETTIFICATO 20x20  
Cod. **81** □



**130049**  
STAGE HIPSTER No.5  
RETTIFICATO 20x20  
Cod. **81** □

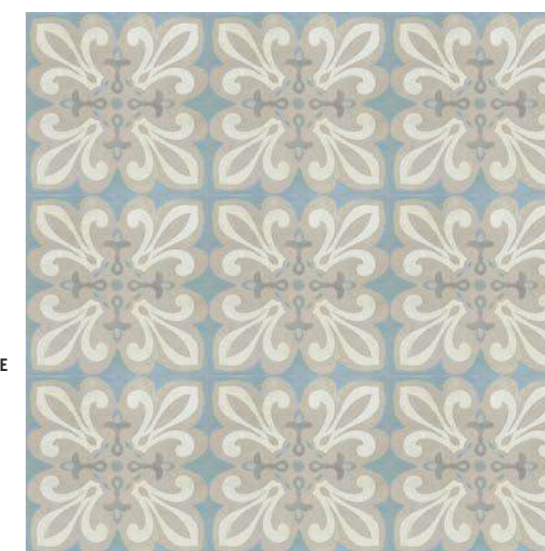

**130050**  
STAGE HIPSTER No.6  
RETTIFICATO 20x20  
Cod. **81** □

**IMBALLI • PACKAGES • EMBALLAGES • FORMATE**

SCATOLA • BOX • BOITE • KARTON  
PALLET • PALLETS • PALETTS • PALETTE

	<i>pz</i>	<i>mq</i>	<i>kg</i>
<b>20x20</b>	16	0,64	12,63
	<i>box</i>	<i>mq</i>	<i>kg</i>
	72	46,08	910,00





**130036**  
STAGE SHABBY CHIC BLEND  
RETTIFICATO 20x20  
Cod. **81** □



**130032**  
STAGE SHABBY CHIC No.1  
RETTIFICATO 20x20  
Cod. **81** □



**130033**  
STAGE SHABBY CHIC No.2  
RETTIFICATO 20x20  
Cod. **81** □

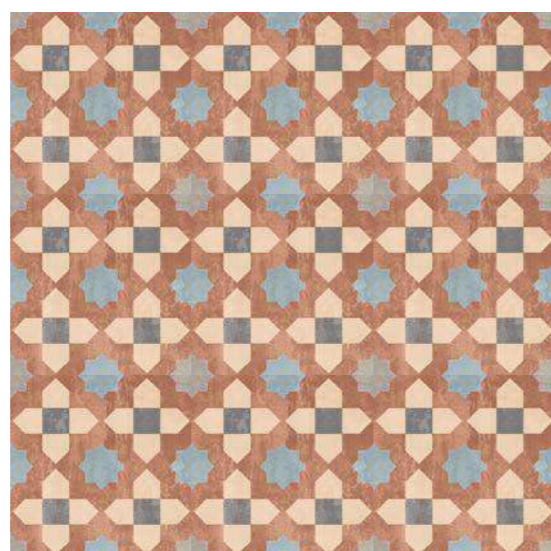

**130034**  
STAGE SHABBY CHIC No.3  
RETTIFICATO 20x20  
Cod. **81** □

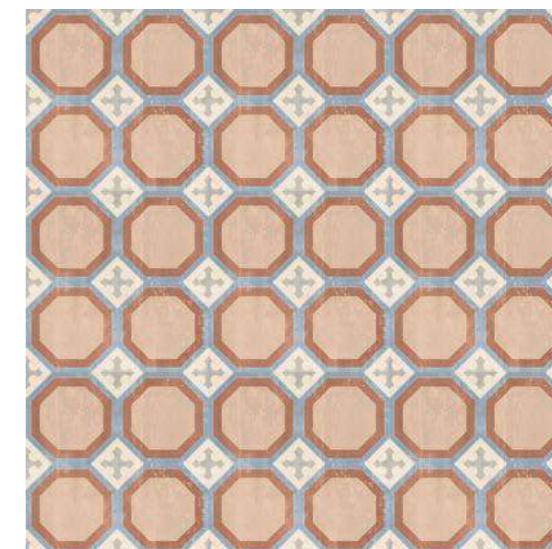

**130035**  
STAGE SHABBY CHIC No.4  
RETTIFICATO 20x20  
Cod. **81** □

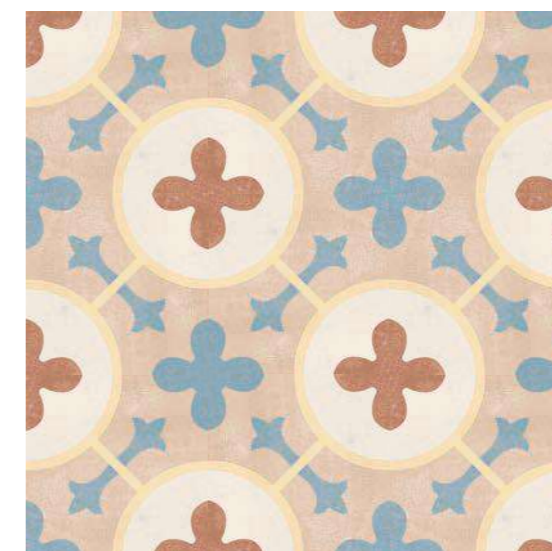

**130051**  
stage SHABBY CHIC No.5  
RETTIFICATO 20x20  
Cod. **81** □

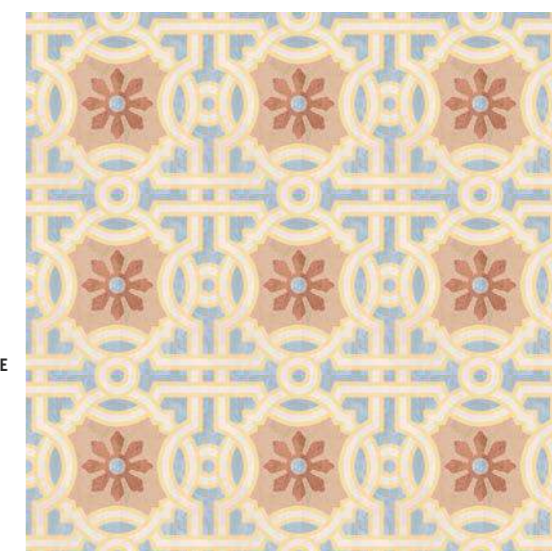

**130052**  
STAGE SHABBY CHIC No.6  
RETTIFICATO 20x20  
Cod. **81** □

**IMBALLI • PACKAGES • EMBALLAGES • FORMATE**

SCATOLA • BOX • BOITE • KARTON  
PALLET • PALLETS • PALETTS • PALETTE

	<i>pz</i>	<i>mq</i>	<i>kg</i>
<b>20x20</b>	16	0,64	12,63
	<i>box</i>	<i>mq</i>	<i>kg</i>
	72	46,08	910,00



CARATTERISTICHE DI QUALITÀ Quality characteristics Caractéristiques de qualité Qualitätseigenschaften	NORMA Norm Norme Norme	REQUISITO NORMA Required standards Valeur prescrite selon la norme Normvorgabe	RISULTATO Result Résultat Ergebniss
Assorbimento d'acqua Water absorption of the body Absorption d'eau de support Wasseraufnahme des Scherbens		≤ 0,5	Conforme Conformity Conforme Gemäss
Resistenza a flessione Breaking strenght Résistance à la flexion Biegefestigkeit	ISO 10545-4	≥ 35 N/mm <sup>2</sup>	Conforme Conformity Conforme Gemäss
Resistenza all'abrasione Abrasion resistance Resistance a l'abrasion Abriebbeständigkeit	ISO 10545-7		PEI IV
Resistenza al gelo Frost resistance Résistance au gel Frostbeständigkeit	ISO 10545-12	Nessun campione deve presentare rotture o alterazioni apprezzabili alla superficie No samples must show ruptures or noticeable surface alteration Aucuns enchantions doit présenter ruptures ou altérations appréciables de la surface Keines der Muster sollte Risse oder sichtbare Fehler der Oberfläche zeigen	Conforme Conformity Conforme Gemäss
Resistenza all'attacco chimico Chemical resistance Résistance à l'attaque chimique Beständigkeit gegen chemikalien	ISO 10545-13		GA GLA
Resistenza agli sbalzi termici Thermal shock resistance Resistance aux écarts de température Temperaturwechselbeständigkeit	ISO 10545-5		Conforme Conformity Conforme Gemäss
Resistenza scivolosità Sliding resistance Resistance au glissement Rutschfestigkeit	DIN 51130 R		R10
Coefficiente d'attrito dinamico Wet dynamic coefficient of friction Coefficient de friction dynamique Reibungskoeffizient Schlupfingkeit (in Bewegung)	Bot 3000 E	DCOF ≥ 0,42	> 0,42
Significativa variazione Significant variation Variation important Bedeutsam Abweichung			V3

Aspetto uniforme  
Uniform appearance  
Aspect uniforme  
Einheitliches Aussehen  
**V1**

Lieve variazione  
Slight variation  
Légère variation  
Geringe Abweichung  
**V2**

Significativa variazione  
Significant variation  
Variation important  
Bedeutsam Abweichung  
**V3**

Forte stonizzazione  
Substantial variation  
Effet dénuancé très accentué  
Akzentuierte Variation  
**V4**



Tipologia  
Type  
Typologie  
Typ  
Gres porcellanato smaltato  
Glazed porcelain  
Grès cérame emaille  
Feinsteinzeug glasiert

Formati  
Sizes  
Formats  
Formate  
120x120  
60x120  
30x120  
60x60  
30x60  
15x60  
30x30  
10x30  
15x15  
7,5x15

Spessore  
Thickness  
Épaisseur  
Stärke  
9 mm

Resistenza scivolosità  
Sliding resistance  
Resistance au glissement  
Rutschfestigkeit  
R9

Grado di variazione cromatica  
Degree of colour change  
Degré de variation chromatique  
Grad der Farbabweichung  
V3



**121207**  
STAT ONE NATURALE RETTIFICATO 120x120  
Cod. **100** □

**121208**  
STAT ONE LAPPATO RETTIFICATO 120x120  
Cod. **141** □



**601247**  
STAT ONE NATURALE  
RETTIFICATO 60x120  
Cod. **94** □

**601248**  
STAT ONE LAPPATO  
RETTIFICATO 60x120  
Cod. **103** □



**301242**  
STAT ONE NATURALE  
RETTIFICATO 30x120  
Cod. **99** □

**301243**  
STAT ONE LAPPATO  
RETTIFICATO 30x120  
Cod. **106** □

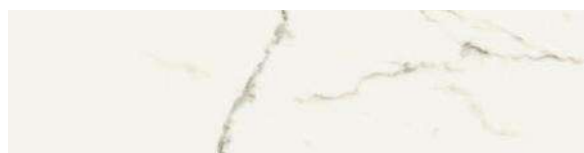

**550111**  
STAT ONE NATURALE RETTIFICATO 15x60  
Cod. **95** □

**550112**  
STAT ONE LAPPATO RETTIFICATO 15x60  
Cod. **111** □

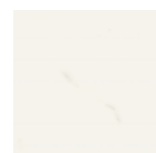

**230262**  
STAT ONE NATURALE  
RETTIFICATO 15x15  
Cod. **78** □



**041044**  
STAT ONE NATURALE  
RETTIFICATO 7,5x15  
Cod. **95** □

IMBALLI • PACKAGES • EMBALLAGES • FORMATE

	SCATOLA • BOX • BOITE • KARTON			PALLET • PALLETS • PALETTS • PALETTE		
	pz	mq	kg	box	mq	kg
<b>120x120</b>	2	2,88	68,80	18	51,84	1.238,00
<b>60x120</b>	2	1,44	30,10	30	43,20	903,00
<b>30x120</b>	3	1,08	22,60	42	45,36	904,00
<b>60x60</b>	3	1,08	22,60	40	43,20	904,00
<b>30x60</b>	6	1,08	22,60	40	43,20	904,00
<b>15x60</b>	10	0,90	18,80	48	43,20	902,00
<b>30x30</b>	11	0,99	20,70	46	45,54	952,00
<b>10x30</b>	20	0,60	12,90	60	36,00	774,00
<b>15x15</b>	46	1,04	22,00	33	34,15	726,00
<b>7,5x15</b>	50	0,56	12,70	76	42,56	965,00

**230263**  
STAT ONE LAPPATO  
RETTIFICATO 15x15  
Cod. **90** □

**041045**  
STAT ONE LAPPATO  
RETTIFICATO 7,5x15  
Cod. **111** □



**606176**  
STAT ONE NATURALE RETTIFICATO 60x60  
Cod. **79** □

**606177**  
STAT ONE LAPPATO RETTIFICATO 60x60  
Cod. **93** □

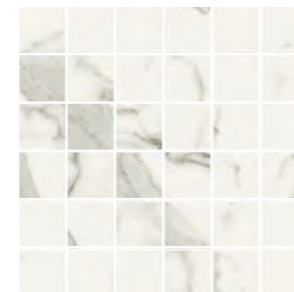

**041046**  
STAT ONE NATURALE  
MOSAICO 5x5 SU RETE 30x30  
Cod. **24** ○

**041047**  
STAT ONE LAPPATO  
MOSAICO 5x5 SU RETE 30x30  
Cod. **31** ○



**041048**  
STAT ONE NATURALE  
MURETTO 2,4x10  
SU RETE 30x30  
Cod. **46** ○

**041049**  
STAT ONE LAPPATO  
MURETTO 2,4x10  
SU RETE 30x30  
Cod. **58** ○



**490570**  
STAT ONE NATURALE RETTIFICATO 30x60  
Cod. **76** □

**490571**  
STAT ONE LAPPATO RETTIFICATO 30x60  
Cod. **85** □



**041050**  
STAT ONE NATURALE MOSAICO  
ESAGONO SU RETE 27x28  
Cod. **136** ○

**041051**  
STAT ONE LAPPATO MOSAICO  
ESAGONO SU RETE 27x28  
Cod. **49** ○

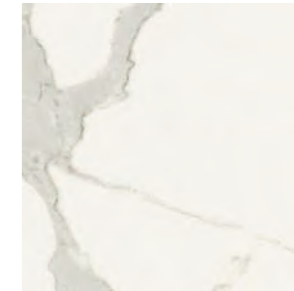

**041042**  
STAT ONE NATURALE RETTIFICATO 30x30  
Cod. **78** □

**041043**  
STAT ONE LAPPATO RETTIFICATO 30x30  
Cod. **90** □



**103090**  
STAT ONE NATURALE RETTIFICATO 10x30  
Cod. **77** □

**103091**  
STAT ONE LAPPATO RETTIFICATO 10x30  
Cod. **93** □



**380248**  
STAT ONE NATURALE  
LISTELLO INLAY 5x30  
Cod. **10** ○

**380249**  
STAT ONE LAPPATO  
LISTELLO INLAY 5x30  
Cod. **11** ○



**380250**  
STAT ONE NATURALE  
LONDON 5x30  
Cod. **33** ○

**380251**  
STAT ONE LUCIDO  
LONDON 5x30  
Cod. **33** ○

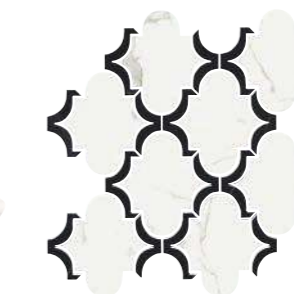

**041179**  
STAT ONE NATURALE MOSAICO  
ARABESQUE SU RETE 30x30  
Cod. **57** ○

**041180**  
STAT ONE LAPPATO MOSAICO  
ARABESQUE SU RETE 30x30  
Cod. **72** ○

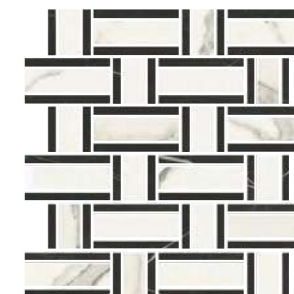

**041052**  
STAT ONE NATURALE MOSAICO  
INLAY SU RETE 30x30  
Cod. **63** ○

**041053**  
STAT ONE LAPPATO MOSAICO  
INLAY SU RETE 30x30  
Cod. **71** ○



## STAT-ONE RETT. LAPPATO

La finitura lappata è consigliata per uso rivestimento o per pavimenti da bagno in ambito residenziale. Nello specifico il tipo di pavimentazione deve essere non soggetta ad eccessive sollecitazioni e mai a diretto contatto con aree esterne. Come si verifica comunemente nelle pietre naturali l'eventuale presenza di puntini sulla superficie o di qualche disuniformità della lucentezza sono da considerare caratteristiche del prodotto derivanti dalla lavorazione a cui viene sottoposto.









The polished finish is recommended for wall coverings or for the floors of residential bathrooms. Specifically, floor coverings in this material must not be subjected to excessively heavy traffic and must never be in direct contact with outdoor areas. As is often the case with natural stones, any spots on the surface or any unevenness in shine are typical characteristics of the product, deriving from the process used.

La finitura polie est recommandée pour le revêtement sol et mur des salles de bains résidentielles. Notamment, ce type de carreau au sol ne doit pas être exposé à des contraintes excessives, et il ne doit jamais être en contact direct avec des zones extérieures. Comme cela est souvent le cas pour les pierres naturelles, les micro trous éventuellement présents à la surface du produit ou l'hétérogénéité de son éclat forment des caractéristiques propres au façonnage.

Die polierte Oberfläche wird für Wandverkleidungen und Bodenbeläge in Privatbädern empfohlen. Der Bodenbelag darf keinen starken Beanspruchungen ausgesetzt sein und keinen direkten Kontakt zu Außenbereichen haben. Wie bei Natursteinen üblich, kann die Oberfläche Körnungen oder einen unregelmäßigen Glanz aufweisen. Diese Merkmale sind typische, beabsichtigte Produkteigenschaften, die durch das Bearbeitungsverfahren hervorgerufen werden.

Pezzi speciali • Special trims • Pièces spéciales • Formstücke

Battiscopa	44 22,40 kg	18 17,10 kg
	<b>290670</b> STAT ONE BATTISCOPA NATURALE 7x30 Cod. <b>116</b> △	
	<b>290671</b> STAT ONE BATTISCOPA LAPPATO 7x30 Cod. <b>22</b> △	<b>290737</b> STAT ONE BATTISCOPA NATURALE 7x60 Cod. <b>121</b> △
		<b>290738</b> STAT ONE BATTISCOPA LAPPATO 7x60 Cod. <b>26</b> △

CARATTERISTICHE DI QUALITÀ Quality characteristics Caractéristiques de qualité Qualitätseigenschaften	NORMA Norm Norme Norme	REQUISITO NORMA Required standards Valeur prescrite selon la norme Normvorgabe	RISULTATO Result Résultat Ergebniss
 Assorbimento d'acqua Water absorption of the body Absorption d'eau de support Wasseraufnahme des Scherbens	ISO 10545-3	≤ 0,5	Conforme Conformity Conforme Gemäss
 Resistenza a flessione Breaking strength Résistance à la flexion Biegefestigkeit	ISO 10545-4	≥ 35 N/mm <sup>2</sup>	Conforme Conformity Conforme Gemäss
 Resistenza all'abrasione Abrasion resistance Résistance à l'abrasion Abriebbeständigkeit	EN ISO 10545-7	Stat One Ret.	PEI IV
 Resistenza al gelo Frost resistance Résistance au gel Frostbeständigkeit	ISO 10545-12	Nessun campione deve presentare rotture o alterazioni apprezzabili alla superficie No samples must show ruptures or noticeable surface alteration Aucuns enchantions doit présenter ruptures ou altérations appréciables de la surface Keines der Muster sollte Risse oder sichtbare Fehler der Oberfläche zeigen	Conforme Conformity Conforme Gemäss
 Resistenza all'attacco chimico Chemical resistance Résistance à l'attaque chimique Beständigkeit gegen chemikalien	ISO 10545-13	Stat One Rettificato Stat One Lappato	GA GLA GA GLB
 Resistenza agli sbalzi termici Thermal shock resistance Résistance aux écarts de température Temperaturwechselbeständigkeit	ISO 10545-5		Conforme Conformity Conforme Gemäss
 Resistenza scivolosità Sliding resistance Résistance au glissement Rutschfestigkeit	DIN 51130 R	Stat One Rettificato	R9
 Significativa variazione Significant variation Variation important Bedeutsam Abweichung		Stat One Rettificato	V3

 Aspetto uniforme  
Uniform appearance  
Aspect uniforme  
Einheitliches Aussehen  
**V1**

 Lieve variazione  
Slight variation  
Légère variation  
Geringe Abweichung  
**V2**

 Significativa variazione  
Significant variation  
Variation important  
Bedeutsam Abweichung  
**V3**

 Forte stonizzazione  
Substantial variation  
Effet dénuancé très accentué  
Akzentuierte Variation  
**V4**

**PER UNA POSA OTTIMALE DEL PRODOTTO CONSIGLIAMO SEMPRE DI MESCOLARE ALMENO TRE SCATOLE DI MATERIALE.**

For the best product laying results, material from at least three boxes should be mixed.

Pour une pose excellente, nous recommandons toujours de mélanger le contenu d'au moins trois boîtes.

Für eine optimale Verlegung des Erzeugnisses empfehlen wir stets, mindestens drei Packungen Material anzumischen.



Tipologia  
Type  
Typologie  
Typ  
Gres porcellanato smaltato  
Glazed porcelain  
Grès cérame emaille  
Feinsteinzeug glasiert

Formati R10  
Sizes  
Formats  
Formate  
60x120  
60x60  
30x60  
15x60  
10x60  
7,5x60  
5x60

Formati R11  
Sizes  
Formats  
Formate  
60x60  
30x60

Spessore  
Thickness  
Épaisseur  
Stärke  
10 mm  
20 mm

Resistenza scivolosità  
Sliding resistance  
Résistance au glissement  
Rutschfestigkeit  
R10 / A+B  
R11 (60x60 - 30x60) / A+B+C

Grado di variazione cromatica  
Degree of colour change  
Degré de variation chromatique  
Grad der Farbabweichung  
V2



**601285**  
STONE SELECTION DARK CLOUD RETTIFICATO 60x120  
Cod. **94** □



**606236**  
STONE SELECTION DARK CLOUD RETTIFICATO 60x60  
Cod. **79** □

**606242**  
STONE SELECTION DARK CLOUD RETTIFICATO R11 60x60  
Cod. **83** □



**490715**  
STONE SELECTION DARK CLOUD RETTIFICATO 30x60  
Cod. **76** □

**490719**  
STONE SELECTION DARK CLOUD RETTIFICATO R11 30x60  
Cod. **77** □



**550121**  
STONE SELECTION DARK CLOUD RETTIFICATO 15x60  
Cod. **82** □



**700017**  
STONE SELECTION DARK CLOUD RETTIFICATO 7,5x60  
Cod. **85** □



**506006**  
STONE SELECTION DARK CLOUD RETTIFICATO 5x60  
Cod. **90** □



**103130**  
STONE SELECTION DARK CLOUD RETTIFICATO 10x30  
Cod. **77** □

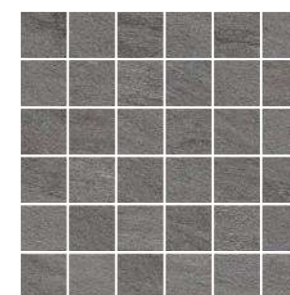

10,90 kg

**041310**  
STONE SELECTION DARK CLOUD  
MOSAICO 5x5 SU RETE 30x30  
Cod. **24** ○



10,90 kg

**041314**  
STONE SELECTION DARK CLOUD  
MOSAICO FRAME 2,5x7,5  
SU RETE 30x30  
Cod. **24** ○



10,90 kg

**041366**  
STONE SELECTION DARK CLOUD  
MOSAICO TEXTURE 2,5x7,5  
SU RETE 30x30  
Cod. **36** ○

IMBALLI • PACKAGES • EMBALLAGES • FORMATE

	SCATOLA • BOX • BOITE • KARTON			PALLET • PALLETS • PALETTS • PALETTE		
	pz	m <sup>q</sup>	kg	box	m <sup>q</sup>	kg
<b>60x120</b>	2	1,44	30,00	32	46,08	985,00
<b>60x60</b>	3	1,08	22,80	40	43,20	935,00
<b>30x60</b>	6	1,08	22,90	40	43,20	940,00
<b>15x60</b>	10	0,90	18,33	48	43,20	905,00
<b>10x60</b>	12	0,72	16,00	60	43,20	985,00
<b>7,5x60</b>	18	0,81	15,20	64	51,84	995,00
<b>5x60</b>	24	0,72	14,50	60	43,20	930,00





**601286**  
STONE SELECTION DOLMEN WHITE RETTIFICATO 60x120  
Cod. **94** □



**606237**  
STONE SELECTION DOLMEN WHITE RETTIFICATO 60x60  
Cod. **79** □

**606243**  
STONE SELECTION DOLMEN WHITE RETTIFICATO R11 60x60  
Cod. **83** □



**490716**  
STONE SELECTION DOLMEN WHITE RETTIFICATO 30x60  
Cod. **76** □

**490720**  
STONE SELECTION DOLMEN WHITE RETTIFICATO R11 30x60  
Cod. **77** □



**550122**  
STONE SELECTION DOLMEN WHITE RETTIFICATO 15x60  
Cod. **82** □



**700018**  
STONE SELECTION DOLMEN WHITE RETTIFICATO 7,5x60  
Cod. **85** □



**506007**  
STONE SELECTION DOLMEN WHITE RETTIFICATO 5x60  
Cod. **90** □



**103131**  
STONE SELECTION DOLMEN WHITE RETTIFICATO 10x30  
Cod. **77** □



**041311**  
STONE SELECTION DOLMEN WHITE  
MOSAICO 5x5 SU RETE 30x30  
Cod. **24** ○



10,90 kg



**041315**  
STONE SELECTION DOLMEN WHITE  
MOSAICO FRAME 2,5x7,5  
SU RETE 30x30  
Cod. **24** ○



10,90 kg



**041367**  
STONE SELECTION DOLMEN WHITE  
MOSAICO TEXTURE 2,5x7,5  
SU RETE 30x30  
Cod. **36** ○



10,90 kg

IMBALLI • PACKAGES • EMBALLAGES • FORMATE

	SCATOLA • BOX • BOITE • KARTON			PALLET • PALLETS • PALETTS • PALETTE		
	<i>pz</i>	<i>mq</i>	<i>kg</i>	<i>box</i>	<i>mq</i>	<i>kg</i>
<b>60x120</b>	2	1,44	30,00	32	46,08	985,00
<b>60x60</b>	3	1,08	22,80	40	43,20	935,00
<b>30x60</b>	6	1,08	22,90	40	43,20	940,00
<b>15x60</b>	10	0,90	18,33	48	43,20	905,00
<b>10x60</b>	12	0,72	16,00	60	43,20	985,00
<b>7,5x60</b>	18	0,81	15,20	64	51,84	995,00
<b>5x60</b>	24	0,72	14,50	60	43,20	930,00



**601284**  
STONE SELECTION NEW GREY RETTIFICATO 60x120  
Cod. **94** □



**606235**  
STONE SELECTION NEW GREY RETTIFICATO 60x60  
Cod. **79** □

**606241**  
STONE SELECTION NEW GREY RETTIFICATO **R11** 60x60  
Cod. **83** □



**490714**  
STONE SELECTION NEW GREY RETTIFICATO 30x60  
Cod. **76** □

**490718**  
STONE SELECTION NEW GREY RETTIFICATO **R11** 30x60  
Cod. **77** □



**550120**  
STONE SELECTION NEW GREY RETTIFICATO 15x60  
Cod. **82** □



**700016**  
STONE SELECTION NEW GREY RETTIFICATO 7,5x60  
Cod. **85** □



**506005**  
STONE SELECTION NEW GREY RETTIFICATO 5x60  
Cod. **90** □



**103129**  
STONE SELECTION NEW GREY RETTIFICATO 10x30  
Cod. **77** □



6  
10,90 kg

**041309**  
STONE SELECTION NEW GREY  
MOSAICO 5x5 SU RETE 30x30  
Cod. **24** ○



6  
10,90 kg

**041313**  
STONE SELECTION NEW GREY  
MOSAICO FRAME 2,5x7,5  
SU RETE 30x30  
Cod. **24** ○



6  
10,90 kg

**041365**  
STONE SELECTION NEW GREY  
MOSAICO TEXTURE 2,5x7,5  
SU RETE 30x30  
Cod. **36** ○

IMBALLI • PACKAGES • EMBALLAGES • FORMATE

	SCATOLA • BOX • BOITE • KARTON			PALLET • PALLETS • PALETTS • PALETTE		
	pz	m <sup>q</sup>	kg	box	m <sup>q</sup>	kg
<b>60x120</b>	2	1,44	30,00	32	46,08	985,00
<b>60x60</b>	3	1,08	22,80	40	43,20	935,00
<b>30x60</b>	6	1,08	22,90	40	43,20	940,00
<b>15x60</b>	10	0,90	18,33	48	43,20	905,00
<b>10x60</b>	12	0,72	16,00	60	43,20	985,00
<b>7,5x60</b>	18	0,81	15,20	64	51,84	995,00
<b>5x60</b>	24	0,72	14,50	60	43,20	930,00



**601287**  
STONE SELECTION MOON CREAM RETTIFICATO 60x120  
Cod. **94** □



**606238**  
STONE SELECTION MOON CREAM RETTIFICATO 60x60  
Cod. **79** □

**606244**  
STONE SELECTION MOON CREAM RETTIFICATO **R11** 60x60  
Cod. **83** □



**490717**  
STONE SELECTION MOON CREAM RETTIFICATO 30x60  
Cod. **76** □

**490721**  
STONE SELECTION MOON CREAM RETTIFICATO **R11** 30x60  
Cod. **77** □



**550123**  
STONE SELECTION MOON CREAM RETTIFICATO 15x60  
Cod. **82** □



**700019**  
STONE SELECTION MOON CREAM RETTIFICATO 7,5x60  
Cod. **85** □



**506008**  
STONE SELECTION MOON CREAM RETTIFICATO 5x60  
Cod. **90** □



**103132**  
STONE SELECTION MOON CREAM RETTIFICATO 10x30  
Cod. **77** □



10,90 kg

**041312**  
STONE SELECTION MOON CREAM  
MOSAICO 5x5 SU RETE 30x30  
Cod. **24** ○



10,90 kg

**041316**  
STONE SELECTION MOON CREAM  
MOSAICO FRAME 2,5x7,5  
SU RETE 30x30  
Cod. **24** ○



10,90 kg

**041368**  
STONE SELECTION MOON CREAM  
MOSAICO TEXTURE 2,5x7,5  
SU RETE 30x30  
Cod. **36** ○

IMBALLI • PACKAGES • EMBALLAGES • FORMATE

	SCATOLA • BOX • BOITE • KARTON			PALLET • PALLETS • PALETTS • PALETTE		
	pz	m <sup>q</sup>	kg	box	m <sup>q</sup>	kg
<b>60x120</b>	2	1,44	30,00	32	46,08	985,00
<b>60x60</b>	3	1,08	22,80	40	43,20	935,00
<b>30x60</b>	6	1,08	22,90	40	43,20	940,00
<b>15x60</b>	10	0,90	18,33	48	43,20	905,00
<b>10x60</b>	12	0,72	16,00	60	43,20	985,00
<b>7,5x60</b>	18	0,81	15,20	64	51,84	995,00
<b>5x60</b>	24	0,72	14,50	60	43,20	930,00



601289  
STONE SELECTION DARK CLOUD 2 CM RETTIFICATO 60x120  
Cod. 141 □

± 20 mm



601291  
STONE SELECTION MOON CREAM 2 CM RETTIFICATO 60x120  
Cod. 141 □

± 20 mm



IMBALLI • PACKAGES • EMBALLAGES • FORMATE

	SCATOLA • BOX • BOITE • KARTON			PALLET • PALLETS • PALETTS • PALETTE		
	<i>pz</i>	<i>mq</i>	<i>kg</i>	<i>box</i>	<i>mq</i>	<i>kg</i>
60x120 (20mm)	1	0,72	30,60	36	25,92	1.125,00

Pezzi speciali • Special trims • Pièces spéciales • Formstücke

## Battiscopa



13,20 kg

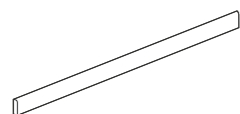

**290792**  
STONE SELECTION DARK CLOUD  
BATTISCOPA 5x60  
Cod. **121** △

**290793**  
STONE SELECTION DOLMEN WHITE  
BATTISCOPA 5x60  
Cod. **121** △

**290791**  
STONE SELECTION NEW GREY  
BATTISCOPA 5x60  
Cod. **121** △

**290794**  
STONE SELECTION MOON CREAM  
BATTISCOPA 5x60  
Cod. **121** △

## Gradino



29,40 kg

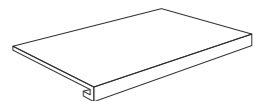

**490745**  
STONE SELECTION DARK CLOUD  
GRADINO 33x60  
Cod. **112** ○

**490746**  
STONE SELECTION DOLMEN WHITE  
GRADINO 33x60  
Cod. **112** ○

**490744**  
STONE SELECTION NEW GREY  
GRADINO 33x60  
Cod. **112** ○

**490747**  
STONE SELECTION MOON CREAM  
GRADINO 33x60  
Cod. **112** ○

## Angolare



10,00 kg

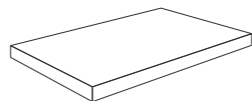

**490749**  
STONE SELECTION DARK CLOUD  
ANGOLARE 33x60  
Cod. **107** ○

**490750**  
STONE SELECTION DOLMEN WHITE  
ANGOLARE 33x60  
Cod. **107** ○

**490748**  
STONE SELECTION NEW GREY  
ANGOLARE 33x60  
Cod. **107** ○

**490751**  
STONE SELECTION MOON CREAM  
ANGOLARE 33x60  
Cod. **107** ○



17,28 kg

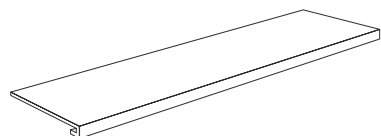

**490753**  
STONE SELECTION DARK CLOUD  
GRADINO 33x120  
Cod. **114** ○

**490754**  
STONE SELECTION DOLMEN WHITE  
GRADINO 33x120  
Cod. **114** ○

**490752**  
STONE SELECTION NEW GREY  
GRADINO 33x120  
Cod. **114** ○

**490755**  
STONE SELECTION MOON CREAM  
GRADINO 33x120  
Cod. **114** ○

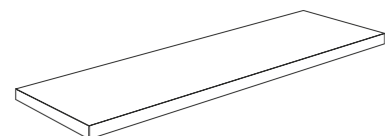

**490757**  
STONE SELECTION DARK CLOUD  
ANGOLARE 33x120  
Cod. **110** ○

**490758**  
STONE SELECTION DOLMEN WHITE  
ANGOLARE 33x120  
Cod. **110** ○

**490756**  
STONE SELECTION NEW GREY  
ANGOLARE 33x120  
Cod. **110** ○

**490759**  
STONE SELECTION MOON CREAM  
ANGOLARE 33x120  
Cod. **110** ○

CARATTERISTICHE DI QUALITÀ Quality characteristics Caractéristiques de qualité Qualitätseigenschaften	NORMA Norm Norme Norme	REQUISITO NORMA Required standards Valeur prescrite selon la norme Normvorgabe	RISULTATO Result Résultat Ergebniss
Assorbimento d'acqua Water absorption of the body Absorption d'eau de support Wasseraufnahme des Scherbens	ISO 10545-3	≤ 0,5	Conforme Conformity Conforme Gemäss
Resistenza a flessione Breaking strenght Résistance à la flexion Biegefestigkeit	ISO 10545-4	≥ 35 N/mm <sup>2</sup>	Conforme Conformity Conforme Gemäss
Resistenza all'abrasione Abrasion resistance Resistance a l'abrasion Abriebbeständigkeit	EN ISO 10545-7		PEI V
Resistenza al gelo Frost resistance Résistance au gel Frostbeständigkeit	ISO 10545-12	Nessun campione deve presentare rotture o alterazioni apprezzabili alla superficie No samples must show ruptures or noticeable surface alteration Aucuns enchantions doit présenter ruptures ou altérations appréciables de la surface Keines der Muster sollte Risse oder sichtbare Fehler der Oberfläche zeigen	Conforme Conformity Conforme Gemäss
Resistenza all'attacco chimico Chemical resistance Résistance à l'attaque chimique Beständigkeit gegen chemikalien	ISO 10545-13		GA GLA
Resistenza agli sbalzi termici Thermal shock resistance Resistance aux écarts de température Temperaturwechselbeständigkeit	ISO 10545-5		Conforme Conformity Conforme Gemäss
Resistenza scivolosità Sliding resistance Resistance au glissement Rutschfestigkeit	DIN 51130 R	Versione 10 mm 60x60cm - 30x60 R11   60x120 20mm	R10 R11 (60x60 - 30x60)
Resistenza scivolosità Sliding resistance Resistance au glissement Rutschfestigkeit	DIN 51097 (A+B+C)	Versione 10 mm 60x60cm - 30x60 R11   60x120 20mm	A+B A+B+C
Coefficiente d'attrito dinamico Wet dynamic coefficient of friction Coefficient de friction dynamique Reibungskoeffizient Schlupfrigkeit (in Bewegung)	Bot 3000 E	DCOF ≥ 0,42	> 0,42
Lieve variazione Slight variation Légère variation Geringe Abweichung			V2

**V1**  
Aspetto uniforme  
Uniform appearance  
Aspect uniforme  
Einheitliches Aussehen

**V2**  
Lieve variazione  
Slight variation  
Légère variation  
Geringe Abweichung

**V3**  
Significativa variazione  
Significant variation  
Variation important  
Bedeutsam Abweichung

**V4**  
Forte stonalizzazione  
Substantial variation  
Effet dénuancé très accentué  
Akzentuierte Variation

**PER UNA POSA OTTIMALE DEL PRODOTTO CONSIGLIAMO SEMPRE DI MESCOLARE ALMENO TRE SCATOLE DI MATERIALE.**  
For the best product laying results, material from at least three boxes should be mixed.  
Pour une pose excellente, nous recommandons toujours de mélanger le contenu d'au moins trois boîtes.  
Für eine optimale Verlegung des Erzeugnisses empfehlen wir stets, mindestens drei Packungen Material anzumischen.



Tipologia  
Type  
Typologie  
Typ  
Gres porcellanato smaltato  
Glazed porcelain  
Grès cérame emaille  
Feinsteinzeug glasiert

Formati  
Sizes  
Formats  
Formate  
60x120  
60x60  
30x60  
30x30  
10x30

Spessore  
Thickness  
Épaisseur  
Stärke  
9 mm

Resistenza scivolosità  
Sliding resistance  
Resistance au glissement  
Rutschfestigkeit  
R9

Grado di variazione cromatica  
Degree of colour change  
Degré de variation chromatique  
Grad der Farbabweichung  
V3



**601276**  
STYLISH TAUPE NATURALE  
RETTIFICATO 60x120  
Cod. **94** □

**601277**  
STYLISH TAUPE LAPPATO  
RETTIFICATO 60x120  
Cod. **103** □



**606221**  
STYLISH TAUPE NATURALE  
RETTIFICATO 60x60  
Cod. **79** □

**606222**  
STYLISH TAUPE LAPPATO  
RETTIFICATO 60x60  
Cod. **93** □



**490685**  
STYLISH TAUPE NATURALE  
RETTIFICATO 30x60  
Cod. **76** □

**490686**  
STYLISH TAUPE LAPPATO  
RETTIFICATO 30x60  
Cod. **85** □

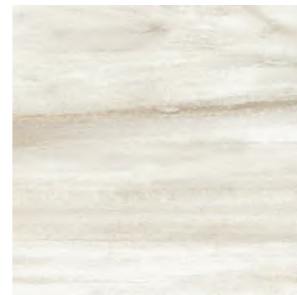

**041151**  
STYLISH TAUPE NATURALE RETTIFICATO 30x30  
Cod. **78** □

**041152**  
STYLISH TAUPE LAPPATO RETTIFICATO 30x30  
Cod. **90** □



**103117**  
STYLISH TAUPE NATURALE  
RETTIFICATO 10x30  
Cod. **77** □

**103118**  
STYLISH TAUPE LAPPATO  
RETTIFICATO 10x30  
Cod. **93** □



**041236**  
STYLISH TAUPE NATURALE  
MOSAICO 5x5 SU RETE 30x30  
Cod. **24** ○

**041237**  
STYLISH TAUPE LAPPATO  
MOSAICO 5x5 SU RETE 30x30  
Cod. **31** ○

6  
9,30 kg



**041238**  
STYLISH TAUPE NATURALE  
MOSAICO ESAGONO SU RETE 27x28  
Cod. **136** ○

**041239**  
STYLISH TAUPE LAPPATO  
MOSAICO ESAGONO SU RETE 27x28  
Cod. **49** ○

6  
8,90 kg



**041226**  
STYLISH TAUPE NATURALE  
MOSAICO HB SU RETE 28x32  
Cod. **45** ○

**041227**  
STYLISH TAUPE LAPPATO  
MOSAICO HB SU RETE 28x32  
Cod. **48** ○

6  
10,20 kg



**041220**  
STYLISH TAUPE NATURALE  
MOSAICO ESAGONO INTARSIO SU RETE 20,7x27  
Cod. **57** ○

**041221**  
STYLISH TAUPE LAPPATO  
MOSAICO ESAGONO INTARSIO SU RETE 20,7x27  
Cod. **72** ○

6  
6,50 kg



**380297**  
STYLISH TAUPE NATURALE  
BORDURA MURETTO 7x30  
Cod. **28** ○

**380298**  
STYLISH TAUPE LAPPATO  
BORDURA MURETTO 7x30  
Cod. **28** ○

10  
3,60 kg



**380291**  
STYLISH TAUPE NATURALE  
LONDON 5x30  
Cod. **33** ○

**380292**  
STYLISH TAUPE LUCIDO  
LONDON 5x30  
Cod. **33** ○

24  
6,11 kg

**IMBALLI • PACKAGES • EMBALLAGES • FORMATE**

	SCATOLA • BOX • BOITE • KARTON			PALLET • PALLETS • PALETTS • PALETTE		
	pz	mq	kg	box	mq	kg
<b>60x120</b>	2	1,44	30,20	30	43,20	906,00
<b>60x60</b>	3	1,08	22,60	40	43,20	904,00
<b>30x60</b>	6	1,08	22,60	40	43,20	904,00
<b>30x30</b>	11	0,99	21,20	46	45,54	975,00
<b>10x30</b>	20	0,60	12,90	60	36,00	774,00



## stylish taupe RETT. LAPPATO

La finitura lappata è consigliata per uso rivestimento o per pavimenti da bagno in ambito residenziale. Nello specifico il tipo di pavimentazione deve essere non soggetta ad eccessive sollecitazioni e mai a diretto contatto con aree esterne. Come si verifica comunemente nelle pietre naturali l'eventuale presenza di puntini sulla superficie o di qualche disuniformità della lucentezza sono da considerare caratteristiche del prodotto derivanti dalla lavorazione a cui viene sottoposto.

The polished finish is recommended for wall coverings or for the floors of residential bathrooms. Specifically, floor coverings in this material must not be subjected to excessively heavy traffic and must never be in direct contact with outdoor areas. As is often the case with natural stones, any spots on the surface or any unevenness in shine are typical characteristics of the product, deriving from the process used.

La finitura polie est recommandée pour le revêtement sol et mur des salles de bains résidentielles. Notamment, ce type de carreau au sol ne doit pas être exposé à des contraintes excessives, et il ne doit jamais être en contact direct avec des zones extérieures. Comme cela est souvent le cas pour les pierres naturelles, les micro trous éventuellement présents à la surface du produit ou l'hétérogénéité de son éclat forment des caractéristiques propres au façonnage.

Die polierte Oberfläche wird für Wandverkleidungen und Bodenbeläge in Privatbädern empfohlen. Der Bodenbelag darf keinen starken Beanspruchungen ausgesetzt sein und keinen direkten Kontakt zu Außenbereichen haben. Wie bei Natursteinen üblich, kann die Oberfläche Körnungen oder einen unregelmäßigen Glanz aufweisen. Diese Merkmale sind typische, beabsichtigte Produkteigenschaften, die durch das Bearbeitungsverfahren hervorgerufen werden.

Pezzi speciali • Special trims • Pièces spéciales • Formstücke

Battiscopa



22,40 kg



17,10 kg

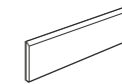

**290760**  
STYLISH TAUPE NATURALE  
BATTISCOPA 7x30  
Cod. **116** △

**290761**  
STYLISH TAUPE LAPPATO  
BATTISCOPA 7x30  
Cod. **22** △

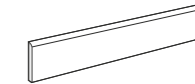

**290766**  
STYLISH TAUPE NATURALE  
BATTISCOPA 7x60  
Cod. **121** △

**290767**  
STYLISH TAUPE LAPPATO  
BATTISCOPA 7x60  
Cod. **26** △

	CARATTERISTICHE DI QUALITÀ QUALITY CHARACTERISTICS CARACTÉRISTIQUES DE QUALITÉ QUALITÄTSEIGENSCHAFTEN	NORMA NORM NORME NORME	REQUISITO NORMA REQUIRED STANDARDS VALEUR PRESCRITE SELON LA NORME NORMVORGABE	RISULTATO RESULT RÉSULTAT ERGEBNISS
	Assorbimento d'acqua Water absorption of the body Absorption d'eau de support Wasseraufnahme des Scherbens	ISO 10545-3	≤ 0,5	Conforme Conformity Conforme Gemäss
	Resistenza a flessione Breaking strenght Résistance à la flexion Biegefestigkeit	ISO 10545-4	≥ 35 N/mm <sup>2</sup>	Conforme Conformity Conforme Gemäss
	Resistenza all'abrasione Abrasion resistance Résistance à l'abrasion Abriebbeständigkeit	ISO 10545-7	Stylish Taupe Rettificato	PEI IV
	Resistenza al gelo Frost resistance Résistance au gel Frostbeständigkeit	ISO 10545-12	Nessun campione deve presentare rotture o alterazioni apprezzabili alla superficie No samples must show ruptures or noticeable surface alteration Aucuns enchantions doit présenter ruptures ou altérations appréciables de la surface Keines der Muster sollte Risse oder sichtbare Fehler der Oberfläche zeigen	Conforme Conformity Conforme Gemäss
	Resistenza all'attacco chimico Chemical resistance Résistance à l'attaque chimique Beständigkeit gegen chemikalien	ISO 10545-13	Stylish Taupe Naturale Stylish Taupe Lappato	GA GLA GA GLB
	Resistenza agli sbalzi termici Thermal shock resistance Résistance aux écarts de température Temperaturwechselbeständigkeit	ISO 10545-5		Conforme Conformity Conforme Gemäss
	Resistenza scivolosità Sliding resistance Résistance au glissement Rutschfestigkeit	DIN 51130 R		R9
	Significativa variazione Significant variation Variation important Bedeutsam Abweichung		Stylish Taupe Rettificato	V3

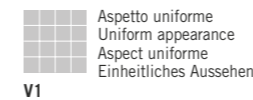

V1



V2

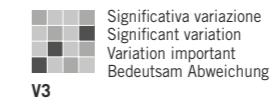

V3

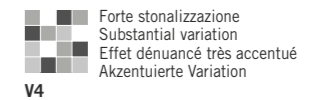

V4

**PER UNA POSA OTTIMALE DEL PRODOTTO CONSIGLIAMO SEMPRE DI MESCOLARE ALMENO TRE SCATOLE DI MATERIALE.**

For the best product laying results, material from at least three boxes should be mixed.

Pour une pose excellente, nous recommandons toujours de mélanger le contenu d'au moins trois boîtes.

Für eine optimale Verlegung des Erzeugnisses empfehlen wir stets, mindestens drei Packungen Material anzumischen.





Tipologia  
Type  
Typologie  
Typ  
Gres porcellanato smaltato  
Glazed porcelain  
Grès cérame emaille  
Feinsteinzeug glasiert

Formati  
Sizes  
Formats  
Formate  
30x60  
30x30  
10x30  
25x22 Esagona

Spessore  
Thickness  
Épaisseur  
Stärke  
10 mm

Resistenza scivolosità  
Sliding resistance  
Resistance au glissement  
Rutschfestigkeit  
R10

Grado di variazione cromatica  
Degree of colour change  
Degré de variation chromatique  
Grad der Farbabweichung  
V1

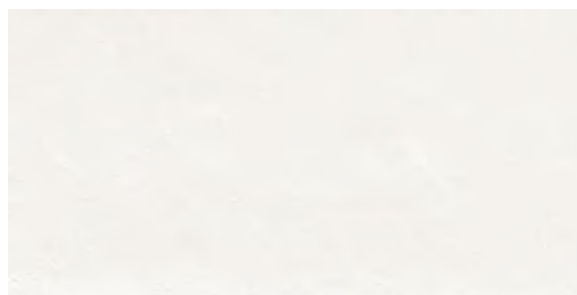

**490867**  
TINTEUNITE WHITE RETTIFICATO 30x60  
Cod. **76** □



**041487**  
TINTEUNITE WHITE  
MOSAICO 5x5 SU RETE 30x30  
Cod. **24** ○



**490868**  
TINTEUNITE GREY RETTIFICATO 30x60  
Cod. **76** □



**041488**  
TINTEUNITE GREY  
MOSAICO 5x5 SU RETE 30x30  
Cod. **24** ○



**041490**  
TINTEUNITE WHITE RETTIFICATO 30x30  
Cod. **78** □



**041484**  
TINTEUNITE WHITE  
MOSAICO ESAGONO SU RETE 30x26  
Cod. **136** ○



**041491**  
TINTEUNITE GREY RETTIFICATO 30x30  
Cod. **78** □



**041485**  
TINTEUNITE GREY  
MOSAICO ESAGONO SU RETE 30x26  
Cod. **136** ○



**103161**  
TINTEUNITE WHITE RETTIFICATO 10x30  
Cod. **77** □

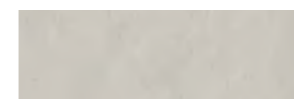

**103162**  
TINTEUNITE GREY RETTIFICATO 10x30  
Cod. **77** □



**252223**  
TINTEUNITE WHITE HEX MATT  
25x22 ESAGONA  
Cod. **85** □



**252224**  
TINTEUNITE GREY HEX MATT  
25x22 ESAGONA  
Cod. **85** □

**IMBALLI • PACKAGES • EMBALLAGES • FORMATE**

	SCATOLA • BOX • BOITE • KARTON			PALLET • PALLETS • PALETTS • PALETTE		
	<i>pz</i>	<i>mq</i>	<i>kg</i>	<i>box</i>	<i>mq</i>	<i>kg</i>
<b>30x60</b>	6	1,08	23,99	40	43,20	960,00
<b>30x30</b>	11	0,99	23,20	46	45,54	1.090,00
<b>10x30</b>	20	0,60	14,00	60	36,00	870,00
<b>25x22 Esagona</b>	9	0,37	8,50	72	26,64	640,00

**IMBALLI • PACKAGES • EMBALLAGES • FORMATE**

	SCATOLA • BOX • BOITE • KARTON			PALLET • PALLETS • PALETTS • PALETTE		
	<i>pz</i>	<i>mq</i>	<i>kg</i>	<i>box</i>	<i>mq</i>	<i>kg</i>
<b>30x60</b>	6	1,08	23,99	40	43,20	960,00
<b>30x30</b>	11	0,99	23,20	46	45,54	1.090,00
<b>10x30</b>	20	0,60	14,00	60	36,00	870,00
<b>25x22 Esagona</b>	9	0,37	8,50	72	26,64	640,00

Pezzi speciali • Special trims • Pièces spéciales • Formstücke

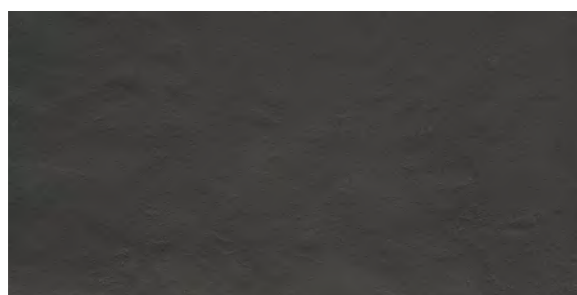

**490866**  
TINTEUNITE BLACK RETTIFICATO 30x60  
Cod. **76** □

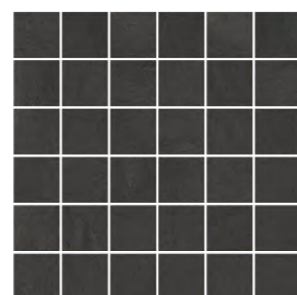

**041486**  
TINTEUNITE BLACK  
MOSAICO 5x5 SU RETE 30x30  
Cod. **24** ○

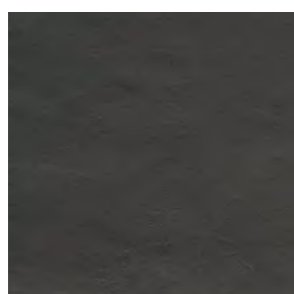

**041489**  
TINTEUNITE BLACK RETTIFICATO 30x30  
Cod. **78** □



**041483**  
TINTEUNITE BLACK  
MOSAICO ESAGONO SU RETE 30x26  
Cod. **136** ○



**103160**  
TINTEUNITE BLACK RETTIFICATO 10x30  
Cod. **77** □



**252222**  
TINTEUNITE BLACK HEX MATT  
25x22 ESAGONA  
Cod. **85** □

IMBALLI • PACKAGES • EMBALLAGES • FORMATE

	SCATOLA • BOX • BOITE • KARTON			PALLET • PALLETS • PALETTS • PALETTE		
	pz	m <sub>q</sub>	kg	box	m <sub>q</sub>	kg
<b>30x60</b>	6	1,08	23,99	40	43,20	960,00
<b>30x30</b>	11	0,99	23,20	46	45,54	1.090,00
<b>10x30</b>	20	0,60	14,00	60	36,00	870,00
<b>25x22 Esagona</b>	9	0,37	8,50	72	26,64	640,00

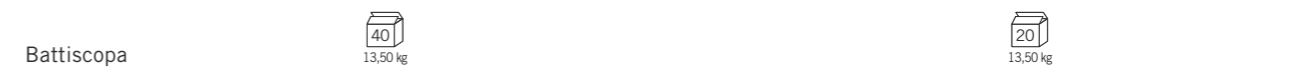

Battiscopa

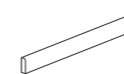

**290913**  
TINTEUNITE WHITE  
BATTISCOPA 5x30  
Cod. **116** △

**290914**  
TINTEUNITE GREY  
BATTISCOPA 5x30  
Cod. **116** △

**290912**  
TINTEUNITE BLACK  
BATTISCOPA 5x30  
Cod. **116** △

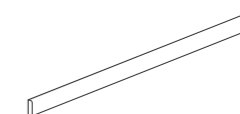

**290878**  
TINTEUNITE WHITE  
BATTISCOPA 5x60  
Cod. **121** △

**290879**  
TINTEUNITE GREY  
BATTISCOPA 5x60  
Cod. **121** △

**290877**  
TINTEUNITE BLACK  
BATTISCOPA 5x60  
Cod. **121** △

	CARATTERISTICHE DI QUALITÀ Quality characteristics Caractéristiques de qualité Qualitätseigenschaften	NORMA Norm Norme Norme	REQUISITO NORMA Required standards Valeur prescrite selon la norme Normvorgabe	RISULTATO Result Résultat Ergebniss
	Assorbimento d'acqua Water absorption of the body Absorption d'eau de support Wasseraufnahme des Scherbens	ISO 10545-3	≤ 0,5	Conforme Conformity Conforme Gemäss
	Resistenza a flessione Breaking strength Résistance à la flexion Biegefestigkeit	ISO 10545-4	≥ 35 N/mm <sup>2</sup>	Conforme Conformity Conforme Gemäss
	Resistenza all'abrasione Abrasion resistance Résistance à l'abrasion Abriebbeständigkeit	EN ISO 10545-7	White - Grey  Black	PEI IV  PEI III
	Resistenza al gelo Frost resistance Résistance au gel Frostbeständigkeit	ISO 10545-12	Nessun campione deve presentare rotture o alterazioni apprezzabili alla superficie No samples must show ruptures or noticeable surface alteration Aucuns enchantions doit présenter ruptures ou altérations appréciables de la surface Keines der Muster sollte Risse oder sichtbare Fehler der Oberfläche zeigen	Conforme Conformity Conforme Gemäss
	Resistenza all'attacco chimico Chemical resistance Résistance à l'attaque chimique Beständigkeit gegen chemikalien	ISO 10545-13	Nessun campione deve presentare rotture o alterazioni apprezzabili alla superficie No samples must show ruptures or noticeable surface alteration Aucuns enchantions doit présenter ruptures ou altérations appréciables de la surface Keines der Muster sollte Risse oder sichtbare Fehler der Oberfläche zeigen	
	Resistenza agli sbalzi termici Thermal shock resistance Résistance aux écarts de température Temperaturwechselbeständigkeit	ISO 10545-5		Conforme Conformity Conforme Gemäss
	Resistenza scivolosità Sliding resistance Résistance au glissement Rutschfestigkeit	DIN 51130 R		R10
	Coefficiente d'attrito dinamico Wet dynamic coefficient of friction Coefficient de friction dynamique Reibungskoeffizient Schlupfrigkeit (in Bewegung)	Bot 3000 E	DCOF ≥ 0,42	> 0,42
	Aspetto uniforme Uniform appearance Aspect uniforme Einheitliches Aussehen			V1

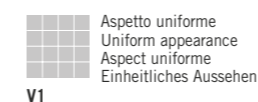

V1



V2



V3

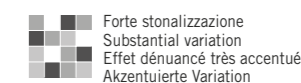

V4

**PER UNA POSA OTTIMALE DEL PRODOTTO CONSIGLIAMO SEMPRE DI MESCOLARE ALMENO TRE SCATOLE DI MATERIALE.**

For the best product laying results, material from at least three boxes should be mixed.  
Pour une pose excellente, nous recommandons toujours de mélanger le contenu d'au moins trois boîtes.  
Für eine optimale Verlegung des Erzeugnisses empfehlen wir stets, mindestens drei Packungen Material anzumischen.



Tipologia  
Type  
Typologie  
Typ  
Gres porcellanato smaltato  
Glazed porcelain  
Grès cérame émaille  
Feinsteinzeug glasiert

Formati  
Sizes  
Formats  
Formate  
60x120  
60x60  
30x60  
10x30

Spessore  
Thickness  
Épaisseur  
Stärke  
9 mm

Resistenza scivolosità  
Sliding resistance  
Resistance au glissement  
Rutschfestigkeit  
R9

Grado di variazione cromatica  
Degree of colour change  
Degré de variation chromatique  
Grad der Farbabweichung  
V3



**601345**  
TROPICAL BREEZE NATURALE  
RETTIFICATO 60x120  
Cod. **94** □

**601346**  
TROPICAL BREEZE LAPPATO  
RETTIFICATO 60x120  
Cod. **103** □

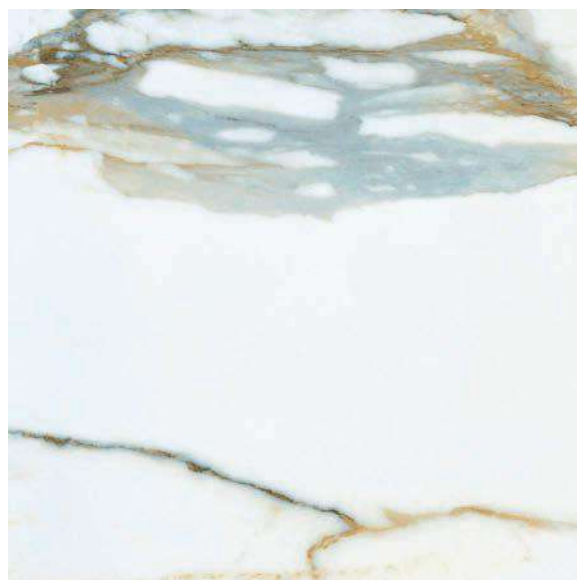

**606300**  
TROPICAL BREEZE NATURALE  
RETTIFICATO 60x60  
Cod. **79** □

**606301**  
TROPICAL BREEZE LAPPATO  
RETTIFICATO 60x60  
Cod. **93** □



**490877**  
TROPICAL BREEZE NATURALE  
RETTIFICATO 30x60  
Cod. **76** □

**490878**  
TROPICAL BREEZE LAPPATO  
RETTIFICATO 30x60  
Cod. **85** □



**103171**  
TROPICAL BREEZE NATURALE  
RETTIFICATO 10x30  
Cod. **77** □

**103172**  
TROPICAL BREEZE LAPPATO  
RETTIFICATO 10x30  
Cod. **93** □



6  
9,30 kg

**041628**  
TROPICAL BREEZE NATURALE  
MOSAICO 5x5 SU RETE 30x30  
Cod. **24** ○

**041635**  
TROPICAL BREEZE LAPPATO  
MOSAICO 5x5 SU RETE 30x30  
Cod. **31** ○



6  
8,90 kg

**041551**  
TROPICAL BREEZE NATURALE  
MOSAICO ESAGONO SU RETE 27x28  
Cod. **136** ○

**041552**  
TROPICAL BREEZE LAPPATO  
MOSAICO ESAGONO SU RETE 27x28  
Cod. **49** ○



6  
10,20 kg

**041519**  
TROPICAL BREEZE NATURALE  
MOSAICO HB SU RETE 28x32  
Cod. **45** ○

**041520**  
TROPICAL BREEZE LAPPATO  
MOSAICO HB SU RETE 28x32  
Cod. **48** ○



6  
6,50 kg

**041583**  
TROPICAL BREEZE NATURALE  
MOSAICO ESAGONO INTARSIO SU RETE 20,7x27  
Cod. **57** ○

**041584**  
TROPICAL BREEZE LAPPATO  
MOSAICO ESAGONO INTARSIO SU RETE 20,7x27  
Cod. **72** ○



6  
8,90 kg

**041567**  
TROPICAL BREEZE NATURALE  
MOSAICO FANCY SU RETE 24x30  
Cod. **51** ○

**041568**  
TROPICAL BREEZE LAPPATO  
MOSAICO FANCY SU RETE 24x30  
Cod. **71** ○

**IMBALLI • PACKAGES • EMBALLAGES • FORMATE**

	SCATOLA • BOX • BOITE • KARTON			PALLET • PALLETS • PALETTS • PALETTE		
	<i>pz</i>	<i>mq</i>	<i>kg</i>	<i>box</i>	<i>mq</i>	<i>kg</i>
<b>60x120</b>	2	1,44	30,20	30	43,20	906,00
<b>60x60</b>	3	1,08	22,60	40	43,20	904,00
<b>30x60</b>	6	1,08	22,60	40	43,20	975,00
<b>10x30</b>	20	0,60	12,90	60	36,00	774,00



## tropical breeze RETT. LAPPATO

La finitura lappata è consigliata per uso rivestimento o per pavimenti da bagno in ambito residenziale. Nello specifico il tipo di pavimentazione deve essere non soggetta ad eccessive sollecitazioni e mai a diretto contatto con aree esterne. Come si verifica comunemente nelle pietre naturali l'eventuale presenza di puntini sulla superficie o di qualche disuniformità della lucentezza sono da considerare caratteristiche del prodotto derivanti dalla lavorazione a cui viene sottoposto.

The polished finish is recommended for wall coverings or for the floors of residential bathrooms. Specifically, floor coverings in this material must not be subjected to excessively heavy traffic and must never be in direct contact with outdoor areas. As is often the case with natural stones, any spots on the surface or any unevenness in shine are typical characteristics of the product, deriving from the process used.

La finition polie est recommandée pour le revêtement sol et mur des salles de bains résidentielles. Notamment, ce type de carreau au sol ne doit pas être exposé à des contraintes excessives, et il ne doit jamais être en contact direct avec des zones extérieures. Comme cela est souvent le cas pour les pierres naturelles, les micro trous éventuellement présents à la surface du produit ou l'hétérogénéité de son éclat forment des caractéristiques propres au façonnage.

Die polierte Oberfläche wird für Wandverkleidungen und Bodenbeläge in Privatbädern empfohlen. Der Bodenbelag darf keinen starken Beanspruchungen ausgesetzt sein und keinen direkten Kontakt zu Außenbereichen haben. Wie bei Natursteinen üblich, kann die Oberfläche Körnungen oder einen unregelmäßigen Glanz aufweisen. Diese Merkmale sind typische, beabsichtigte Produkteigenschaften, die durch das Bearbeitungsverfahren hervorgerufen werden.

Pezzi speciali • Special trims • Pièces spéciales • Formstücke

Battiscopa	44 22,40 kg	18 17,10 kg
	<b>290888</b> TROPICAL BREEZE NATURALE BATTISCOPA 7x30 Cod. <b>116</b> △	<b>290904</b> TROPICAL BREEZE NATURALE BATTISCOPA 7x60 Cod. <b>121</b> △
	<b>290889</b> TROPICAL BREEZE LAPPATO BATTISCOPA 7x30 Cod. <b>22</b> △	<b>290905</b> TROPICAL BREEZE LAPPATO BATTISCOPA 7x60 Cod. <b>26</b> △

CARATTERISTICHE DI QUALITÀ Quality characteristics Caractéristiques de qualité Qualitätseigenschaften	NORMA Norm Norme Norme	REQUISITO NORMA Required standards Valeur prescrite selon la norme Normvorgabe	RISULTATO Result Résultat Ergebniss
Assorbimento d'acqua Water absorption of the body Absorption d'eau de support Wasseraufnahme des Scherbens	ISO 10545-3	≤ 0,5	Conforme Conformity Conforme Gemäss
Resistenza a flessione Breaking strenght Résistance à la flexion Biegefestigkeit	ISO 10545-4	≥ 35 N/mm <sup>2</sup>	Conforme Conformity Conforme Gemäss
Resistenza all'abrasione Abrasion resistance Résistance à l'abrasion Abriebbeständigkeit	ISO 10545-7	TROPICAL BREEZE Rettificato	PEI IV
Resistenza al gelo Frost resistance Résistance au gel Frostbeständigkeit	ISO 10545-12	Nessun campione deve presentare rotture o alterazioni apprezzabili alla superficie No samples must show ruptures or noticeable surface alteration Aucuns enchantions doit présenter ruptures ou altérations appréciables de la surface Keines der Muster sollte Risse oder sichtbare Fehler der Oberfläche zeigen	Conforme Conformity Conforme Gemäss
Resistenza all'attacco chimico Chemical resistance Résistance à l'attaque chimique Beständigkeit gegen chemikalien	ISO 10545-13	TROPICAL BREEZE Naturale TROPICAL BREEZE Lappato	GA GLA GA GLB
Resistenza agli sbalzi termici Thermal shock resistance Résistance aux écarts de température Temperaturwechselbeständigkeit	ISO 10545-5		Conforme Conformity Conforme Gemäss
Resistenza scivolosità Sliding resistance Résistance au glissement Rutschfestigkeit	DIN 51130 R		R9
Significativa variazione Significant variation Variation important Bedeutsam Abweichung		TROPICAL BREEZE Rettificato	V3

**V1**  
Aspetto uniforme  
Uniform appearance  
Aspect uniforme  
Einheitliches Aussehen

**V2**  
Lieve variazione  
Slight variation  
Légère variation  
Geringe Abweichung

**V3**  
Significativa variazione  
Significant variation  
Variation important  
Bedeutsam Abweichung

**V4**  
Forte stonazione  
Substantial variation  
Effet dénuancé très accentué  
Akzentuierte Variation

**PER UNA POSA OTTIMALE DEL PRODOTTO CONSIGLIAMO SEMPRE DI MESCOLARE ALMENO TRE SCATOLE DI MATERIALE.**

For the best product laying results, material from at least three boxes should be mixed.

Pour une pose excellente, nous recommandons toujours de mélanger le contenu d'au moins trois boîtes.

Für eine optimale Verlegung des Erzeugnisses empfehlen wir stets, mindestens drei Packungen Material anzumischen.



Tipologia  
Type  
Typologie  
Typ  
Gres porcellanato smaltato  
Glazed porcelain  
Grès cérame émaille  
Feinsteinzeug glasiert

Formati  
Sizes  
Formats  
Formate  
120x120  
60x120  
60x60  
30x60  
30x30  
10x30

Spessore  
Thickness  
Épaisseur  
Stärke  
9 mm

Resistenza scivolosità  
Sliding resistance  
Resistance au glissement  
Rutschfestigkeit  
R9

Grado di variazione cromatica  
Degree of colour change  
Degré de variation chromatique  
Grad der Farbabweichung  
V3

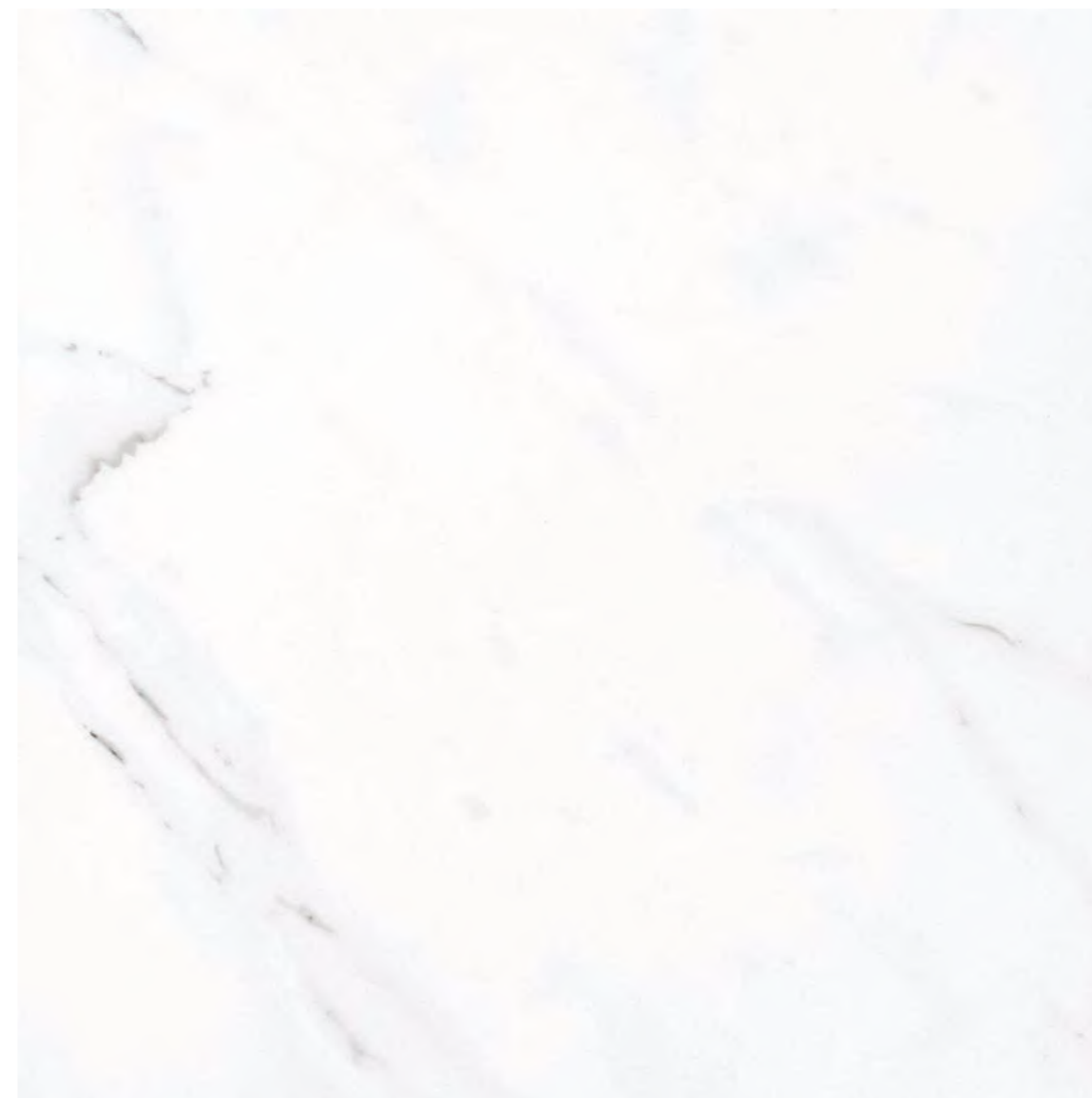

**121201**  
VENATO SELECT NATURALE RETTIFICATO 120x120  
Cod. **100** □

**121202**  
VENATO SELECT LAPPATO RETTIFICATO 120x120  
Cod. **141** □

**IMBALLI • PACKAGES • EMBALLAGES • FORMATE**

	SCATOLA • BOX • BOITE • KARTON			PALLET • PALLETS • PALETTS • PALETTE		
	<i>pz</i>	<i>mq</i>	<i>kg</i>	<i>box</i>	<i>mq</i>	<i>kg</i>
<b>120x120</b>	2	2,88	68,80	18	51,84	1.238,00
<b>60x120</b>	2	1,44	30,10	30	43,20	903,00
<b>60x60</b>	3	1,08	22,60	40	43,20	904,00
<b>30x60</b>	6	1,08	22,60	40	43,20	904,00
<b>30x30</b>	11	0,99	20,70	46	45,54	952,00
<b>10x30</b>	20	0,60	12,90	60	36,00	774,00





**601262**  
VENATO SELECT NATURALE  
RETTIFICATO 60x120  
Cod. **94** □

**601263**  
VENATO SELECT LAPPATO  
RETTIFICATO 60x120  
Cod. **103** □



**606205**  
VENATO SELECT NATURALE  
RETTIFICATO 60x60  
Cod. **79** □

**606206**  
VENATO SELECT LAPPATO  
RETTIFICATO 60x60  
Cod. **93** □



**490604**  
VENATO SELECT NATURALE  
RETTIFICATO 30x60  
Cod. **76** □

**490605**  
VENATO SELECT LAPPATO  
RETTIFICATO 30x60  
Cod. **85** □

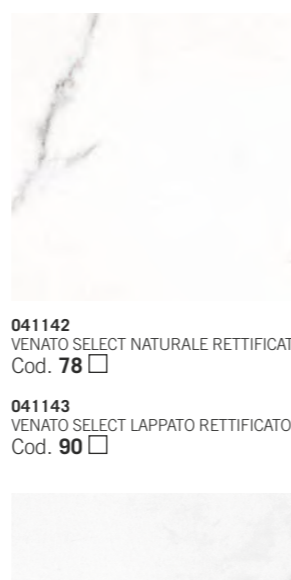

**041142**  
VENATO SELECT NATURALE RETTIFICATO 30x30  
Cod. **78** □

**041143**  
VENATO SELECT LAPPATO RETTIFICATO 30x30  
Cod. **90** □

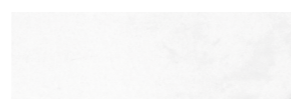

**103104**  
VENATO SELECT NATURALE  
RETTIFICATO 10x30  
Cod. **77** □

**103107**  
VENATO SELECT LAPPATO  
RETTIFICATO 10x30  
Cod. **93** □



6  
9,30 kg

**041144**  
VENATO SELECT NATURALE  
MOSAICO 5x5 SU RETE 30x30  
Cod. **24** ○

**041145**  
VENATO SELECT LAPPATO  
MOSAICO 5x5 SU RETE 30x30  
Cod. **31** ○



6  
9,30 kg

**041149**  
VENATO SELECT NATURALE  
MOSAICO INTARSIO SU RETE 30x30  
Cod. **31** ○

**041150**  
VENATO SELECT LAPPATO  
MOSAICO INTARSIO SU RETE 30x30  
Cod. **35** ○



6  
10,20 kg

**041127**  
VENATO SELECT NATURALE  
MOSAICO HB SU RETE 28x32  
Cod. **45** ○

**041153**  
VENATO SELECT LAPPATO  
MOSAICO HB SU RETE 28x32  
Cod. **48** ○



6  
9,30 kg

**041146**  
VENATO SELECT NATURALE  
MURETTO 2,4x10 SU RETE 30x30  
Cod. **46** ○

**041147**  
VENATO SELECT LAPPATO  
MURETTO 2,4x10 SU RETE 30x30  
Cod. **58** ○



6  
8,90 kg

**041126**  
VENATO SELECT NATURALE  
MOSAICO ESAGONO SU RETE 27x28  
Cod. **136** ○

**041148**  
VENATO SELECT LAPPATO  
MOSAICO ESAGONO SU RETE 27x28  
Cod. **49** ○



6  
9,30 kg

**041183**  
VENATO SELECT NATURALE  
MOSAICO ARABESQUE SU RETE 30x30  
Cod. **57** ○

**041184**  
VENATO SELECT LAPPATO  
MOSAICO ARABESQUE SU RETE 30x30  
Cod. **72** ○



24  
6,11 kg

**380270**  
VENATO SELECT NATURALE  
LONDON 5x30  
Cod. **33** ○

**380271**  
VENATO SELECT LUCIDO  
LONDON 5x30  
Cod. **33** ○



## venato select RETT. LAPPATO

La finitura lappata è consigliata per uso rivestimento o per pavimenti da bagno in ambito residenziale. Nello specifico il tipo di pavimentazione deve essere non soggetta ad eccessive sollecitazioni e mai a diretto contatto con aree esterne. Come si verifica comunemente nelle pietre naturali l'eventuale presenza di puntini sulla superficie o di qualche disuniformità della lucentezza sono da considerare caratteristiche del prodotto derivanti dalla lavorazione a cui viene sottoposto.

The polished finish is recommended for wall coverings or for the floors of residential bathrooms. Specifically, floor coverings in this material must not be subjected to excessively heavy traffic and must never be in direct contact with outdoor areas. As is often the case with natural stones, any spots on the surface or any unevenness in shine are typical characteristics of the product, deriving from the process used.

La finition polie est recommandée pour le revêtement sol et mur des salles de bains résidentielles. Notamment, ce type de carreau au sol ne doit pas être exposé à des contraintes excessives, et il ne doit jamais être en contact direct avec des zones extérieures. Comme cela est souvent le cas pour les pierres naturelles, les micro trous éventuellement présents à la surface du produit ou l'hétérogénéité de son éclat forment des caractéristiques propres au façonnage.

Die polierte Oberfläche wird für Wandverkleidungen und Bodenbeläge in Privatbädern empfohlen. Der Bodenbelag darf keinen starken Beanspruchungen ausgesetzt sein und keinen direkten Kontakt zu Außenbereichen haben. Wie bei Natursteinen üblich, kann die Oberfläche Körnungen oder einen unregelmäßigen Glanz aufweisen. Diese Merkmale sind typische, beabsichtigte Produkteigenschaften, die durch das Bearbeitungsverfahren hervorgerufen werden.

Pezzi speciali • Special trims • Pièces spéciales • Formstücke

Battiscopa



44  
22,40 kg



18  
17,10 kg

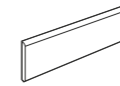

**290713**  
VENATO SELECT NATURALE  
BATTISCOPA 7x30  
Cod. **116** △

**290714**  
VENATO SELECT LAPPATO  
BATTISCOPA 7x30  
Cod. **22** △

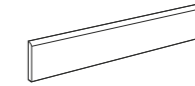

**290741**  
VENATO SELECT NATURALE  
BATTISCOPA 7x60  
Cod. **121** △

**290742**  
VENATO SELECT LAPPATO  
BATTISCOPA 7x60  
Cod. **26** △

CARATTERISTICHE DI QUALITÀ QUALITY CHARACTERISTICS CARACTERISTIQUES DE QUALITÉ QUALITÄTSEIGENSCHAFTEN	NORMA NORM NORME NORME	REQUISITO NORMA REQUIRED STANDARDS VALEUR PRESCRITE SELON LA NORME NORMVORGABE	RISULTATO RESULT RESULTAT ERGEBNISS
Assorbimento d'acqua Water absorption of the body Absorption d'eau de support Wasseraufnahme des Scherbens	ISO 10545-3	≤ 0,5	Conforme Conformity Conforme Gemäss
Resistenza a flessione Breaking strenght Résistance à la flexion Biegefestigkeit	ISO 10545-4	≥ 35 N/mm <sup>2</sup>	Conforme Conformity Conforme Gemäss
Resistenza all'abrasione Abrasion resistance Résistance à l'abrasion Abriebbeständigkeit	ISO 10545-7	Venato Select Rettificato Venato Select Lappato	PEI IV
Resistenza al gelo Frost resistance Résistance au gel Frostbeständigkeit	ISO 10545-12	Nessun campione deve presentare rotture o alterazioni apprezzabili alla superficie No samples must show ruptures or noticeable surface alteration Aucuns enchantions doit présenter ruptures ou altérations appréciables de la surface Keines der Muster sollte Risse oder sichtbare Fehler der Oberfläche zeigen	Conforme Conformity Conforme Gemäss
Resistenza all'attacco chimico Chemical resistance Résistance à l'attaque chimique Beständigkeit gegen chemikalien	ISO 10545-13	Venato Select Rettificato Venato Select Lappato	GA GLA GA GLB
Resistenza agli sbalzi termici Thermal shock resistance Résistance aux écarts de température Temperaturwechselbeständigkeit	ISO 10545-5		Conforme Conformity Conforme Gemäss
Resistenza scivolosità Sliding resistance Résistance au glissement Rutschfestigkeit	DIN 51130 R	Venato Select Rettificato Venato Select Lappato	R9
Significativa variazione Significant variation Variation important Bedeutsam Abweichung			V3

Aspetto uniforme  
Uniform appearance  
Aspect uniforme  
Einheitliches Aussehen

V1

Lieve variazione  
Slight variation  
Légère variation  
Geringe Abweichung

V2

Significativa variazione  
Significant variation  
Variation important  
Bedeutsam Abweichung

V3

Forte stonalizzazione  
Substantial variation  
Effet dénuancé très accentué  
Akzentuierte Variation

V4

**PER UNA POSA OTTIMALE DEL PRODOTTO CONSIGLIAMO SEMPRE DI MESCOLARE ALMENO TRE SCATOLE DI MATERIALE.**

For the best product laying results, material from at least three boxes should be mixed.

Pour une pose excellente, nous recommandons toujours de mélanger le contenu d'au moins trois boîtes.

Für eine optimale Verlegung des Erzeugnisses empfehlen wir stets, mindestens drei Packungen Material anzumischen.



Tipologia  
Type  
Typologie  
Typ  
Gres porcellanato smaltato  
Glazed porcelain  
Grès cérame emaille  
Feinsteinzeug glasiert

Formati  
Sizes  
Formats  
Formate  
60x120  
60x60  
30x60  
10x30

Spessore  
Thickness  
Épaisseur  
Stärke  
9 mm

Resistenza scivolosità  
Sliding resistance  
Resistance au glissement  
Rutschfestigkeit  
R9

Grado di variazione cromatica  
Degree of colour change  
Degré de variation chromatique  
Grad der Farbabweichung  
V3



**0601322**  
VENICE BLACK  
RETTIFICATO 60x120  
Cod. **94** □

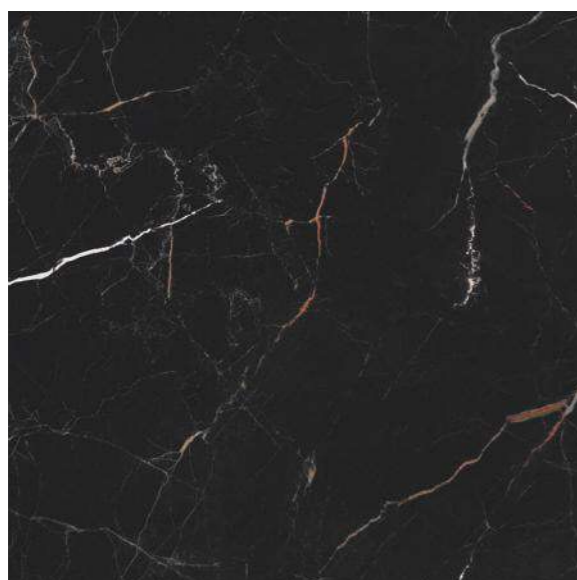

**0606268**  
VENICE BLACK  
RETTIFICATO 60x60  
Cod. **87** □

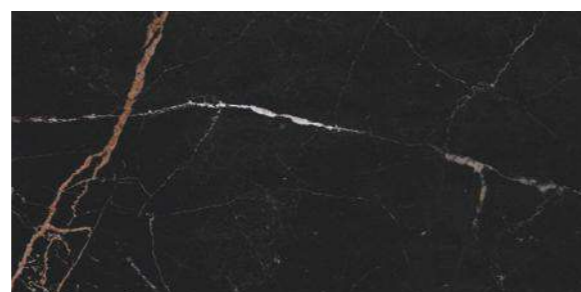

**0490819**  
VENICE BLACK  
RETTIFICATO 30x60  
Cod. **79** □



**0103149**  
VENICE BLACK  
RETTIFICATO 10x30  
Cod. **87** □

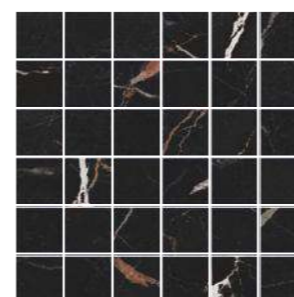

9,70 kg

**0041421**  
VENICE BLACK  
MOSAICO 5x5 SU RETE 30x30  
Cod. **26** ○

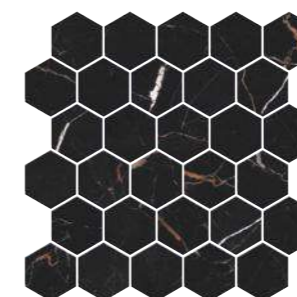

8,90 kg

**0041429**  
VENICE BLACK  
MOSAICO ESAGONO SU RETE 27x28  
Cod. **45** ○



9,80 kg

**0041437**  
VENICE BLACK  
MOSAICO HB SU RETE 28x32  
Cod. **46** ○

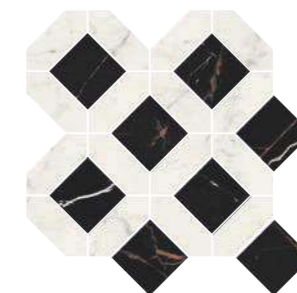

9,80 kg

**0041445**  
VENICE BLACK  
MOSAICO ANTIQUE LUX SU RETE 30x30  
Cod. **69** ○

IMBALLI • PACKAGES • EMBALLAGES • FORMATE

	SCATOLA • BOX • BOITE • KARTON			PALLET • PALLETS • PALETTS • PALETTE		
	<i>pz</i>	<i>mq</i>	<i>kg</i>	<i>box</i>	<i>mq</i>	<i>kg</i>
<b>60x120</b>	2	1,44	28,70	30	43,20	861,00
<b>60x60</b>	3	1,08	21,50	40	43,20	861,00
<b>30x60</b>	6	1,08	21,50	40	43,20	861,00
<b>10x30</b>	20	0,60	11,40	60	36,00	684,00

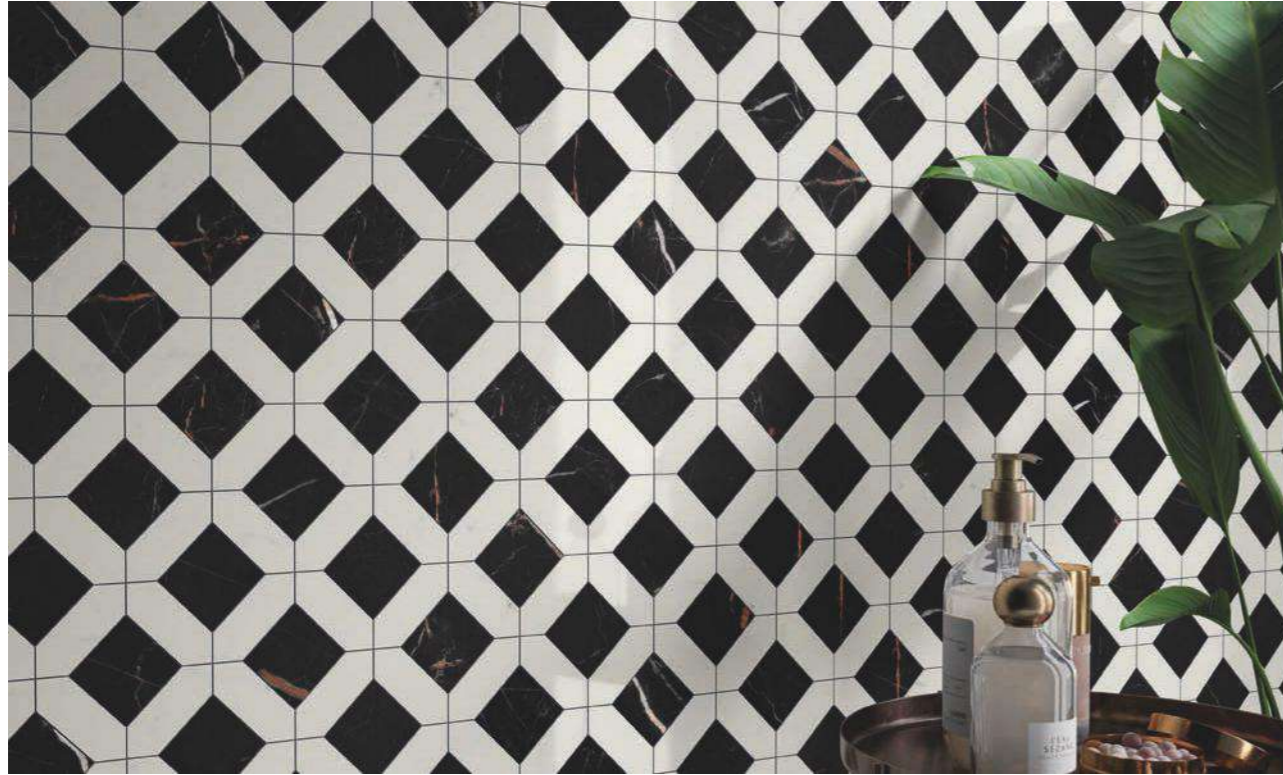

Pezzi speciali • Special trims • Pièces spéciales • Formstücke

Battiscopa

44  
17,20 kg

18  
14,80 kg

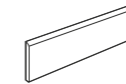

0290837  
VENICE BLACK  
BATTISCOPA 7x30  
Cod. 19 △

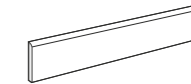

0290845  
VENICE BLACK  
BATTISCOPA 7x60  
Cod. 23 △

CARATTERISTICHE DI QUALITÀ Quality characteristics Caractéristiques de qualité Qualitätseigenschaften	NORMA Norm Norme Norme	REQUISITO NORMA Required standards Valeur prescrite selon la norme Normvorgabe	RISULTATO Result Résultat Ergebniss
Assorbimento d'acqua Water absorption of the body Absorption d'eau de support Wasseraufnahme des Scherbens	ISO 10545-3	≤ 0,5	Conforme Conformity Conforme Gemäss
Resistenza a flessione Breaking strenght Résistance à la flexion Biegefestigkeit	ISO 10545-4	≥ 35 N/mm <sup>2</sup>	Conforme Conformity Conforme Gemäss
Resistenza all'abrasione Abrasion resistance Resistance a l'abrasion Abriebbeständigkeit	ISO 10545-7	≤ 175 mm <sup>3</sup>	Conforme Conformity Conforme Gemäss
Resistenza al gelo Frost resistance Résistance au gel Frostbeständigkeit	ISO 10545-12	Nessun campione deve presentare rotture o alterazioni apprezzabili alla superficie No samples must show ruptures or noticeable surface alteration Aucuns enchantions doit présenter ruptures ou altérations appréciables de la surface Keines der Muster sollte Risse oder sichtbare Fehler der Oberfläche zeigen	Conforme Conformity Conforme Gemäss
Resistenza all'attacco chimico Chemical resistance Résistance à l'attaque chimique Beständigkeit gegen chemikalien	ISO 10545-13		GA GLA
Resistenza agli sbalzi termici Thermal shock resistance Resistance aux écarts de température Temperaturwechselbeständigkeit	ISO 10545-5		Conforme Conformity Conforme Gemäss
Resistenza scivolosità Sliding resistance Resistance au glissement Rutschfestigkeit	DIN 51130 R		R9
Coefficiente d'attrito dinamico Wet dynamic coefficient of friction Coefficient de friction dynamique Reibungskoeffizient Schlupfrigkeit (in Bewegung)	Bot 3000 E	DCOF ≥ 0,42	> 0,42
Significativa variazione Significant variation Variation important Bedeutsam Abweichung			V3

Aspetto uniforme  
Uniform appearance  
Aspect uniforme  
Einheitliches Aussehen  
V1

Lieve variazione  
Slight variation  
Légère variation  
Geringe Abweichung  
V2

Significativa variazione  
Significant variation  
Variation important  
Bedeutsam Abweichung  
V3

Forte tonalizzazione  
Substantial variation  
Effet dénuancé très accentué  
Akzentuierte Variation  
V4

**PER UNA POSA OTTIMALE DEL PRODOTTO CONSIGLIAMO SEMPRE DI MESCOLARE ALMENO TRE SCATOLE DI MATERIALE.**

For the best product laying results, material from at least three boxes should be mixed.

Pour une pose excellente, nous recommandons toujours de mélanger le contenu d'au moins trois boîtes.

Für eine optimale Verlegung des Erzeugnisses empfehlen wir stets, mindestens drei Packungen Material anzumischen.



Tipologia  
Type  
Typologie  
Typ  
Gres porcellanato smaltato  
Glazed porcelain  
Grès cérame emaille  
Feinsteinzeug glasiert

Formati  
Sizes  
Formats  
Formate  
60x120  
60x60  
30x60  
10x30

Spessore  
Thickness  
Épaisseur  
Stärke  
9 mm

Resistenza scivolosità  
Sliding resistance  
Resistance au glissement  
Rutschfestigkeit  
R9

Grado di variazione cromatica  
Degree of colour change  
Degré de variation chromatique  
Grad der Farbabweichung  
V3

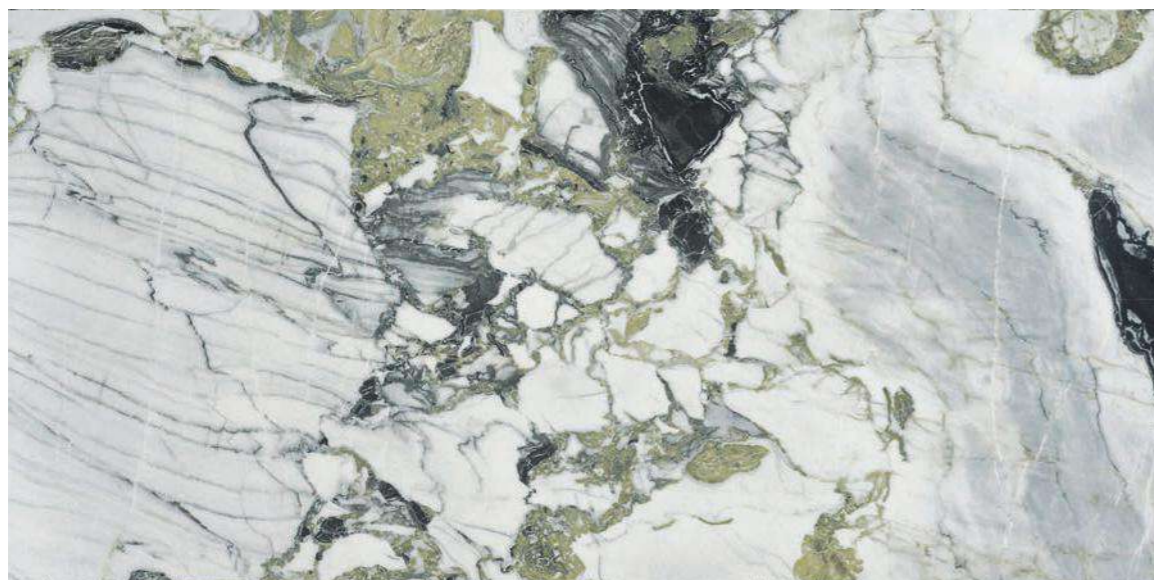

**601349**  
WHITE BEAUTY NATURALE  
RETTIFICATO 60x120  
Cod. **94** □

**601350**  
WHITE BEAUTY LAPPATO  
RETTIFICATO 60x120  
Cod. **103** □



**606304**  
WHITE BEAUTY NATURALE  
RETTIFICATO 60x60  
Cod. **79** □

**606305**  
WHITE BEAUTY LAPPATO  
RETTIFICATO 60x60  
Cod. **93** □



**490881**  
WHITE BEAUTY NATURALE  
RETTIFICATO 30x60  
Cod. **76** □

**490882**  
WHITE BEAUTY LAPPATO  
RETTIFICATO 30x60  
Cod. **85** □



**103175**  
WHITE BEAUTY NATURALE  
RETTIFICATO 10x30  
Cod. **77** □

**103176**  
WHITE BEAUTY LAPPATO  
RETTIFICATO 10x30  
Cod. **93** □

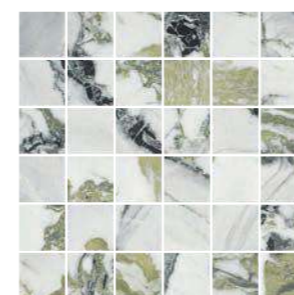

6  
9,30 kg

**041638**  
WHITE BEAUTY NATURALE  
MOSAICO 5x5 SU RETE 30x30  
Cod. **24** ○

**041639**  
WHITE BEAUTY LAPPATO  
MOSAICO 5x5 SU RETE 30x30  
Cod. **31** ○

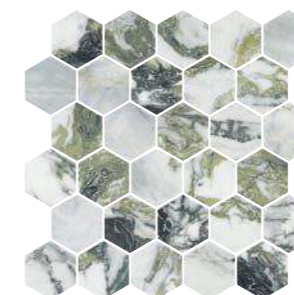

6  
8,90 kg

**041555**  
WHITE BEAUTY NATURALE  
MOSAICO ESAGONO SU RETE 27x28  
Cod. **136** ○

**041556**  
WHITE BEAUTY LAPPATO  
MOSAICO ESAGONO SU RETE 27x28  
Cod. **49** ○



6  
10,20 kg

**041523**  
WHITE BEAUTY NATURALE  
MOSAICO HB SU RETE 28x32  
Cod. **45** ○

**041524**  
WHITE BEAUTY LAPPATO  
MOSAICO HB SU RETE 28x32  
Cod. **48** ○



6  
6,50 kg

**041587**  
WHITE BEAUTY NATURALE  
MOSAICO ESAGONO INTARSIO SU RETE 20,7x27  
Cod. **57** ○

**041588**  
WHITE BEAUTY LAPPATO  
MOSAICO ESAGONO INTARSIO SU RETE 20,7x27  
Cod. **72** ○



6  
8,90 kg

**041571**  
WHITE BEAUTY NATURALE  
MOSAICO FANCY SU RETE 24x30  
Cod. **51** ○

**041572**  
WHITE BEAUTY LAPPATO  
MOSAICO FANCY SU RETE 24x30  
Cod. **71** ○

IMBALLI • PACKAGES • EMBALLAGES • FORMATE

	SCATOLA • BOX • BOITE • KARTON			PALLET • PALLETS • PALETTS • PALETTE		
	pz	mq	kg	box	mq	kg
<b>60x120</b>	2	1,44	30,20	30	43,20	906,00
<b>60x60</b>	3	1,08	22,60	40	43,20	904,00
<b>30x60</b>	6	1,08	22,60	40	43,20	975,00
<b>10x30</b>	20	0,60	12,90	60	36,00	774,00



## white beauty RETT. LAPPATO

La finitura lappata è consigliata per uso rivestimento o per pavimenti da bagno in ambito residenziale. Nello specifico il tipo di pavimentazione deve essere non soggetta ad eccessive sollecitazioni e mai a diretto contatto con aree esterne. Come si verifica comunemente nelle pietre naturali l'eventuale presenza di puntini sulla superficie o di qualche disuniformità della lucentezza sono da considerare caratteristiche del prodotto derivanti dalla lavorazione a cui viene sottoposto.

The polished finish is recommended for wall coverings or for the floors of residential bathrooms. Specifically, floor coverings in this material must not be subjected to excessively heavy traffic and must never be in direct contact with outdoor areas. As is often the case with natural stones, any spots on the surface or any unevenness in shine are typical characteristics of the product, deriving from the process used.

La finitura polie est recommandée pour le revêtement sol et mur des salles de bains résidentielles. Notamment, ce type de carreau au sol ne doit pas être exposé à des contraintes excessives, et il ne doit jamais être en contact direct avec des zones extérieures. Comme cela est souvent le cas pour les pierres naturelles, les micro trous éventuellement présents à la surface du produit ou l'hétérogénéité de son éclat forment des caractéristiques propres au façonnage.

Die polierte Oberfläche wird für Wandverkleidungen und Bodenbeläge in Privatbädern empfohlen. Der Bodenbelag darf keinen starken Beanspruchungen ausgesetzt sein und keinen direkten Kontakt zu Außenbereichen haben. Wie bei Natursteinen üblich, kann die Oberfläche Körnungen oder einen unregelmäßigen Glanz aufweisen. Diese Merkmale sind typische, beabsichtigte Produkteigenschaften, die durch das Bearbeitungsverfahren hervorgerufen werden.

Pezzi speciali • Special trims • Pièces spéciales • Formstücke

Battiscopa

44  
17,20 kg

18  
14,80 kg

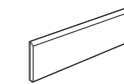

**290892**  
WHITE BEAUTY NATURALE  
BATTISCOPA 7x30  
Cod. **116** △

**290893**  
WHITE BEAUTY LAPPATO  
BATTISCOPA 7x30  
Cod. **22** △

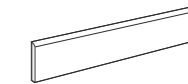

**290908**  
WHITE BEAUTY NATURALE  
BATTISCOPA 7x60  
Cod. **121** △

**290909**  
WHITE BEAUTY LAPPATO  
BATTISCOPA 7x60  
Cod. **26** △

CARATTERISTICHE DI QUALITÀ Quality characteristics Caractéristiques de qualité Qualitätseigenschaften	NORMA Norm Norme Norme	REQUISITO NORMA Required standards Valeur prescrite selon la norme Normvorgabe	RISULTATO Result Résultat Ergebniss
Assorbimento d'acqua Water absorption of the body Absorption d'eau de support Wasseraufnahme des Scherbens	ISO 10545-3	≤ 0,5	Conforme Conformity Conforme Gemäss
Resistenza a flessione Breaking strenght Résistance à la flexion Biegefestigkeit	ISO 10545-4	≥ 35 N/mm <sup>2</sup>	Conforme Conformity Conforme Gemäss
Resistenza all'abrasione Abrasion resistance Résistance à l'abrasion Abriebbeständigkeit	ISO 10545-7	WHITE BEAUTY Rettificato	PEI IV
Resistenza al gelo Frost resistance Résistance au gel Frostbeständigkeit	ISO 10545-12	Nessun campione deve presentare rotture o alterazioni apprezzabili alla superficie No samples must show ruptures or noticeable surface alteration Aucuns enchantions doit présenter ruptures ou altérations appréciables de la surface Keines der Muster sollte Risse oder sichtbare Fehler der Oberfläche zeigen	Conforme Conformity Conforme Gemäss
Resistenza all'attacco chimico Chemical resistance Résistance à l'attaque chimique Beständigkeit gegen chemikalien	ISO 10545-13	WHITE BEAUTY Naturale WHITE BEAUTY Lappato	GA GLA GA GLB
Resistenza agli sbalzi termici Thermal shock resistance Résistance aux écarts de température Temperaturwechselbeständigkeit	ISO 10545-5		Conforme Conformity Conforme Gemäss
Resistenza scivolosità Sliding resistance Résistance au glissement Rutschfestigkeit	DIN 51130 R		R9
Significativa variazione Significant variation Variation important Bedeutsam Abweichung		WHITE BEAUTY Rettificato	V3

Aspetto uniforme  
Uniform appearance  
Aspect uniforme  
Einheitliches Aussehen  
**V1**

Lieve variazione  
Slight variation  
Légère variation  
Geringe Abweichung  
**V2**

Significativa variazione  
Significant variation  
Variation important  
Bedeutsam Abweichung  
**V3**

Forte stonalizzazione  
Substantial variation  
Effet dénuancé très accentué  
Akzentuierte Variation  
**V4**

**PER UNA POSA OTTIMALE DEL PRODOTTO CONSIGLIAMO SEMPRE DI MESCOLARE ALMENO TRE SCATOLE DI MATERIALE.**

For the best product laying results, material from at least three boxes should be mixed.

Pour une pose excellente, nous recommandons toujours de mélanger le contenu d'au moins trois boîtes.

Für eine optimale Verlegung des Erzeugnisses empfehlen wir stets, mindestens drei Packungen Material anzumischen.





Tipologia  
Type  
Typologie  
Typ  
Gres porcellanato smaltato  
Glazed porcelain  
Grès cérame emaille  
Feinsteinzeug glasiert

Formati  
Sizes  
Formats  
Formate  
120x120  
60x120  
30x120  
60x60  
30x60  
15x60  
30x30  
10x30  
15x15

Spessore  
Thickness  
Épaisseur  
Stärke  
9 mm

Resistenza scivolosità  
Sliding resistance  
Resistance au glissement  
Rutschfestigkeit  
R9

Grado di variazione cromatica  
Degree of colour change  
Degré de variation chromatique  
Grad der Farbabweichung  
V2

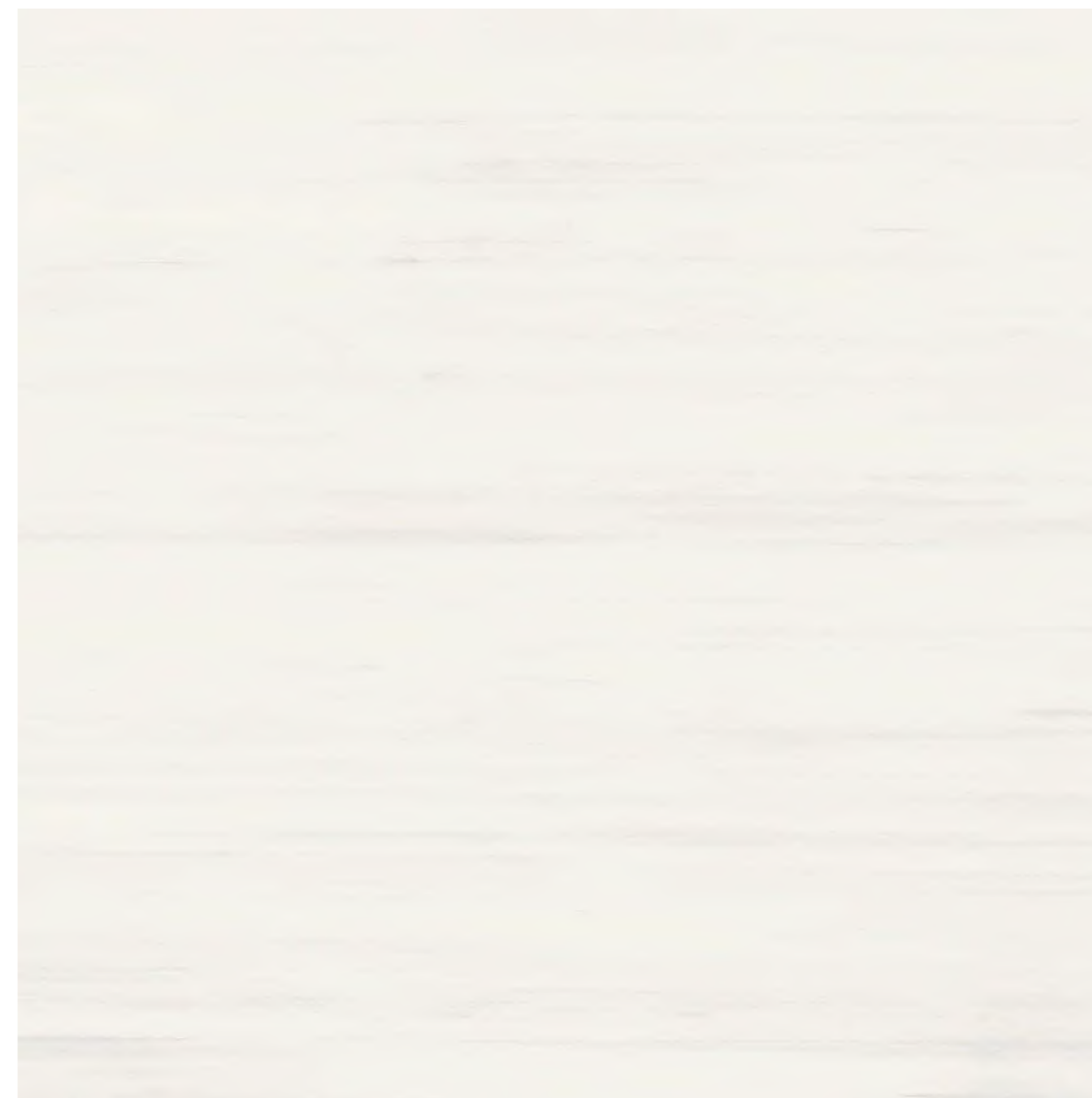

**121203**  
WHITE DOLOMITE NATURALE RETTIFICATO 120x120  
Cod. **100** □

**121204**  
WHITE DOLOMITE LAPPATO RETTIFICATO 120x120  
Cod. **141** □



**601245**  
WHITE DOLOMITE NATURALE  
RETTIFICATO 60x120  
Cod. **94** □

**601246**  
WHITE DOLOMITE LAPPATO  
RETTIFICATO 60x120  
Cod. **103** □

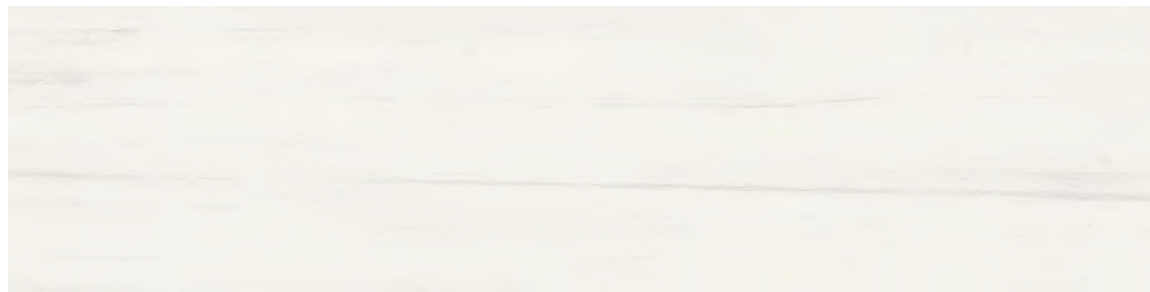

**301240**  
WHITE DOLOMITE NATURALE  
RETTIFICATO 30x120  
Cod. **99** □

**301241**  
WHITE DOLOMITE LAPPATO  
RETTIFICATO 30x120  
Cod. **106** □



**550109**  
WHITE DOLOMITE NATURALE  
RETTIFICATO 15x60  
Cod. **95** □

**550110**  
WHITE DOLOMITE LAPPATO  
RETTIFICATO 15x60  
Cod. **111** □



**230260**  
WHITE DOLOMITE NATURALE  
RETTIFICATO 15x15  
Cod. **78** □

**230261**  
WHITE DOLOMITE LAPPATO  
RETTIFICATO 15x15  
Cod. **90** □

**IMBALLI • PACKAGES • EMBALLAGES • FORMATE**

	SCATOLA • BOX • BOITE • KARTON			PALLET • PALLETS • PALETTS • PALETTE		
	pz	mq	kg	box	mq	kg
<b>120x120</b>	2	2,88	68,80	18	51,84	1.238,00
<b>60x120</b>	2	1,44	30,10	30	43,20	903,00
<b>30x120</b>	3	1,08	22,60	42	45,36	904,00
<b>60x60</b>	3	1,08	22,60	40	43,20	904,00
<b>30x60</b>	6	1,08	22,60	40	43,20	904,00
<b>15x60</b>	10	0,90	18,80	48	43,20	902,00
<b>30x30</b>	11	0,99	20,70	46	45,54	952,00
<b>10x30</b>	20	0,60	12,90	60	36,00	774,00
<b>15x15</b>	46	1,035	21,70	33	34,15	716,00

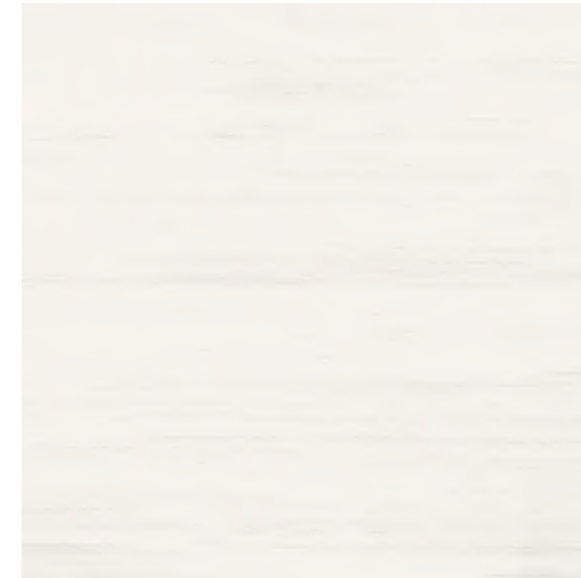

**606174**  
WHITE DOLOMITE NATURALE RETTIFICATO 60x60  
Cod. **79** □

**606175**  
WHITE DOLOMITE LAPPATO RETTIFICATO 60x60  
Cod. **93** □



**490567**  
WHITE DOLOMITE NATURALE  
RETTIFICATO 30x60  
Cod. **76** □

**490568**  
WHITE DOLOMITE LAPPATO  
RETTIFICATO 30x60  
Cod. **85** □

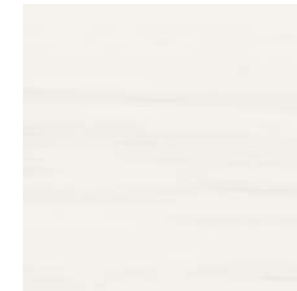

**041030**  
WHITE DOLOMITE NATURALE RETTIFICATO 30x30  
Cod. **78** □

**041031**  
WHITE DOLOMITE LAPPATO RETTIFICATO 30x30  
Cod. **90** □



**103088**  
WHITE DOLOMITE NATURALE  
RETTIFICATO 10x30  
Cod. **77** □

**103089**  
WHITE DOLOMITE LAPPATO  
RETTIFICATO 10x30  
Cod. **93** □

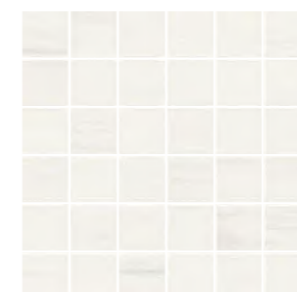

**041034**  
WHITE DOLOMITE NATURALE  
5x5 MOSAICO SU RETE 30x30  
Cod. **24** ○

**041035**  
WHITE DOLOMITE LAPPATO  
5x5 MOSAICO SU RETE 30x30  
Cod. **31** ○



**041038**  
WHITE DOLOMITE NATURALE  
MOSAICO ESAGONO  
SU RETE 27x28  
Cod. **136** ○

**041039**  
WHITE DOLOMITE LAPPATO  
MOSAICO ESAGONO SU RETE 27x28  
Cod. **49** ○

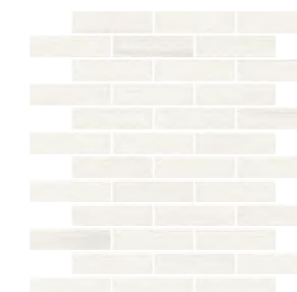

**041036**  
WHITE DOLOMITE NATURALE  
MURETTO 2,4x10  
SU RETE 30x30  
Cod. **46** ○

**041037**  
WHITE DOLOMITE LAPPATO  
MURETTO 2,4x10  
SU RETE 30x30  
Cod. **58** ○

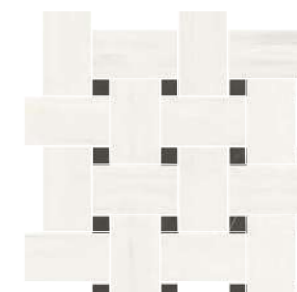

**041040**  
WHITE DOLOMITE NATURALE  
MOSAICO BASKETWAVE  
SU RETE 30x30  
Cod. **47** ○

**041041**  
WHITE DOLOMITE LAPPATO  
MOSAICO BASKETWAVE  
SU RETE 30x30  
Cod. **60** ○



**041058**  
WHITE DOLOMITE NATURALE  
MOSAICO ESAGONO BLEND  
SU RETE 21,5x18,6  
Cod. **25** ○

**041059**  
WHITE DOLOMITE LAPPATO  
MOSAICO ESAGONO BLEND  
SU RETE 21,5x18,6  
Cod. **34** ○



5,70 kg



**380246**  
WHITE DOLOMITE NATURALE  
BORDURA MURETTO  
SU RETE 7,3x30  
Cod. **28** ○

**380247**  
WHITE DOLOMITE LAPPATO  
BORDURA MURETTO  
SU RETE 7,3x30  
Cod. **28** ○



3,60 kg



**380244**  
WHITE DOLOMITE NATURALE  
LONDON 5x30  
Cod. **33** ○

**380245**  
WHITE DOLOMITE LUCIDO  
LONDON 5x30  
Cod. **33** ○



6,11 kg



## white dolomite RETT. LAPPATO

La finitura lappata è consigliata per uso rivestimento o per pavimenti da bagno in ambito residenziale. Nello specifico il tipo di pavimentazione deve essere non soggetta ad eccessive sollecitazioni e mai a diretto contatto con aree esterne. Come si verifica comunemente nelle pietre naturali l'eventuale presenza di puntini sulla superficie o di qualche disuniformità della lucentezza sono da considerare caratteristiche del prodotto derivanti dalla lavorazione a cui viene sottoposto.









The polished finish is recommended for wall coverings or for the floors of residential bathrooms. Specifically, floor coverings in this material must not be subjected to excessively heavy traffic and must never be in direct contact with outdoor areas. As is often the case with natural stones, any spots on the surface or any unevenness in shine are typical characteristics of the product, deriving from the process used.

La finitura polie est recommandée pour le revêtement sol et mur des salles de bains résidentielles. Notamment, ce type de carreau au sol ne doit pas être exposé à des contraintes excessives, et il ne doit jamais être en contact direct avec des zones extérieures. Comme cela est souvent le cas pour les pierres naturelles, les micro trous éventuellement présents à la surface du produit ou l'hétérogénéité de son éclat forment des caractéristiques propres au façonnage.

Die polierte Oberfläche wird für Wandverkleidungen und Bodenbeläge in Privatbädern empfohlen. Der Bodenbelag darf keinen starken Beanspruchungen ausgesetzt sein und keinen direkten Kontakt zu Außenbereichen haben. Wie bei Natursteinen üblich, kann die Oberfläche Körnungen oder einen unregelmäßigen Glanz aufweisen. Diese Merkmale sind typische, beabsichtigte Produkteigenschaften, die durch das Bearbeitungsverfahren hervorgerufen werden.

Pezzi speciali • Special trims • Pièces spéciales • Formstücke

Battiscopa	44 22,40 kg	18 17,10 kg
	<b>290668</b> WHITE DOLOMITE NATURALE BATTISCOPA 7x30 Cod. <b>116</b> △	<b>290733</b> WHITE DOLOMITE NATURALE BATTISCOPA 7x60 Cod. <b>121</b> △
	<b>290669</b> WHITE DOLOMITE LAPPATO BATTISCOPA 7x30 Cod. <b>22</b> △	<b>290734</b> WHITE DOLOMITE LAPPATO BATTISCOPA 7x60 Cod. <b>26</b> △

CARATTERISTICHE DI QUALITÀ Quality characteristics Caractéristiques de qualité Qualitätseigenschaften	NORMA Norm Norme Norme	REQUISITO NORMA Required standards Valeur prescrite selon la norme Normvorgabe	RISULTATO Result Résultat Ergebniss
 Assorbimento d'acqua Water absorption of the body Absorption d'eau de support Wasseraufnahme des Scherbens	ISO 10545-3	≤ 0,5	Conforme Conformity Conforme Gemäss
 Resistenza a flessione Breaking strenght Résistance à la flexion Biegefestigkeit	ISO 10545-4	≥ 35 N/mm <sup>2</sup>	Conforme Conformity Conforme Gemäss
 Resistenza all'abrasione Abrasion resistance Résistance à l'abrasion Abriebbeständigkeit	EN ISO 10545-7	White Dolomite Rettificato	PEI IV
	EN ISO 10545-6	White Dolomite Lappato	
 Resistenza al gelo Frost resistance Résistance au gel Frostbeständigkeit	ISO 10545-12	Nessun campione deve presentare rotture o alterazioni apprezzabili alla superficie No samples must show ruptures or noticeable surface alteration Aucuns enchantions doit présenter ruptures ou altérations appréciables de la surface Keines der Muster sollte Risse oder sichtbare Fehler der Oberflaeche zeigen	Conforme Conformity Conforme Gemäss
 Resistenza all'attacco chimico Chemical resistance Résistance à l'attaque chimique Beständigkeit gegen chemikalien	ISO 10545-13	White Dolomite Rettificato	GA GLA
		White Dolomite Lappato	GA GLB
 Resistenza agli sbalzi termici Thermal shock resistance Résistance aux écarts de température Temperaturwechselbeständigkeit	ISO 10545-5		Conforme Conformity Conforme Gemäss
 Resistenza scivolosità Sliding resistance Résistance au glissement Rutschfestigkeit	DIN 51130 R	White Dolomite Rettificato	R9
		White Dolomite Lappato	
 Lieve variazione Slight variation Légère variation Geringe Abweichung			V2

 Aspetto uniforme  
Uniform appearance  
Aspect uniforme  
Einheitliches Aussehen  
**V1**

 Lieve variazione  
Slight variation  
Légère variation  
Geringe Abweichung  
**V2**

 Significativa variazione  
Significant variation  
Variation important  
Bedeutsam Abweichung  
**V3**

 Forte stonalizzazione  
Substantial variation  
Effet dénuancé très accentué  
Akzentuierte Variation  
**V4**

**PER UNA POSA OTTIMALE DEL PRODOTTO CONSIGLIAMO SEMPRE DI MESCOLARE ALMENO TRE SCATOLE DI MATERIALE.**

For the best product laying results, material from at least three boxes should be mixed.

Pour une pose excellente, nous recommandons toujours de mélanger le contenu d'au moins trois boîtes.

Für eine optimale Verlegung des Erzeugnisses empfehlen wir stets, mindestens drei Packungen Material anzumischen.



Tipologia  
Type  
Typologie  
Typ  
Gres porcellanato smaltato  
Glazed porcelain  
Grès cérame emaille  
Feinsteinzeug glasiert

Formati  
Sizes  
Formats  
Formate  
120x120  
60x120  
60x60  
30x60  
30x30  
10x30

Spessore  
Thickness  
Épaisseur  
Stärke  
9 mm

Resistenza scivolosità  
Sliding resistance  
Resistance au glissement  
Rutschfestigkeit  
R9

Grado di variazione cromatica  
Degree of colour change  
Degré de variation chromatique  
Grad der Farbabweichung  
V3

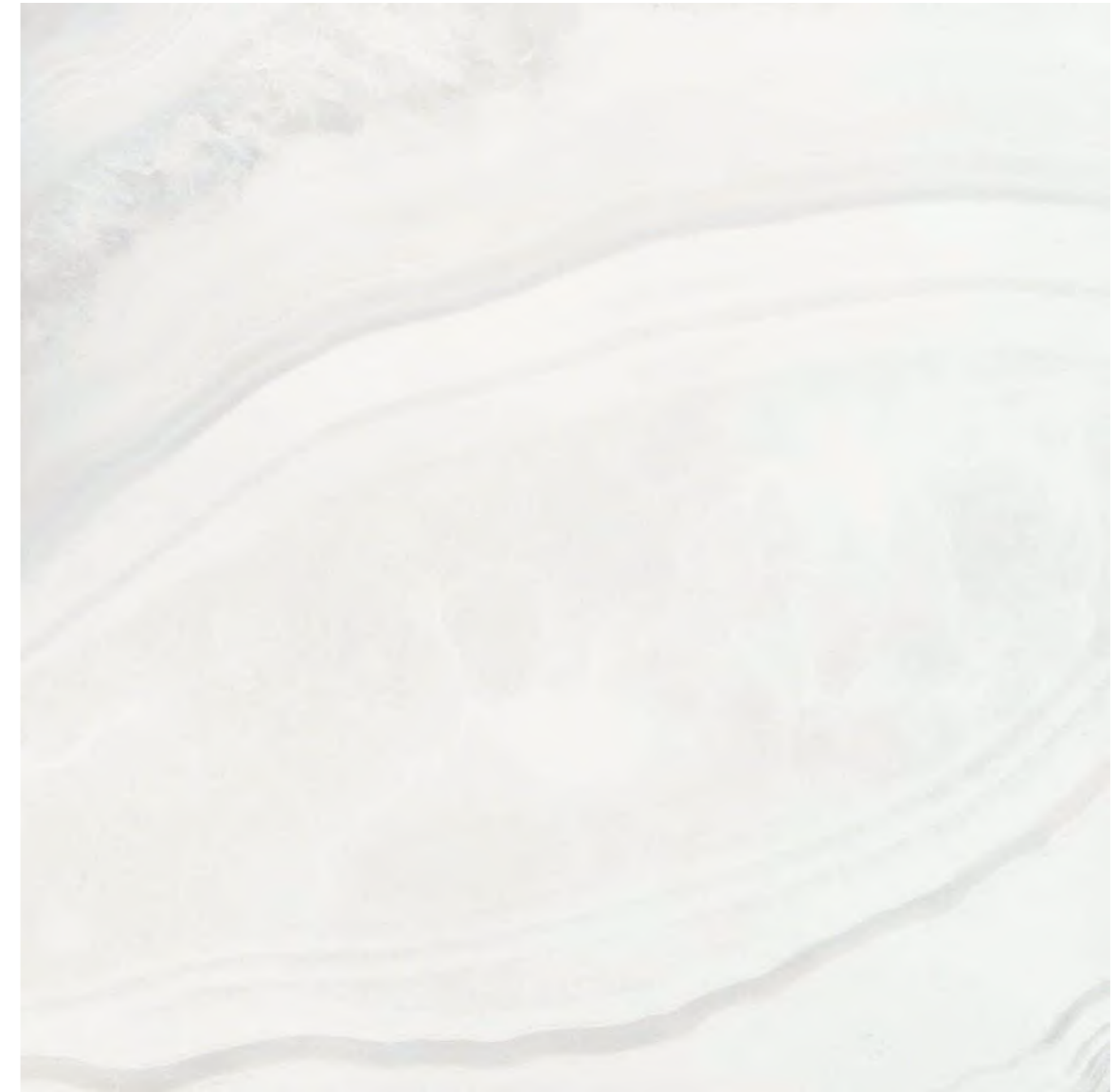

**121223**  
WHITE ONYX NATURALE  
RETTIFICATO 120x120  
Cod. **100** □

**121224**  
WHITE ONYX LAPPATO  
RETTIFICATO 120x120  
Cod. **141** □



**601274**  
WHITE ONYX NATURALE  
RETTIFICATO 60x120  
Cod. **94** □

**601275**  
WHITE ONYX LAPPATO  
RETTIFICATO 60x120  
Cod. **103** □

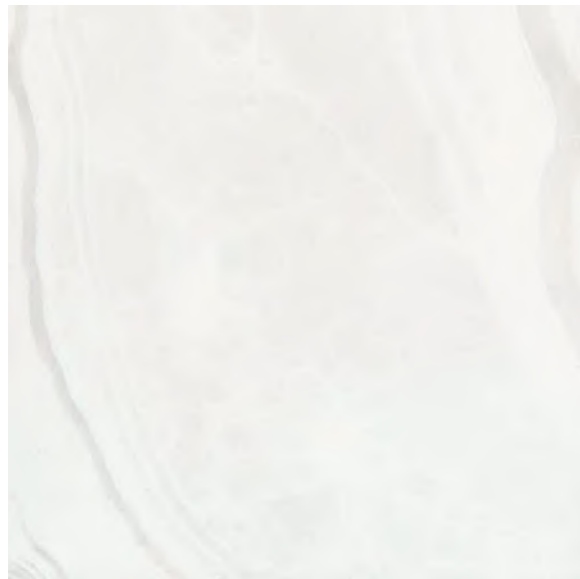

**606219**  
WHITE ONYX NATURALE  
RETTIFICATO 60x60  
Cod. **79** □

**606220**  
WHITE ONYX LAPPATO  
RETTIFICATO 60x60  
Cod. **93** □



**490681**  
WHITE ONYX NATURALE  
RETTIFICATO 30x60  
Cod. **76** □

**490682**  
WHITE ONYX LAPPATO  
RETTIFICATO 30x60  
Cod. **85** □



**041204**  
WHITE ONYX NATURALE RETTIFICATO 30x30  
Cod. **78** □

**041205**  
WHITE ONYX LAPPATO RETTIFICATO 30x30  
Cod. **90** □



**103113**  
WHITE ONYX NATURALE  
RETTIFICATO 10x30  
Cod. **77** □

**103114**  
WHITE ONYX LAPPATO  
RETTIFICATO 10x30  
Cod. **93** □



**041206**  
WHITE ONYX NATURALE  
MOSAICO 5x5 SU RETE 30x30  
Cod. **24** ○

**041207**  
WHITE ONYX LAPPATO  
MOSAICO 5x5 SU RETE 30x30  
Cod. **31** ○



9,30 kg



**041212**  
WHITE ONYX NATURALE  
MOSAICO ESAGONO SU RETE 27x28  
Cod. **136** ○

**041213**  
WHITE ONYX LAPPATO  
MOSAICO ESAGONO SU RETE 27x28  
Cod. **49** ○



8,90 kg



**041218**  
WHITE ONYX NATURALE  
MOSAICO HB SU RETE 28x32  
Cod. **45** ○

**041219**  
WHITE ONYX LAPPATO  
MOSAICO HB SU RETE 28x32  
Cod. **48** ○



10,20 kg



**041214**  
WHITE ONYX NATURALE  
ESAGONO INTARSIO SU RETE 20,7x27  
Cod. **57** ○

**041215**  
WHITE ONYX LAPPATO  
ESAGONO INTARSIO SU RETE 20,7x27  
Cod. **72** ○



6,50 kg



**380287**  
WHITE ONYX NATURALE  
BORDURA MURETTO 7x30  
Cod. **28** ○

**380288**  
WHITE ONYX LAPPATO  
BORDURA MURETTO 7x30  
Cod. **28** ○



3,60 kg



**380285**  
WHITE ONYX NATURALE  
LONDON 5x30  
Cod. **33** ○

**380286**  
WHITE ONYX LUCIDO  
LONDON 5x30  
Cod. **33** ○



6,11 kg

**IMBALLI • PACKAGES • EMBALLAGES • FORMATE**

	SCATOLA • BOX • BOITE • KARTON			PALLET • PALLETS • PALETTS • PALETTE		
	pz	mq	kg	box	mq	kg
<b>120x120</b>	2	2,88	68,80	18	51,84	1.238,00
<b>60x120</b>	2	1,44	30,20	30	43,20	906,00
<b>60x60</b>	3	1,08	22,60	40	43,20	904,00
<b>30x60</b>	6	1,08	22,60	40	43,20	904,00
<b>30x30</b>	11	0,99	21,20	46	45,54	975,00
<b>10x30</b>	20	0,60	12,90	60	36,00	774,00



## white onyx RETT. LAPPATO

La finitura lappata è consigliata per uso rivestimento o per pavimenti da bagno in ambito residenziale. Nello specifico il tipo di pavimentazione deve essere non soggetta ad eccessive sollecitazioni e mai a diretto contatto con aree esterne. Come si verifica comunemente nelle pietre naturali l'eventuale presenza di puntini sulla superficie o di qualche disuniformità della lucentezza sono da considerare caratteristiche del prodotto derivanti dalla lavorazione a cui viene sottoposto.

The polished finish is recommended for wall coverings or for the floors of residential bathrooms. Specifically, floor coverings in this material must not be subjected to excessively heavy traffic and must never be in direct contact with outdoor areas. As is often the case with natural stones, any spots on the surface or any unevenness in shine are typical characteristics of the product, deriving from the process used.

La finition polie est recommandée pour le revêtement sol et mur des salles de bains résidentielles. Notamment, ce type de carreau au sol ne doit pas être exposé à des contraintes excessives, et il ne doit jamais être en contact direct avec des zones extérieures. Comme cela est souvent le cas pour les pierres naturelles, les micro trous éventuellement présents à la surface du produit ou l'hétérogénéité de son éclat forment des caractéristiques propres au façonnage.

Die polierte Oberfläche wird für Wandverkleidungen und Bodenbeläge in Privatbädern empfohlen. Der Bodenbelag darf keinen starken Beanspruchungen ausgesetzt sein und keinen direkten Kontakt zu Außenbereichen haben. Wie bei Natursteinen üblich, kann die Oberfläche Körnungen oder einen unregelmäßigen Glanz aufweisen. Diese Merkmale sind typische, beabsichtigte Produkteigenschaften, die durch das Bearbeitungsverfahren hervorgerufen werden.

Pezzi speciali • Special trims • Pièces spéciales • Formstücke

Battiscopa



22,40 kg



17,10 kg

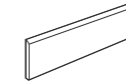

**290754**  
WHITE ONYX NATURALE  
BATTISCOPA 7x30  
Cod. **116** △

**290755**  
WHITE ONYX LAPPATO  
BATTISCOPA 7x30  
Cod. **22** △

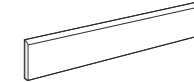

**290756**  
WHITE ONYX NATURALE  
BATTISCOPA 7x60  
Cod. **121** △

**290757**  
WHITE ONYX LAPPATO  
BATTISCOPA 7x60  
Cod. **26** △

	CARATTERISTICHE DI QUALITÀ QUALITY CHARACTERISTICS CARACTÉRISTIQUES DE QUALITÉ QUALITÄTSEIGENSCHAFTEN	NORMA NORM NORME NORME	REQUISITO NORMA REQUIRED STANDARDS VALEUR PRESCRITE SELON LA NORME NORMVORGABE	RISULTATO RESULT RÉSULTAT ERGEBNISS
	Assorbimento d'acqua Water absorption of the body Absorption d'eau de support Wasseraufnahme des Scherbens	ISO 10545-3	≤ 0,5	Conforme Conformity Conforme Gemäss
	Resistenza a flessione Breaking strenght Résistance à la flexion Biegefestigkeit	ISO 10545-4	≥ 35 N/mm <sup>2</sup>	Conforme Conformity Conforme Gemäss
	Resistenza all'abrasione Abrasion resistance Résistance à l'abrasion Abriebbeständigkeit	ISO 10545-7	White Onyx Rettificato	PEI IV
	Resistenza al gelo Frost resistance Résistance au gel Frostbeständigkeit	ISO 10545-12	Nessun campione deve presentare rotture o alterazioni apprezzabili alla superficie No samples must show ruptures or noticeable surface alteration Aucuns enchantions doit présenter ruptures ou altérations appréciables de la surface Keines der Muster sollte Risse oder sichtbare Fehler der Oberfläche zeigen	Conforme Conformity Conforme Gemäss
	Resistenza all'attacco chimico Chemical resistance Résistance à l'attaque chimique Beständigkeit gegen chemikalien	ISO 10545-13	White Onyx Naturale White Onyx Lappato	GA GLA GA GLB
	Resistenza agli sbalzi termici Thermal shock resistance Résistance aux écarts de température Temperaturwechselbeständigkeit	ISO 10545-5		Conforme Conformity Conforme Gemäss
	Resistenza scivolosità Sliding resistance Résistance au glissement Rutschfestigkeit	DIN 51130 R		R9
	Significativa variazione Significant variation Variation important Bedeutsam Abweichung		White Onyx Rettificato	V3

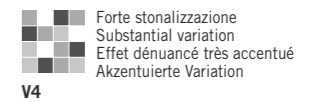
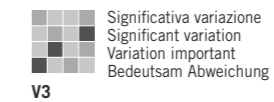
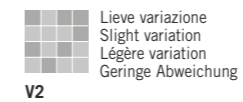
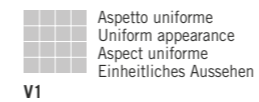

**PER UNA POSA OTTIMALE DEL PRODOTTO CONSIGLIAMO SEMPRE DI MESCOLARE ALMENO TRE SCATOLE DI MATERIALE.**

For the best product laying results, material from at least three boxes should be mixed.

Pour une pose excellente, nous recommandons toujours de mélanger le contenu d'au moins trois boîtes.

Für eine optimale Verlegung des Erzeugnisses empfehlen wir stets, mindestens drei Packungen Material anzumischen.



## **CONDIZIONI GENERALI DI VENDITA**

---

General conditions of sale

Conditions Générales de vente

Allgemeine Geschäftsbedingungen

## Condizioni generali di vendita

**1. NORMATIVA CONTRATTUALE** Le presenti condizioni generali, salvo modificazioni o deroghe concordate per iscritto, disciplinano tutti i contratti di vendita fra Gazzini S.p.A. e l'Acquirente. Le variazioni delle condizioni generali di vendita, le offerte, gli accrediti o gli abbuoni accordati dai nostri agenti o altri intermediari, non sono validi se non accettate per iscritto dalla nostra sede.

**2. OGGETTO DELLA FORNITURA** La fornitura comprende solamente i materiali, le prestazioni ed i quantitativi specificati nella nostra conferma d'ordine. Il testo della conferma d'ordine Gazzini S.p.A. prevarrà in ogni caso sul testo difforme della eventuale offerta o della ordinazione.

**3. CONFERMA D'ORDINE** Qualora nella conferma d'ordine Gazzini S.p.A. esistano differenze nei singoli elementi che la compongono rispetto alle intese od alle ordinazioni, l'Acquirente che non abbia contestato per iscritto entro 7gg dalla ricezione della nostra conferma s'intende che l'abbia accettata così come è stata redatta. Il cliente si impegna a comunicare a Gazzini S.p.A. l'eventuale variazione del luogo di destinazione della merce, se diverso da quello citato nella conferma d'ordine, entro e non oltre il giorno previsto per il ritiro presso Gazzini S.p.A., mediante invio, tramite posta, fax o e-mail, dei dati identificativi del destinatario delle merci e del luogo presso il quale dovrà essere effettuata la consegna. In mancanza di tale comunicazione la destinazione originariamente indicata si intende tacitamente confermata.

**4. PREZZI** I prezzi indicati sui listini Gazzini S.p.A. non sono impegnativi: di conseguenza ci riserviamo il diritto di modificarli prima dell'accettazione dell'ordine. I prezzi pattuiti per ogni singola vendita si intendono al netto, per contanti per consegna franco stabilimento, salvo diversa pattuizione scritta. Se fra la data di ordinazione (anche dopo la conferma d'ordine) e quella di consegna si verificassero aumenti nei costi delle materie prime, della manodopera, dei combustibili, nelle spese di produzione, di trasporto ecc., Gazzini S.p.A. potrà aumentare il prezzo convenuto dandone comunicazione scritta all'Acquirente anche a mezzo fax o posta elettronica. Tuttavia qualora detto prezzo superi del 20% quello convenuto al momento dell'ordinazione, l'Acquirente potrà recedere dal contratto notificandoci per raccomandata tale sua volontà entro il termine perentorio di 10 gg dal ricevimento dell'avviso dell'aumento di prezzo. In difetto, il nuovo prezzo s'intenderà accettato.

**5. CONSEGNE** La vendita è sempre franco stabilimento di Gazzini S.p.A.. La merce viaggia a rischio e pericolo dell'Acquirente ed ogni nostra responsabilità cessa con la consegna al vettore, nei confronti del quale l'Acquirente, effettuate le opportune verifiche, dovrà sporgere eventuali reclami. Le spedizioni, via mare o via terra, concernenti forniture sull'estero, vengono effettuate in base alle condizioni scelte di volta in volta, riportate negli "Incoterms" approvati dalla Camera di Commercio Internazionale.

**6. TERMINI DI CONSEGNA** I termini di consegna hanno carattere indicativo: eventuali ritardi nelle consegne, interruzioni, sospensioni totali o parziali delle forniture non daranno diritto ad indennizzi o risarcimento danni se non diversamente concordato per iscritto.

**7. CAMPIONI** I dati figuranti nei documenti illustrativi di Gazzini S.p.A., così come le caratteristiche dei campioni e modelli da quest'ultimo inviati l'Acquirente, hanno carattere di indicazioni approssimative. Questi dati non hanno valore impegnativo se non nella misura in cui siano stati espressamente menzionati come tali nell'offerta o nell'accettazione scritta di Gazzini S.p.A..

**8. PAGAMENTI** Le fatture di Gazzini S.p.A. vengono emesse il giorno della fornitura e devono essere pagate al netto alla scadenza pattuita. Ogni e qualsiasi obbligazione di pagamento tra le parti contraenti deve essere adempiuta presso la sede di Gazzini S.p.A. Eventuali pagamenti fatti ad agenti, rappresentanti o ausiliari di commercio di Gazzini S.p.A. non si intendono effettuati finché le relative somme non pervengano a Gazzini S.p.A.. Il pagamento dovrà essere effettuato, salvo diverso accordo scritto, contestualmente alla consegna, presso l'Istituto bancario indicato di Gazzini S.p.A.. Qualsiasi ritardo o irregolarità nel pagamento dà a Gazzini S.p.A. il diritto di sospendere le forniture o di risolvere i contratti in corso, anche se non relativi ai pagamenti in questione, nonché il diritto al risarcimento degli eventuali danni. Gazzini S.p.A. ha comunque diritto – a decorrere dalla scadenza del pagamento, senza necessità di messa in mora - agli interessi moratori nella misura prevista dal d.lgs. 09/10/2002 n. 231. In caso d'inadempimento, anche solo parziale, gli interessi moratori sull'importo non pagato decorreranno dal giorno della consegna anche se il termine di pagamento era stato convenuto a data successiva. Nessuna contestazione o controversia inerente alla qualità della merce, a vizi o difetti, o a qualsiasi altro aspetto del contratto, sarà efficace e potrà essere presa in considerazione, e così pure nessuna azione potrà essere iniziata se non dopo l'avvenuto integrale pagamento del prezzo (clausola solve et repete). Non è ammessa compensazione con eventuali crediti, comunque insorti, nei confronti di Gazzini S.p.A..

**9. GARANZIE E RECLAMI** La qualità del materiale ceramico è definita sulla base delle vigenti normative internazionali applicabili alla corrispondente classe di prodotto. Gazzini S.p.A. garantisce la sola merce fornita in prima scelta. Reclami relativi a merce in scelta differente dalla prima (commerciale, seconda, terza, secondaria, stock, etc.) non saranno presi in considerazione, né viene data implicitamente od esplicitamente alcun tipo di garanzia su tali materiali. È fatto obbligo all'Acquirente di verificare la merce in termini di qualità e quantità entro breve tempo dal ricevimento e, in caso di reclamo, darne comunicazione per iscritto entro e non oltre 8 (otto) giorni dal ricevimento stesso pena la decadenza da ogni diritto. Il materiale considerato difettoso dovrà essere tenuto a disposizione di Gazzini S.p.A. per le verifiche che riterrà opportuno effettuare; ogni ulteriore azione (restituzione, riparazione o altro) dovrà essere preventivamente autorizzata per iscritto da Gazzini S.p.A.. Reclami e richieste di intervento in garanzia dopo la posa in opera non saranno presi in esame nel caso in cui il difetto contestato dovesse risultare palese (es. sbeccate, difetti dimensionali, differenze di tono, ecc.). Si precisa che la prima scelta può contenere piastrelle difettose nel limite del 5% e che la tonalità del materiale fornito può differire dal campione esposto, essendo la ceramica intrinsecamente variabile come aspetto. I reclami imputati a difetti o vizi occulti dovranno essere formalizzati per iscritto entro 8 (otto) giorni dalla scoperta e, in ogni caso, entro un anno dalla consegna, pena la decadenza da ogni diritto alla garanzia e di risarcimento. La comunicazione dovrà contenere, oltre i dati di fatturazione, una precisa descrizione del vizio, un preventivo dei costi di riparazione o modificazione del prodotto; in mancanza di questi dati il reclamo si considera nullo. Qualora il reclamo dovesse risultare infondato l'Acquirente dovrà risarcire Gazzini S.p.A. di tutte le spese sostenute per l'accertamento (viaggi, perizie, ecc.). L'obbligo di Gazzini S.p.A. è, in ogni caso, limitato alla sostituzione dei soli pezzi difettosi o alla riparazione, con espressa esclusione di ulteriori diversi indennizzi quali, a titolo indicativo ma non limitativo, per costi di rimozione e risistemazione

di mobilio, attrezzature, macchinari ecc., mancati guadagni per interruzione o sospensione di attività, disagi, danni indiretti ecc. La presenza di piastrelle difettose non inficia la qualità dell'intera fornitura né comporta l'obbligo della integrale sostituzione. I limiti temporali della durata della garanzia sono quelli stabiliti dal codice civile italiano.

**10. RISERVATO DOMINIO** La vendita della merce viene effettuata con la clausola del riservato dominio; pertanto, nel caso in cui il pagamento, per accordi contrattuali, debba essere effettuato, in tutto o in parte dopo la consegna, i prodotti consegnati restano di proprietà Gazzini S.p.A. fino all'integrale pagamento del prezzo.

**11. CESSIONE DEL CONTRATTO** L'Acquirente non può cedere la sua posizione nel contratto od in singoli rapporti obbligatori da questo derivanti senza l'accettazione scritta di Gazzini S.p.A.: anche in tal caso l'Acquirente rimane comunque solidalmente responsabile col cessionario per le obbligazioni cedute.

**12. PROPRIETA' INDUSTRIALE E DISTRIBUZIONE SELETTIVA - LIMITI ALLA RIVENDITA** Gazzini S.p.A. è titolare e legittimo detentore di esclusive relative ai marchi, a disegni e brevetti di invenzione. Al fine di garantire al meglio il rispetto dei diritti esclusivi di Gazzini S.p.A., nonché le aspettative dei consumatori finali in ordine alle caratteristiche qualitative attese, Gazzini S.p.A. gestisce le forniture dei propri prodotti mediante un sistema di distribuzione selettiva. Le forniture ricevute da Gazzini S.p.A. e dai propri punti vendita selettivi autorizzati sono destinate all'installazione presso l'utente finale e non è consentita altra forma di rivendita a ulteriori intermediari commerciali diversi dagli utenti finali, salvo previa autorizzazione iscritta da parte di Gazzini S.p.A.. La rivendita della merce in violazione di tale divieto deve considerarsi pertanto non consentita ed equiparata ad uso illecito dei diritti di proprietà industriale e intellettuale di Gazzini S.p.A., con diritto di Gazzini S.p.A. di chiederne il sequestro presso qualunque detentore. Gazzini S.p.A. si riserva il diritto di procedere giudizialmente nei confronti di chiunque sia coinvolto in rivendite non autorizzate.

**13. LEGGE DEL CONTRATTO - FORO COMPETENTE** Il contratto è disciplinato dalla legge italiana, compresi gli Usi di settore della Provincia di Reggio Emilia. Per qualsiasi controversia comunque derivante dal contratto di fornitura, tanto da parte di Gazzini S.p.A. come da parte dell'Acquirente, è esclusivamente competente il Tribunale di Reggio Emilia. È comunque in facoltà di Gazzini S.p.A. adire autorità giudiziarie diverse.

## General conditions of sale

**1. CONTRACTUAL REGULATIONS** These general conditions, subject to modifications or waivers agreed in writing, govern all sales contracts between Gazzini S.p.A. and the Purchaser. Variations in the general conditions of sale, offers, credits or allowances agreed by our agents or other intermediaries, are not valid unless accepted in writing by our head office.

**2. SUBJECT OF THE SUPPLY** The supply includes only the materials, services and quantities specified in our order confirmation. The text of the Gazzini S.p.A. order confirmation shall prevail in any case over any differing text of the offer or order.

**3. ORDER CONFIRMATION** If, in the Gazzini S.p.A. order confirmation, there are differences in the individual elements comprising it, compared with the agreements or the orders, the Purchaser is understood to have accepted our confirmation as it was drawn up, unless an objection to it is made in writing within 7 days of receipt of it. The customer undertakes to notify Gazzini S.p.A. of the place of destination of the goods, if different from the address quoted on the order confirmation. In the case of any variation in the place of destination, the identification data of the destination address for the goods and the place where delivery is to be made must be sent by post, fax or email, before the day laid down for collection at Gazzini S.p.A.'s premises. If no notification is received, the destination originally shown shall be understood as tacitly confirmed.

**4. PRICES** The prices shown in the Gazzini S.p.A. price-lists are not binding: we therefore reserve the right to modify them before acceptance of the order. The prices agreed upon for each individual sale are understood as net, for cash and for delivery ex-works, subject to any different written stipulation. If there should be increases in costs of raw materials, labour, fuel, production or transport costs, etc. between the order date (even after the order confirmation) and the delivery date, Gazzini S.p.A. may increase the agreed price, giving written notification to the Purchaser also by fax or email. However, if this price should exceed the price agreed at the time of order by 20%, the Purchaser may withdraw from the contract by notifying us by registered letter of his desire to do so within the deadline of 10 days from receipt of the notice of price increase. If he fails to do so, the price shall be understood as accepted.

**5. SHIPMENTS** The sale is always ex-works at the Gazzini S.p.A. premises. The goods travel at the Purchaser's risk and our liability ends with delivery to the carrier, to whom the Purchaser after performing suitable checks must make any claims that may arise. Shipments by sea or land concerning supplies carried out abroad are performed according to conditions chosen on a time-by-time basis, shown in the "Incoterms" approved by the International Chamber of Commerce.

**6. DELIVERY TIMES** Delivery times are by way of indication only: any delays in delivery and interruptions and total or partial suspensions of supplies shall not give rise to an entitlement to refunds or claims for compensation unless otherwise agreed in writing.

**7. SAMPLES** The data shown in the Gazzini S.p.A. illustrative documents, as well as the characteristics of samples and models sent by Gazzini S.p.A. to the Purchaser, is of an approximately indicative nature. This data has no binding value except to the extent to which they were expressly mentioned as such in Gazzini S.p.A.'s offer or written acceptance.

**8. PAYMENTS** Gazzini S.p.A.'s invoices are issued on the day of supply and must be paid net on the agreed expiry date. Each and every obligation for payment between the contracting parties must be performed at Gazzini S.p.A.'s head office. Any payments made to agents, sales representatives or assistants of Gazzini S.p.A. are not considered to have been carried out until the relative sums have reached Gazzini S.p.A.. Payment must be carried out, subject to any other written agreement, at the same time as the delivery, to the bank indicated by Gazzini S.p.A.. Any delay or irregularity in payment gives Gazzini S.p.A. the right to suspend supplies or to terminate

current contracts, even if they do not relate to the payments in question, as well as the right to claim any damages. Gazzini S.p.A. is in any case entitled – starting from the payment expiry date, and without the need for notice of default – to the interest on arrears to the extent provided for by Italian Legislative Decree No. 231 of 09/10/2002. In the case of non-fulfilment, even only partial, the interest on arrears for the unpaid amount shall start from the day of delivery even if the payment term was agreed on as a later date. No objection or dispute referring to the quality of the goods or to flaws or defects or to any other aspect of the contract shall be valid and can be taken into consideration; in addition, no action may be started up until after payment has been made of the entire amount of the price (solve et repete clause). Compensation to Gazzini S.p.A., with any credits, however they may have arisen, is not permitted.

**9. GUARANTEES AND COMPLAINTS** The quality of the ceramic material is defined on the basis of the prevailing international regulations applicable to the corresponding product class. Gazzini S.p.A. guarantees only goods supplied as prime quality. Complaints relating to goods other than of prime quality commercial, second, third, secondary, stock, etc.) shall not be taken into consideration, nor will any kind of guarantee be given, either implicitly or explicitly, on these materials. The Purchaser is obliged to check the goods in terms of quality and quantity within a short time after receipt and, in the case of a complaint, to give notification of this in writing no later than 8 (eight) days from receipt of the goods; failure to do so will incur the forfeiture of all rights. Material deemed to be defective must be held at Gazzini S.p.A.'s disposal for the checks that it will consider suitable to carry out; any further action (return, repair or other) must be authorized in advance by Gazzini S.p.A. in writing. Complaints and requests for intervention under guarantee after the material has been laid shall not be taken into account if the defect reported is evident (e.g. chips, defects of size, differences in colour shade, etc.). It is made clear that the prime quality may contain defective tiles up to a limit of 5% and that the colour shades of the material supplied may differ from the sample displayed, since ceramic is intrinsically variable in appearance. Complaints attributed to latent faults or defects must be formalized in writing within 8 (eight) days from their discovery and, in any case, within one year from delivery; failure to do so will incur the forfeiture of all rights under the guarantee and to compensation. As well as the invoice details, the notification must contain a precise description of the defect and an estimate of costs for repair or modification of the product; failure to notify this data will cause the complaint to be deemed invalid. If the complaint should prove to be unfounded the Purchaser must reimburse Gazzini S.p.A. for all the expenses incurred for assessment (travelling expenses, surveys, etc.). Gazzini S.p.A.'s obligation is, in any case, limited to replacing the defective pieces only or to repairing them, with the express exclusion of other, further indemnities such as, by way of a non-limiting example, for costs of removing and re-installing furniture, equipment, machinery, etc., or loss of earnings for interruption or suspension of business, inconvenience, consequential damages, etc. The presence of defective tiles does not invalidate the quality of the entire supply, nor does it incur the obligation for its entire replacement. The time limits for the duration of the guarantee are as established by the Italian Civil Code.

**10. RETENTION OF TITLE** Sale of the goods is carried out with the retention of title clause; therefore if payment, by contractual agreements, must be carried out wholly or in part after delivery, the products delivered remain the property of Gazzini S.p.A. until the entire price has been paid.

**11. TRANSFER OF CONTRACT** The Purchaser may not transfer his position in the contract or in individual binding agreements deriving from this without Gazzini S.p.A.'s written acceptance: also in this case the Purchaser anyway remains jointly liable with the transferee for the obligations transferred.

**12. INDUSTRIAL PROPERTY AND SELECTIVE DISTRIBUTION - LIMITS ON RESALE** Gazzini S.p.A. is the owner and legal holder of the exclusive rights to brand names, designs and patents. In order to guarantee full respect for Gazzini S.p.A.'s exclusive rights, as well as the end consumers' expectations with regard to expected quality characteristics, Gazzini S.p.A. manages the supplies of its products by means of a selective distribution system. Supplies received from Gazzini S.p.A. and from its authorized selective sales outlets are designed for installation at the end user's premises and no other form of resale to further sales agents other than the end users is permitted, unless with Gazzini S.p.A.'s prior written authorization. Goods that are re-sold in breach of this provision must therefore be considered as not permitted and treated as an unlawful use of Gazzini S.p.A.'s industrial and intellectual property rights, with Gazzini S.p.A.'s right to ask for them to be seized at the premises of any holder. Gazzini S.p.A. reserves the right to take legal proceedings against anyone who is involved in unauthorized re-selling.

**13. LAW GOVERNING THE CONTRACT - PLACE OF JURISDICTION** The contract is governed by Italian law, including the customs of the sector in Modena Province. For any dispute that may in any case derive from the supply contract, either on the part of Gazzini S.p.A. or on the part of the Purchaser, the Modena Court has exclusive competence. Gazzini S.p.A. nevertheless has the right to resort to different judicial authorities.

## Conditions Générales de vente

**1. NORME CONTRACTUELLE** Sauf modifications ou dérogations convenues par écrit, les présentes conditions générales s'appliquent à tous les contrats de vente entre Gazzini S.p.A. et l'Acquéreur. Les variations des conditions générales de vente, les offres, crédits ou réductions accordés par nos agents ou d'autres intermédiaires ne sont valables que s'ils ont été acceptés par écrit par notre siège.

**2. OBJET DE LA FOURNITURE** La fourniture correspond uniquement aux matériaux, prestations et quantités spécifiés dans notre confirmation de commande. Le texte de la confirmation de commande de Gazzini S.p.A. prévaut dans tous les cas par rapport au texte non conforme de la commande ou de l'offre éventuelle.

**3. CONFIRMATION DE COMMANDE** En cas de divergences des éléments de la confirmation de commande de Gazzini S.p.A. par rapport aux accords ou aux commandes, l'Acquéreur pourra formuler une réclamation écrite dans les 7 jours suivant la réception de notre confirmation. Passé ce délai, la commande sera considérée comme ayant été acceptée telle qu'elle a été rédigée. Le client s'engage à communiquer à Gazzini S.p.A. l'éventuelle variation du lieu de destination de la marchandise, si différente de celle prévue dans la confirmation de la commande, au plus tard le jour prévu du retrait chez Gazzini S.p.A., par l'envoi, par poste, fax ou e-mail, des données d'identification du destinataire des marchandises et du lieu où la livraison devra être effectuée. En cas de manquement de communication la destination indiquée à l'origine sera tacitement confirmée.

**4. PRIX** Les prix indiqués sur les catalogues Gazzini S.p.A. ne sont pas contraignants : nous nous réservons par conséquent le droit de les modifier préalablement à l'acceptation de la commande. Les prix convenus pour chaque vente s'entendent hors taxes, payés au comptant pour une livraison franco usine, sauf accord contraire stipulé par écrit. Si des hausses du coût des matières premières, de la main-d'oeuvre, des combustibles, des frais de production et de transport, etc. apparaissent entre la date de commande (même après la confirmation de commande) et la date de livraison, Gazzini S.p.A. pourra augmenter le prix convenu en informant l'Acquéreur par écrit, y compris par fax ou courrier électronique. Cependant, si ledit prix dépasse de 20 % celui convenu lors de la commande, l'Acquéreur pourra résilier le contrat en nous faisant part de sa volonté par lettre recommandée dans un délai préemptoire de 10 jours à compter de la réception de l'avis d'augmentation du prix. Dans le cas contraire, le nouveau prix sera considéré comme ayant été accepté.

**5. LIVRAISONS** La vente s'entend toujours franco usine Gazzini S.p.A.. La marchandise voyage aux risques et périls de l'Acquéreur. Toutes nos responsabilités prennent fin avec la remise au transporteur, auquel l'Acquéreur, après les contrôles de rigueur, devra s'adresser pour d'éventuelles réclamations. Les expéditions de fournitures à l'étranger par voie terrestre ou maritime sont effectuées selon les conditions choisies d'une fois sur l'autre, conformément aux Incoterms approuvés par la Chambre de commerce internationale.

**6. DÉLAIS DE LIVRAISON** Les délais de livraison sont donnés à titre indicatif : les éventuels retards de livraison, les interruptions, les suspensions totales ou partielles de fourniture n'ouvriront pas droit à une indemnisation ou à des dommages-intérêts, sauf accord contraire stipulé par écrit.

**7. ÉCHANTILLONS** Les informations reportées sur les documents d'illustration de Gazzini S.p.A., de même que les caractéristiques des échantillons et modèles envoyés par Gazzini S.p.A. à l'Acquéreur, sont données à titre purement indicatif. Ces données n'ont aucune valeur contraignante, à moins que cela ait été indiqué expressément dans l'offre ou dans l'acceptation écrite de Gazzini S.p.A..

**8. PAIEMENTS** Les factures de Gazzini S.p.A., émises au jour de la fourniture, doivent être payées conformément à l'échéance prévue. Toute obligation de paiement entre les parties contractantes doit être exécutée auprès du siège de Gazzini S.p.A.. Les paiements éventuels faits à des agents, représentants ou auxiliaires de commerce de Gazzini S.p.A. ne seront considérés comme effectifs qu'à compter de la réception par Gazzini S.p.A. des sommes dues. Sauf accord contraire stipulé par écrit, le paiement devra être effectué au moment de la livraison auprès de l'institut bancaire indiqué par Gazzini S.p.A.. Tout retard ou toute irrégularité de paiement donnera à Gazzini S.p.A. le droit de suspendre les fournitures ou de résilier les contrats en cours, y compris ceux qui ne sont pas en lien avec les paiements en question, et de demander le remboursement des dommages éventuellement subis. Gazzini S.p.A. peut quoi qu'il en soit prétendre – à compter de l'arrivée à échéance du paiement, et sans nécessité de mise en demeure – à des intérêts moratoires conformément à la loi n° 231 du 09/10/2002. En cas de manquement même partiel, les intérêts moratoires sur le montant restant dû courent à compter du jour de la livraison, même si le délai de paiement convenu est fixé à une date ultérieure. Aucune réclamation ni aucun litige portant sur la qualité de la marchandise, des vices ou des défauts ou tout autre aspect du contrat, n'aura de valeur et ne pourra être pris en considération, de même qu'aucune action ne pourra être initiée avant le paiement intégral du prix (clause solve et repete). Les compensations par d'éventuels crédits, même existants, vis-à-vis de Gazzini S.p.A., ne sont pas admises.

**9. GARANTIES ET RÉCLAMATIONS** La qualité des matériaux céramiques est définie sur la base des normes internationales en vigueur qui s'appliquent à la classe de produit correspondante. La garantie de Gazzini S.p.A. ne porte que sur la marchandise de premier choix fournie. Les réclamations relatives à des marchandises autres que celles de premier choix (commercial, 2e et 3e choix, secondaire, stock, etc.) ne seront pas prises en considération. Il ne sera donné aucun type de garantie sur ces matériaux, ni implicitement ni explicitement. Obligation est faite à l'Acquéreur de contrôler la qualité et la quantité de la marchandise rapidement après la livraison et, en cas de réclamation, d'en donner communication par écrit dans les 8 (huit) jours suivant la réception sous peine de déchéance de ses droits. Les matériaux considérés comme défectueux devront être laissés à la disposition de Gazzini S.p.A. pour les contrôles jugés opportuns ; toute action ultérieure (restitution, réparation ou autre) devra avoir été préalablement autorisée par écrit par Gazzini S.p.A.. Les réclamations et demandes d'intervention en garantie postérieures à la pose ne seront pas prises en considération si le défaut constaté est manifeste (ex. pièces ébréchées, défauts dimensionnels, différences de teinte, etc.). Il est précisé que le premier choix peut présenter des carreaux défectueux dans une limite de 5 % et que la teinte du matériau fourni peut différer de l'échantillon exposé, l'aspect de la céramique étant intrinsèquement variable. Les réclamations pour des défauts ou des vices cachés devront être adressées par écrit dans les 8 (huit) jours suivant leur découverte, et dans tous les cas dans l'année suivant la livraison, sous peine d'une déchéance de tout droit à la garantie et au remboursement. La réclamation devra mentionner, outre les références de facturation, une description précise du vice et un devis des coûts de réparation ou de modification du produit ; en l'absence de ces informations, la réclamation sera considérée comme nulle et non avenue. Si la réclamation se révèle infondée, l'Acquéreur devra rembourser à Gazzini S.p.A. toutes les dépenses engagées dans le cadre des contrôles (déplacements, expertises, etc.) effectués. Les obligations de Gazzini S.p.A. se limitent quoi qu'il en soit au remplacement des pièces défectueuses ou à leur réparation, à l'exclusion expresse de toute indemnisation ultérieure comme, à titre indicatif mais sans limitation aucune, pour des coûts de déplacement et de remise en place de mobilier, de matériel, de machines, etc., de manques à gagner du fait d'une interruption ou d'une suspension d'activité, de perturbations, de dommages indirects, etc. La présence de carreaux défectueux n'invalide pas la qualité de l'ensemble de la fourniture

et n'entraîne aucune obligation de remplacement intégral. Les limites temporelles de la durée de garantie sont celles définies par le code civil italien.

**10. RÉSERVE DE PROPRIÉTÉ** La vente de la marchandise s'effectue avec la clause de réserve de propriété. Par conséquent, si le paiement, du fait d'accords contractuels, est effectué en tout ou partie après la livraison, les produits livrés resteront la propriété de Gazzini S.p.A. jusqu'au paiement intégral du prix.

**11. CESSIION DU CONTRAT** L'Acquéreur ne peut pas céder ses droits et obligations ni chacune des relations obligatoires nés du présent contrat sans l'accord écrit de Gazzini S.p.A.: même dans ce cas, l'Acquéreur restera solidaire du cessionnaire vis-à-vis des obligations cédées.

**12. PROPRIÉTÉ INDUSTRIELLE ET DISTRIBUTION SÉLECTIVE - LIMITES À LA REVENTE** Gazzini S.p.A. est le titulaire et propriétaire légitime des exclusivités relatives aux marques, dessins et brevets d'invention. Pour garantir au mieux le respect des droits exclusifs de Gazzini S.p.A. et les attentes du consommateur final en matière de caractéristiques qualitatives, Gazzini S.p.A. gère la fourniture de ses produits par l'intermédiaire d'un système de distribution sélective. Les fournitures acquises auprès de Gazzini S.p.A. et de ses points de vente sélectifs agréés sont destinées à une installation auprès de l'utilisateur final ; aucune autre forme de revente à des intermédiaires commerciaux autres que les utilisateurs finals n'est autorisée, sauf autorisation préalable de Gazzini S.p.A. stipulée par écrit. Toute revente de marchandise en violation de ce principe doit donc être considérée comme interdite et assimilée à un usage illicite des droits de propriété industrielle et intellectuelle de Gazzini S.p.A., donnant droit à Gazzini S.p.A. de demander la saisie de ladite marchandise auprès de son détenteur. Gazzini S.p.A. se réserve le droit de poursuivre en justice quiconque serait impliqué dans des reventes non autorisées.

**13. LOI APPLICABLE ET JURIDICTION COMPÉTENTE** Le contrat est régi par la loi italienne, y compris les Usages de branche de la Province de Reggio Emilia. Le tribunal de Reggio Emilia est exclusivement compétent pour tout litige relatif au contrat de fourniture entre Gazzini S.p.A. et l'Acquéreur. Gazzini S.p.A. garde néanmoins la faculté de saisir d'autres autorités judiciaires.

## Allgemeine Geschäftsbedingungen

**1. VERTRAGSVORSCHRIFTEN** Alle Verkaufsverträge zwischen Gazzini S.p.A. und dem Käufer werden, vorbehaltlich schriftlich vereinbarter Änderungen oder Abweichungen, durch die vorliegenden allgemeinen Geschäftsbedingungen geregelt. Die Abänderungen der allgemeinen Geschäftsbedingungen, die Angebote, die von unseren Handelsagenten oder anderen Vermittlern gewährten Gutschriften oder Nachlässe haben nur Gültigkeit, sofern sie von unserem Sitz schriftlich angenommen wurden.

**2. GEGENSTAND DER LIEFERUNG** Die Lieferung umfasst nur die Materialien, Leistungen und Mengen, die in unserer Auftragsbestätigung angegeben sind. Der Text der Auftragsbestätigung von Gazzini S.p.A. hat auf jeden Fall Vorrang gegenüber dem Text, der von dem eventuellen Angebot oder der Bestellung abweichen sollte.

**3. AUFTRAGSBESTÄTIGUNG** Falls in der Auftragsbestätigung von Gazzini S.p.A. Unterschiede der darin aufgelisteten einzelnen Elemente gegenüber den Vereinbarungen oder Bestellungen bestehen, gilt die Bestätigung in ihrer abgefassten Form als angenommen, sofern der Käufer sie nicht binnen 7 Tagen nach Erhalt unserer Bestätigung schriftlich beanstandet hat.

**4. PREISE** Die auf den Gazzini S.p.A.-Preislisten angeführten Preise sind unverbindlich: Demzufolge behalten wir uns das Recht vor, sie vor der Auftragsannahme abzuändern. Sofern keine anderen schriftlichen Vereinbarungen vorliegen, verstehen sich die für jeden Einzelverkauf vereinbarten Preise netto, gegen bar, Lieferung ab Werk. Sollten zwischen dem Bestelldatum (auch nach der Auftragsbestätigung) und dem Lieferdatum ein Kostenanstieg der Rohstoffe, Löhne, Brennstoffe, Herstellung, des Transports, usw. auftreten, kann Gazzini S.p.A. den vereinbarten Preis erhöhen, indem er dies dem Käufer schriftlich, auch mittels Fax oder E-Mail, mitteilt. Sollte besagter Preis jedoch den bei der Bestellung vereinbarten Preis um 20% übersteigen, hat der Käufer die Möglichkeit, vom Vertrag zurückzutreten, indem er uns binnen der bindenden Frist von 10 Tagen nach Erhalt der Mitteilung bez. des Preisanstiegs seinen Willen per Einschreiben meldet. In Ermangelung dessen gilt der neue Preis als angenommen.

**5. LIEFERUNGEN** Der Verkauf ist immer ab Gazzini S.p.A.-Werk. Der Warentransport erfolgt auf Risiko und Gefahr des Käufers. Unsere Haftung endet mit der Übergabe an den Frachtführer, an den der Käufer nach angemessener Überprüfung eventuelle Beanstandungen zu richten hat.

Auslandslieferungen auf dem See- oder Landweg werden auf der Grundlage der von Fall zu Fall gewählten Bedingungen vorgenommen, die in den von der Internationalen Handelskammer gebilligten "Incoterms" aufgeführt sind.

**6. LIEFERBEDINGUNGEN** Die Lieferbedingungen sind hinweisend: Eventuelle Lieferverzögerungen, Unterbrechungen, komplette oder partielle Einstellungen der Lieferungen berechtigen weder zu einer Entschädigung noch zu einem Schadensersatz, sofern keine anderen schriftlichen Vereinbarungen vorliegen.

**7. MUSTER** Die auf den veranschaulichenden Dokumenten von Gazzini S.p.A. abgebildeten Angaben sowie die Eigenschaften der vom Letztgenannten dem Käufer zugesandten Muster und Modelle sind als ungefähre Angaben zu verstehen. Es handelt sich nicht um verbindliche Angaben, sofern sie nicht ausdrücklich als derartig im Angebot oder in der schriftlichen Annahme von Gazzini S.p.A. erwähnt wurden.

**8. ZAHLUNGEN** Die Rechnungen von Gazzini S.p.A. werden am Tag der Lieferung ausgestellt und sind netto innerhalb der vereinbarten Frist zu bezahlen.

Jegliche Zahlungsverpflichtung zwischen den Vertragsparteien ist am Gazzini S.p.A.-Sitz zu erfüllen. Eventuell an Handelsagenten, Vertreter oder Geschäftshelfer von Gazzini S.p.A. geleistete Zahlungen verstehen sich so lange als nicht vorgenommen, bis die bezüglichen Summen bei Gazzini S.p.A. eingehen. Die Bezahlung hat, vorbehaltlich anderer schriftlicher Vereinbarungen, unmittelbar nach der Lieferung beim Bankinstitut zu erfolgen, das von Gazzini S.p.A. angegeben wurde. Jegliche Zahlungsverzögerungen oder –unregelmäßigkeiten geben Gazzini S.p.A. das Recht, die Lieferungen einzustellen oder die laufenden Verträge aufzulösen, auch wenn sie sich nicht auf die zutreffenden Zahlungen beziehen, sowie das Recht auf den Ersatz etwaiger Schäden. Gazzini S.p.A. hat auf jeden Fall Anspruch auf die Verzugszinsen – ab der Zahlungsfrist und ohne die Notwendigkeit einer Inverzugsetzung – in der laut Gesetzesverordnung Nr. 231 vom 09.10.2002 vorgesehenen Höhe. Im Falle einer auch nur teilweisen Nichterfüllung laufen die Verzugszinsen für den nicht bezahlten Betrag ab dem Tag der Lieferung, auch wenn als Zahlungsfrist ein späteres Datum vereinbart wurde. Keine Beanstandung oder Streitigkeit bezüglich der Warenqualität, Mängel oder Defekte, oder jedes anderen Vertragsaspekts ist wirksam und kann in Betracht gezogen werden, und gleichermaßen kann keine Klage eingeleitet werden, sofern keine vollständige Bezahlung des Preises erfolgte (Klausel solve et repete). Die Verrechnung mit eventuell entstandenen Forderungen gegen Gazzini S.p.A. ist unzulässig.

**9. GARANTIEN UND BEANSTANDUNGEN** Die Qualität des Keramikmaterials wird auf der Grundlage der geltenden internationalen Rechtsvorschriften festgelegt, die auf die jeweilige Produktklasse Anwendung finden. Gazzini S.p.A. garantiert nur die als erste Wahl gelieferte Ware. Beanstandung über die nicht zur ersten Klasse gehörenden Waren (kommerzielle, zweite, dritte, zweitrangige Wahl, Lagerbestand, usw.) bleiben unberücksichtigt, wobei auf diese Materialien keine Art von Garantie, weder implizit noch explizit, erteilt wird. Der Käufer ist verpflichtet, die Ware binnen kurzer Zeit ab Erhalt auf Qualität und Quantität zu prüfen und bei einer Beanstandung diese schriftlich binnen spätestens 8 (acht) Tagen ab Warenerhalt mitzuteilen, da andernfalls jeglicher Anspruch verwirkt. Die als fehlerhaft betrachtete Ware ist Gazzini S.p.A. für seine als angemessen betrachteten Überprüfungen verfügbar zu halten; jeder weitere Vorgang (Rückerstattung, Reparatur oder sonstiges) bedarf der vorherigen schriftlichen Genehmigung von Gazzini S.p.A.. Beanstandungen und Beantragungen von Garantieeingriffen nach erfolgter Verlegung werden nicht in Betracht gezogen, sofern sich der beanstandete Defekt als offensichtlich erweisen sollte (zum Beispiel Schlagstellen, Maßunterschiede, Tonabweichungen, usw.). Es wird präzisiert, dass die erste Wahl bis zu 5% fehlerhafte Fliesen enthalten und die Farbgebung des gelieferten Materials vom ausgestellten Muster abweichen darf, da Keramik von Natur aus unterschiedlich aussehen kann. Auf verborgene Fehler oder Mängel bezogene Beanstandungen sind schriftlich binnen 8 (acht) Tagen ab ihrer Feststellung und auf jeden Fall binnen einem Jahr ab Lieferung zu formalisieren, da andernfalls die Verwirkung jeglichen Anspruchs auf Garantie und Entschädigung droht. Die Mitteilung muss neben den Rechnungsdaten eine genaue Beschreibung des Mangels und einen Kostenvoranschlag der Reparatur oder Änderung des Produkts enthalten; in Ermangelung dieser Angaben wird die Beanstandung als nichtig betrachtet. Sollte sich die Beanstandung als unbegründet erweisen, muss der Käufer Gazzini S.p.A. alle für die Überprüfung aufgebrauchten Kosten (Reisen, Sachverständigengutachten, usw.) vergüten. Die Pflicht von Gazzini S.p.A. beschränkt sich auf jeden Fall allein auf den Ersatz nur der fehlerhaften Teile oder auf die Reparatur, mit ausdrücklichem Ausschluss anderweitiger Entschädigungen wie beispielsweise - aber nicht ausschließlich - für Kosten zur Beseitigung und Wiederherrichtung von Möbeln, Ausrüstungen, Maschinen, usw., entgangene Gewinne wegen Tätigkeitsunterbrechung oder –einstellung, Unannehmlichkeiten, Folgeschäden, usw. Das Vorhandensein fehlerhafter Fliesen setzt weder die Güte der Gesamtlieferung herab noch ist damit die Pflicht des Gesamtersatzes verbunden. Die zeitlichen Beschränkungen der Garantiedauer sind laut dem italienischen Bürgerlichen Gesetzbuch festgelegt.

**10. EIGENTUMSVORBEHALT** Der Warenverkauf erfolgt mit der Klausel des Eigentumsvorbehalts; deshalb bleiben die gelieferten Produkte, sofern deren Bezahlung laut Vertragsvereinbarungen gänzlich oder teilweise nach der Lieferung zu erfolgen hat, bis zur vollkommenen Bezahlung des Preises Eigentum von Gazzini S.p.A..

**11. VERTRAGSABTRETUNG** Der Käufer darf seine Stellung im Vertrag oder in einzelnen, aus diesem herrührenden obligatorischen Verhältnissen ohne schriftliche Einwilligung von Gazzini S.p.A. nicht abtreten: Auch in diesem Fall haftet der Käufer weiterhin mit dem Unternehmer solidarisch für die abgetretenen Verpflichtungen.

**12. GEWERBLICHES EIGENTUM UND SELEKTIVER VERTRIEB - BESCHRÄNKUNGEN BEIM WEITERVERKAUF** Gazzini S.p.A. ist Inhaber und rechtmäßiger Besitzer von Allrechten bezüglich Marken, Zeichnungen und Erfinderpatenten. Um die Beachtung der Alleinrechte von Gazzini S.p.A. und die Ansprüche der Endkunden im Hinblick auf die erwarteten Güteeigenschaften auf ein Höchstmaß gewährleisten zu können, liefert Gazzini S.p.A. seine Produkte im Rahmen eines selektiven Vertriebssystems. Die von Gazzini S.p.A. und seinen dazu befugten selektiven Verkaufsstellen gelieferten Produkte sind für die Verlegung beim Endbenutzer bestimmt. Eine andere Form des Weiterverkaufs an weitere Handelsvermittler, die nicht den Endbenutzern entsprechen, ist ohne vorherige schriftliche Einwilligung von Gazzini S.p.A. unzulässig. Die Ware, dessen Weiterverkauf trotz dieses Verbots erfolgte, ist somit als unzulässig zu betrachten und einem unerlaubten Gebrauch der gewerblichen und geistigen Eigentumsrechte von Gazzini S.p.A. gleichzusetzen, wobei Gazzini S.p.A. berechtigt ist, die Beschlagnahme bei jedem Besitzer zu beantragen. Gazzini S.p.A. behält sich das Recht vor, gegen all diejenigen gerichtlich vorzugehen, die an einem unbefugten Weiterverkauf beteiligt sind.

**13. VERTRAGSGESETZ - ZUSTÄNDIGES GERICHT** Der Vertrag ist durch das italienische Gesetz, einschließlich der Branchengewohnheiten der Provinz Reggio Emilia, geregelt. Für jegliche aus dem Liefervertrag herrührende Streitigkeit sowohl seitens Gazzini S.p.A. als auch des Käufers ist allein das Gericht Reggio Emilia zuständig. Nur Gazzini S.p.A. kann eine andere zuständige Gerichtsbehörde anrufen.

**CATALOGO  
GENERALE**  
2024-2025

Catalogo - Listino Prezzi in vigore da 01/01/2024.

Il presente catalogo e listino prezzi annullano e sostituiscono i precedenti.

Le tonalità dei colori sono indicative.

L'azienda si riserva di modificare i prodotti illustrati nei presenti catalogo e listino prezzi in qualsiasi momento e senza preavviso.

Ceramica Gazzini SpA declina ogni responsabilità dovuta ad eventuali errori e/o omissioni nelle informazioni pubblicate.

Catalogue - Price List in force as of 01/01/2024.

These catalogue and price list cancel and replace all the previous ones.

These colour shades are indicative.

The company reserves the right to modify the products illustrated in these catalogue and price list at any time without prior notice.

Ceramica Gazzini SpA accepts no liability for errors and/or omissions in the information published.

Catalogue - Liste des Prix en vigueur à partir de 01/01/2024.

Le présent catalogue / liste des prix annule et remplace les précédent.

Les nuances des couleurs sont indicatives.

La société se réserve le droit de modifier, à tout moment et sans avis préalable, les produits figurant sur ce catalogue.

La responsabilité de Ceramica Gazzini SpA ne peut être mise en cause dans le cas d'éventuelles omissions et/ou erreurs qui se seraient glissées dans les informations publiées.

Katalog - Preisliste ab 01/01/2024.

Die vorliegenden Katalog und Preisliste annullieren und ersetzen die Vorigen.

Je nach Brand ist die Tonalität annähernd. Muster und Fliesen können deshalb leicht unterschiedlich ausfallen laut DIN Norm.

Die Firma behält sich vor, die in diesen Katalog und Preisliste abgebildeten Produkte jederzeit und ohne Vorankündigung abzuändern.

Ceramica Gazzini SpA lehnt jegliche Haftung für evtl. Fehler bzw. Auslassungen in den veröffentlichten Informationen ab.

MADE IN ITALY



AD project  
[www.puntodigital.it](http://www.puntodigital.it)

3D & photo  
[www.puntoimmaginesrl.it](http://www.puntoimmaginesrl.it)

# LISTINO GENERALE

COLLECTIONS  
2024

## Codici Prezzo 1° scelta - IVA Esclusa

Codeprice 1st choice - Preisgruppe 1. Wahl - Codeprix 1 ere choix

1.....	0,78	48.....	42,43	95.....	92,35
2.....	3,53	49.....	43,66	96.....	92,45
3.....	4,88	50.....	45,89	97.....	93,60
4.....	5,62	51.....	46,87	98.....	94,85
5.....	7,70	52.....	47,04	99.....	96,00
6.....	8,99	53.....	47,14	100.....	97,20
7.....	9,60	54.....	47,29	101.....	97,58
8.....	9,64	55.....	47,42	102.....	98,59
9.....	10,27	56.....	47,52	103.....	100,15
10.....	11,56	57.....	48,67	104.....	101,09
11.....	12,84	58.....	48,79	105.....	102,72
12.....	13,42	59.....	49,18	106.....	103,20
13.....	13,49	60.....	49,42	107.....	148,94
14.....	14,12	61.....	49,92	108.....	154,08
15.....	14,40	62.....	50,08	109.....	174,72
16.....	14,77	63.....	50,66	110.....	282,48
17.....	15,41	64.....	51,17	111.....	108,00
18.....	16,69	65.....	51,36	112.....	132,00
19.....	17,98	66.....	51,60	113.....	216,00
20.....	18,00	67.....	52,42	114.....	252,00
21.....	18,62	68.....	53,66	115.....	13,50
22.....	19,26	69.....	54,00	116.....	16,20
23.....	20,54	70.....	54,91	117.....	63,60
24.....	21,19	71.....	59,90	118.....	2,34
25.....	21,60	72.....	60,00	119.....	228,00
26.....	22,80	73.....	61,63	120.....	69,60
27.....	23,11	74.....	62,40	121.....	19,80
28.....	24,00	75.....	64,80	122.....	32,04
29.....	24,40	76.....	67,39	123.....	27,00
30.....	24,42	77.....	72,00	124.....	4,20
31.....	25,20	78.....	72,38	125.....	24,72
32.....	25,68	79.....	74,88	126.....	7,92
33.....	26,21	80.....	76,13	127.....	31,68
34.....	28,25	81.....	77,04	128.....	29,64
35.....	28,80	82.....	77,38	129.....	12,00
36.....	30,82	83.....	79,87	130.....	158,40
37.....	31,20	84.....	80,40	131.....	45,00
38.....	33,38	85.....	82,56	132.....	34,32
39.....	33,60	86.....	82,85	133.....	22,20
40.....	34,67	87.....	83,09	134.....	52,80
41.....	34,78	88.....	84,00	135.....	10,56
42.....	34,80	89.....	84,86	136.....	36,96
43.....	35,95	90.....	86,40	137.....	201,60
44.....	38,52	91.....	87,01	138.....	297,60
45.....	39,80	92.....	87,36	139.....	122,40
46.....	40,80	93.....	89,86	140.....	3,24
47.....	42,00	94.....	91,20	141.....	114,00

### Su listini e cataloghi

il codice prezzo su □ significa prezzo al mq.

il codice prezzo su ○ significa prezzo al pz.

il codice prezzo su △ significa prezzo al ml.

GAZZINI  
CERAMICA & DESIGN

"Campione gratuito di modico valore F.c. Iva art.2 3°comma Lettera d D.P.R. 633/72 succ. mod."

# GAZZINI

CERAMICA & DESIGN

Ceramica Gazzini SpA - via Milano, 2 - 42048 Rubiera (Reggio Emilia) Italy  
Tel. 0522 628112 - 627518 - 628639 - Fax 0522 628437  
info@ceramicagazzini.it - www.ceramicagazzini.it

C.F. E P.I. 00140380353 - REG. IMP. REGGIO EMILIA N° 00140380353  
CAPITALE SOCIALE I.V. € 546.000,00

